

ALTERNATOR DATASHEET

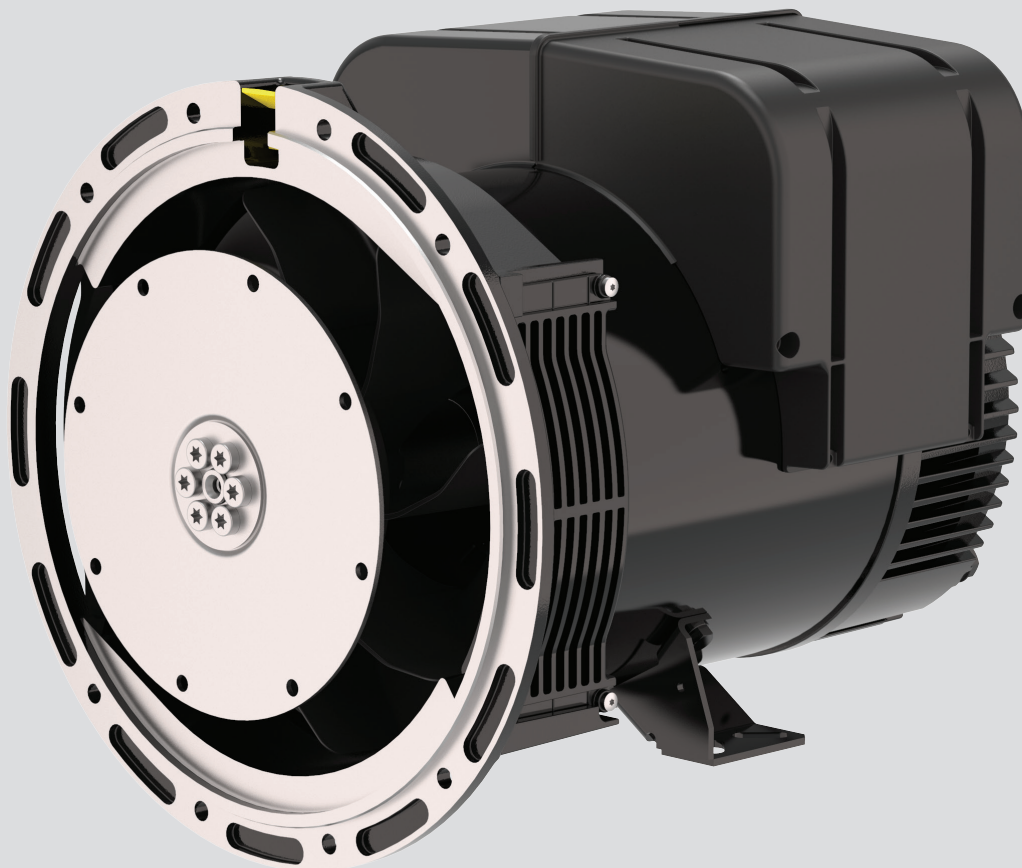



TAL 040

Low Voltage Alternator - 4 pole

Three-phase 10 to 20 kVA - 50 Hz / 12.5 to 25 kVA - 60 Hz
Dedicated single-phase 10.5 to 16 kVA - 50 Hz / 11.5 to 17.5 kVA - 60 Hz
Electrical and mechanical data

LEROY-SOMER[™]

Nidec
All for dreams

TAL 040 - Three-phase & Single-phase

The best of performance

Nidec Leroy-Somer TAL 040 alternator has been designed to offer you the best power generation performances. With its meticulous design and optimized architecture, the TAL 040 strikes the perfect balance between compactness, reliability, performance and longevity. Whatever your application, the TAL 040 will meet your needs and will adapt to all situations.

Standards

Nidec Leroy-Somer TAL 040 alternator meets all key international standards and regulations, including IEC 60034, NEMA MG 1.32-33, ISO 8528-3, CSA C22.2 n°100-14 and UL 1446 (UL 1004 on request). Also compliant with IEC 61000-6-2, IEC 61000-6-3, IEC 61000-6-4, VDE 0875G, VDE 0875N and EN 55011, group 1 class A for European zone. Nidec Leroy-Somer TAL 040 alternator can be integrated in EC marked generator set, and bears EC, UKCA and CMIM markings. It is designed, manufactured and marketed in an ISO 9001 and ISO 14001 quality assurance environment.

Electrical characteristics and performances

- Class H insulation
- Shunt excitation
- Low voltage winding:
 - Three-phase 50 Hz: 220V - 240V and 380V - 415V (440V)
60 Hz: 208V - 240V and 380V - 480V
 - Single-phase 50 Hz: 115V - 230V
60 Hz: 120V - 240V
- 4-terminal plates in 6-wire version
- Optimized performance

Excitation and regulation system

	Excitation system			Regulation options	
	AVR	SHUNT	AREP+ (option)	ULc/us	Remote voltage potentiometer
Three-phase 6-wire	R120	Standard			
	R150	Option			√
	R180		Standard		√
	D350	Option	Option	√	√
Three-phase 12-wire	R120	Standard			
	R220	Option		√	√
	R180		Standard		√
	D350	Option	Option	√	√
Single-phase	R121	Standard			√
	R221	Option		√	√

Protection system and options

- Degree of protection: IP 23
- Complete winding protection for non-harsh environment with relative humidity $\leq 95\%$
- Options:
 - Three-phase 12-wire with 8-terminal plates
 - AREP+ excitation
 - ULc/us
 - Customized painting (unpainted machine as standard)
 - Space heater
 - Flying leads
 - Dedicated single-phase
 - Winding 8 optimized for three-phase 380V / 416V - 60Hz
 - Reinforced winding protection for harsh environments and relative humidity greater than 95% (system 2 - 4 without derating)

Mechanical construction

- Compact and rugged assembly to withstand engine vibrations
- Steel frame
- Aluminum flanges and shields
- Single-bearing design compatible with most diesel engines
- Greased for life bearings
- Direction of rotation: clockwise and counterclockwise without derating

Terminal box design

- Easy access to AVR and terminals



TAL 040 - Three-phase 10 to 20 kVA - 50 Hz / 12.5 to 25 kVA - 60 Hz

General characteristics

Insulation class	H	Excitation system 6-wire	SHUNT	AREP+
Winding pitch	2/3 (wind.6S - 6-wire / wind.6 - 12-wire)	AVR type	R120	R180
Number of wires	6 (12 option)	Excitation system 12-wire (option)	SHUNT	AREP+
Protection	IP 23	AVR type	R120	R180
Altitude	≤ 1000 m	Voltage regulation (**)	± 1 %	± 0.5 %
Overspeed	2250 R.P.M.	Total Harmonic Distortion THD (***) in no-load	< 3.5 %	
Air flow 50 Hz	0.06 m³/s	Total Harmonic Distortion THD (***) in linear load	< 5 %	
Air flow 60 Hz	0.07 m³/s	Waveform: NEMA = TIF (***)	< 50	
AREP+ Short-circuit current = 2.7 In: 5 seconds (*)		Waveform: I.E.C. = FHT (***)	< 2%	

(*) D350: 10 seconds (**) Steady state (***) Total harmonic distortion between phases, no-load or on-load (non-distorting)

Ratings 50 Hz - 1500 R.P.M.

kVA / kW - P.F. = 0.8																					
Duty / T° C	Continuous / 40 °C					Continuous / 40 °C					Stand-by / 40 °C					Stand-by / 27 °C					
Class / T° K	H / 125° K					F / 105° K					H / 150° K					H / 163° K					
Phase	3 ph.			1 ph.		3 ph.			1 ph.		3 ph.			1 ph.		3 ph.			1 ph.		
Y	380V	400V	415V	440V		380V	400V	415V	440V		380V	400V	415V	440V		380V	400V	415V	440V		
Δ	220V	230V	240V		230V	220V	230V	240V		230V	220V	230V	240V		230V	220V	230V	240V		230V	
YY (*)		200V		220V			200V		220V			200V		220V			200V		220V		
ΔΔ (*)					230V					230V					230V					230V	
TAL 040 B	kVA	10	10	10	9	7	9	9	9	8	6.5	10.5	10.5	10.5	9.5	7.5	11	11	11	10	7.5
	kW	8	8	8	7	5.5	7	7	7	6.5	5	8.5	8.5	8.5	7.5	6	9	9	9	8	6
TAL 040 C	kVA	12.5	12.5	12.5	11	9	11.5	11.5	11.5	10	8	13.5	13.5	13.5	11.5	9.5	14	14	14	12	10
	kW	10	10	10	9	7	9	9	9	8	6.5	11	11	11	9	7.5	11	11	11	9.5	8
TAL 040 D	kVA	15	15	15	13	10.5	14	14	14	12	9.5	16	16	16	14	11	16.5	16.5	16.5	14.5	11.5
	kW	12	12	12	10.5	8.5	11	11	11	9.5	7.5	13	13	13	11	9	13	13	13	11.5	9
TAL 040 E	kVA	17.5	17.5	17.5	16	12.5	16	16	16	14.5	11.5	18.5	18.5	18.5	17	13.5	19.5	19.5	19.5	17.5	14
	kW	14	14	14	13	10	13	13	13	11.5	9	15	15	15	13.5	11	15.5	15.5	15.5	14	11
TAL 040 F	kVA	20	20	20	18	14	18	18	18	16.5	13	21	21	21	19	15	22	22	22	20	15.5
	kW	16	16	16	14.5	11	14.5	14.5	14.5	13	10.5	17	17	17	15	12	17.5	17.5	17.5	16	12.5

(*) 12-wire option

Ratings 60 Hz - 1800 R.P.M.

kVA / kW - P.F. = 0.8																					
Duty / T° C	Continuous / 40 °C					Continuous / 40 °C					Stand-by / 40 °C					Stand-by / 27 °C					
Class / T° K	H / 125° K					F / 105° K					H / 150° K					H / 163° K					
Phase	3 ph.			1 ph.		3 ph.			1 ph.		3 ph.			1 ph.		3 ph.			1 ph.		
Y	380V	416V	440V	480V		380V	416V	440V	480V		380V	416V	440V	480V		380V	416V	440V	480V		
Δ	220V	240V			240V	220V	240V			240V	220V	240V			240V	220V	240V			240V	
YY (*)		208V	220V	240V			208V	220V	240V			208V	220V	240V			208V	220V	240V		
ΔΔ (*)					240V					240V					240V					240V	
TAL 040 B	kVA	10	11	11.5	12.5	9	9	10	10.5	11.5	8	10.5	11.5	12	13.5	9.5	11	12	12.5	14	10
	kW	8	9	9	10	7	7	8	8.5	9	6.5	8.5	9	9.5	11	7.5	9	9.5	10	11	8
TAL 040 C	kVA	12.5	13.5	14.5	15.5	11.5	11.5	12.5	13	14	10.5	13.5	14.5	15.5	16.5	12	14	15	16	17	12.5
	kW	10	11	11.5	12.5	9	9	10	10.5	11	8.5	11	11.5	12.5	13	9.5	11	12	13	13.5	10
TAL 040 D	kVA	15	16.5	17.5	19	13	13.5	15	16	17.5	12	16	17.5	18.5	20	14	16.5	18	19.5	21	14.5
	kW	12	13	14	15	10.5	11	12	13	14	9.5	13	14	15	16	11	13	14.5	15.5	17	11.5
TAL 040 E	kVA	17.5	19	20	22	14.5	16	17.5	18	20	13	18.5	20	21	23.5	15.5	19.5	21	22	24	16
	kW	14	15	16	17.5	11.5	13	14	14.5	16	10.5	15	16	17	19	12.5	15.5	17	17.5	19	13
TAL 040 F	kVA	20	22	23	25	16	18	20	21	23	14.5	21	23.5	24.5	26.5	17	22	24	25.5	27.5	17.5
	kW	16	17.5	18.5	20	13	14.5	16	17	18.5	11.5	17	19	19.5	21	13.5	17.5	19	20.5	22	14

(*) 12-wire option

TAL 040 - Three-phase 10 to 20 kVA - 50 Hz / 12.5 to 25 kVA - 60 Hz

Efficiencies 400 V - 50 Hz (— P.F.: 0.8) (--- P.F.: 1)

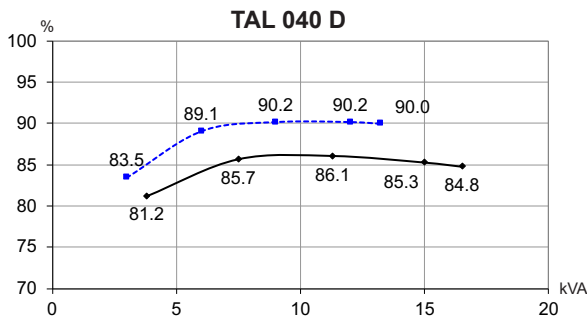
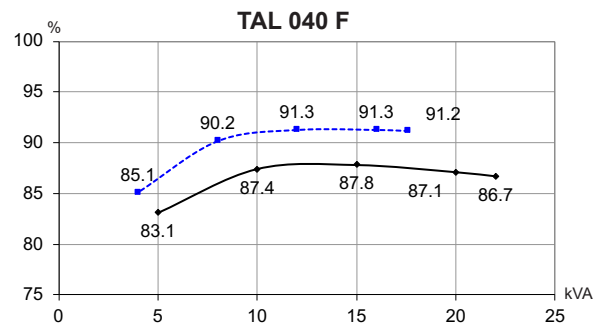
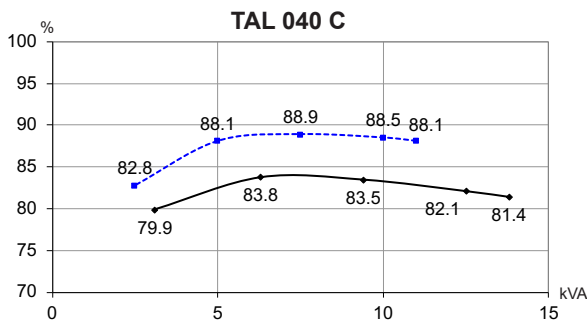
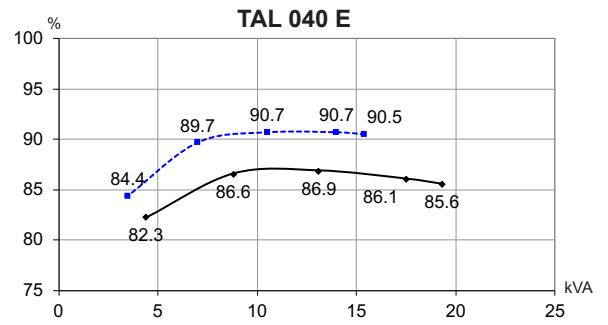
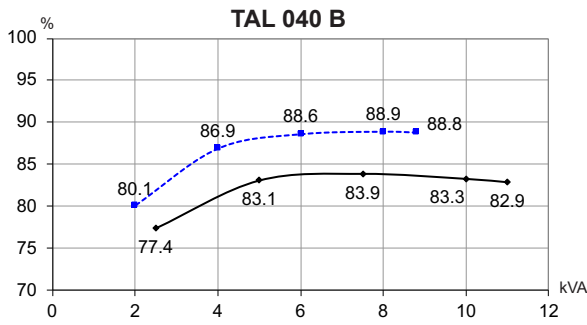

Reactances (%). Time constants (ms) - Class H / 400 V

	B	C	D	E	F
Kcc Short-circuit ratio	0.7	0.56	0.6	0.6	0.61
Xd Direct-axis synchronous reactance unsaturated	167	209	190	195	193
Xq Quadrature-axis synchronous reactance unsaturated	85	106	97	99	98
T'do No-load transient time constant	719	719	837	878	926
X'd Direct-axis transient reactance saturated	17.2	21.5	16.8	16.4	15.4
T'd Short-circuit transient time constant	74	74	74	74	74
X''d Direct-axis subtransient reactance saturated	8.6	10.7	8.4	8.2	7.7
T''d Subtransient time constant	7	7	7.4	7	7
X''q Quadrature-axis subtransient reactance saturated	16.1	20.1	16.8	16.8	16.2
Xo Zero sequence reactance	0.71	0.89	0.7	0.68	0.64
X2 Negative sequence reactance saturated	12.36	15.45	12.66	12.55	12.01
Ta Armature time constant	11	11	11	11	11

Other class H / 400 V data

	B	C	D	E	F
io (A) No-load excitation current SHUNT/AREP+	0.77 / 1.06	0.77 / 1.06	0.76 / 1.03	0.75 / 1.03	0.72 / 0.98
ic (A) On-load excitation current SHUNT/AREP+	1.94 / 2.65	2.30 / 3.14	2.05 / 2.79	2.06 / 2.80	1.95 / 2.66
uc (V) On-load excitation voltage SHUNT/AREP+	23.7 / 17.1	28 / 20.2	24.9 / 17.9	24.9 / 18	23.6 / 17
ms Response time ($\Delta U = 20\%$ transient)	500	500	500	500	500
kVA Start ($\Delta U = 20\%$ cont. or $\Delta U = 30\%$ trans.) SHUNT*	18.3	18.3	28	33.6	40.8
kVA Start ($\Delta U = 20\%$ cont. or $\Delta U = 30\%$ trans.) AREP+*	22	22	34	41	50
% Transient ΔU (on-load 4/4) SHUNT - P.F.: 0.8 _{LAG}	18	20.5	17.8	17.5	16.9
% Transient ΔU (on-load 4/4) AREP+ - P.F.: 0.8 _{LAG}	16	18.2	15.8	15.6	15.1
W No-load losses	461	461	540	590	645
W Heat dissipation	1597	2172	2063	2255	2352

* P.F. = 0.6

Transient voltage variation 400V - 50 Hz

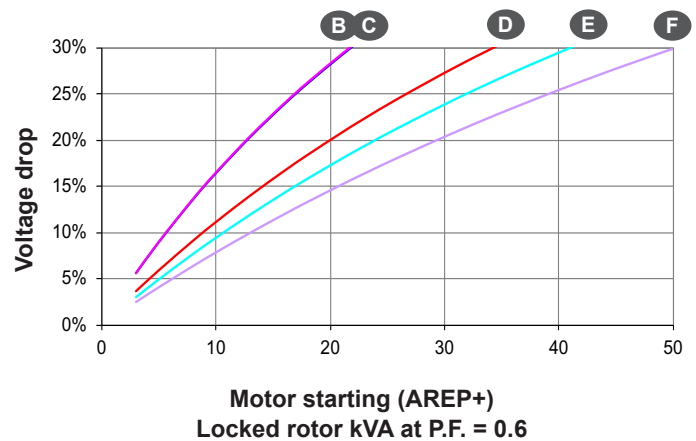
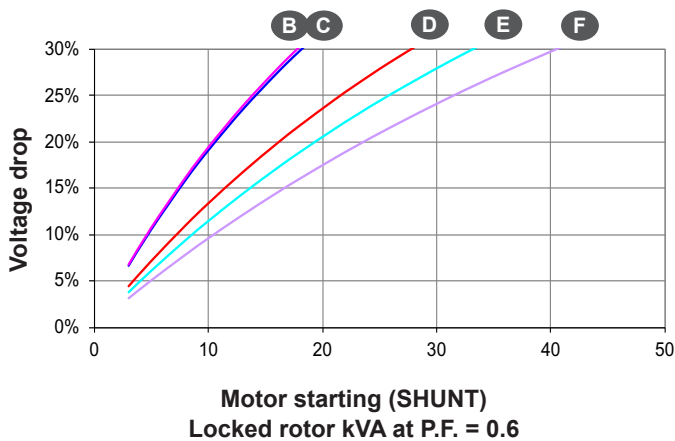
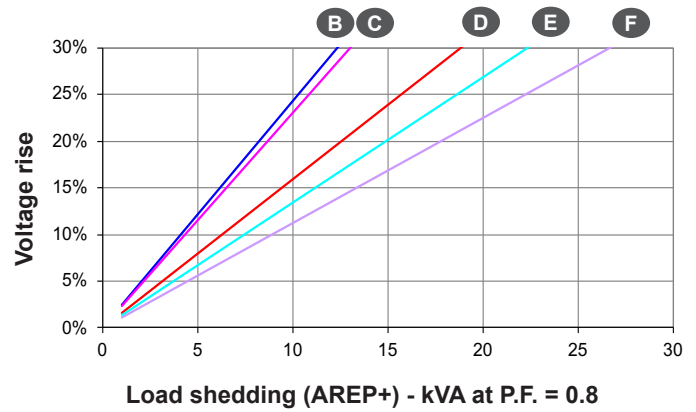
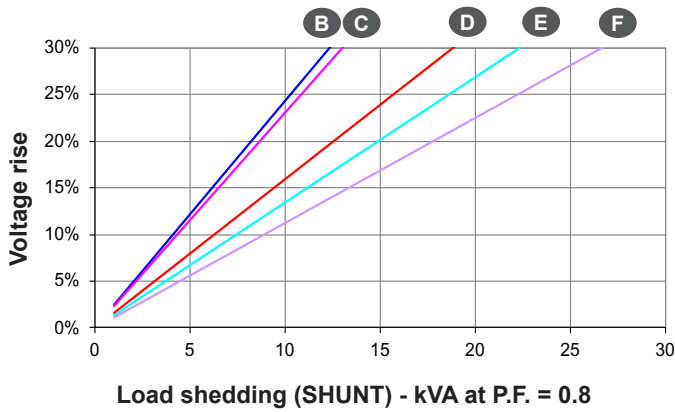
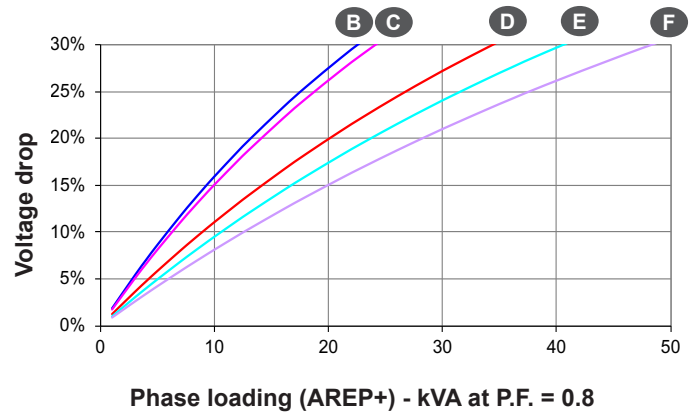
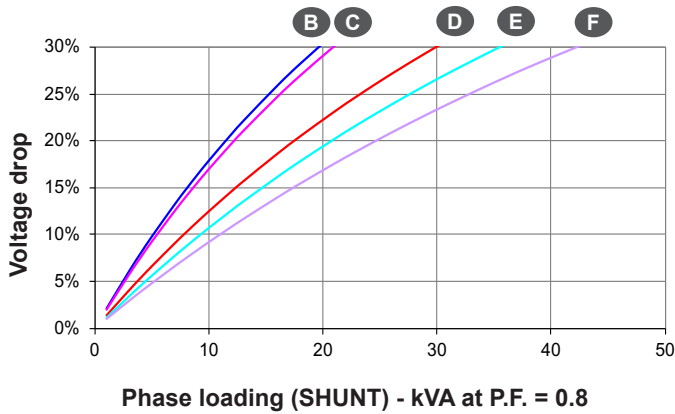

- For a starting P.F. other than 0.6, the starting kVA must be multiplied by $K = \text{Sine P.F.} / 0.8$
- For voltages other than 400V (Y), 230V (Δ) at 50 Hz, then kVA must be multiplied by $(400/U)^2$ or $(230/U)^2$.

Efficiencies 480 V - 60 Hz (— P.F.: 0.8) (--- P.F.: 1)

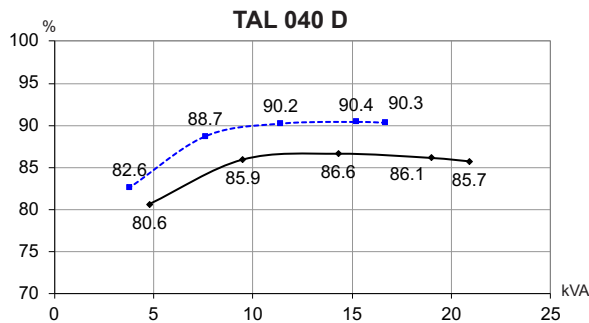
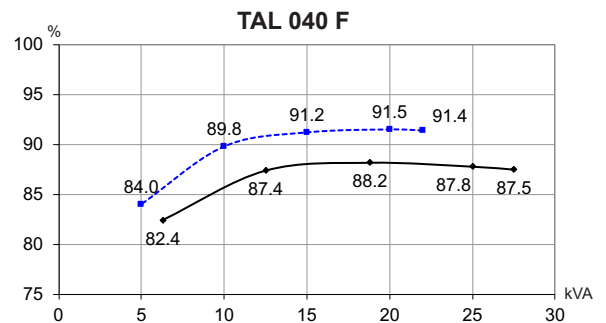
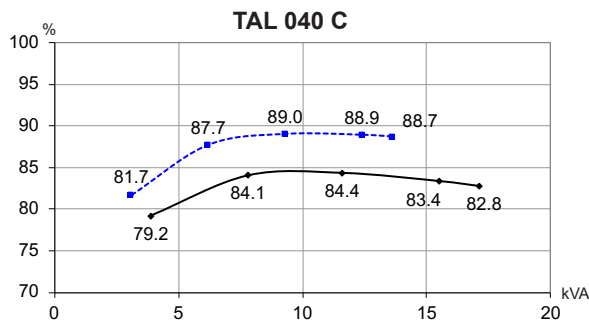
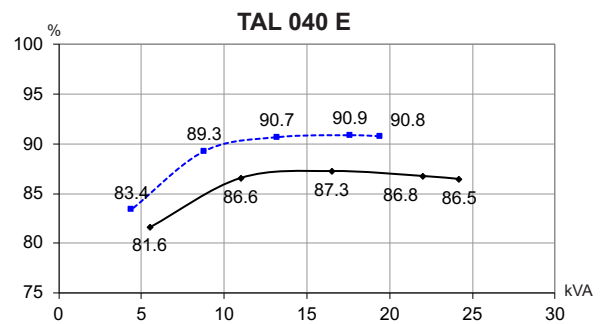
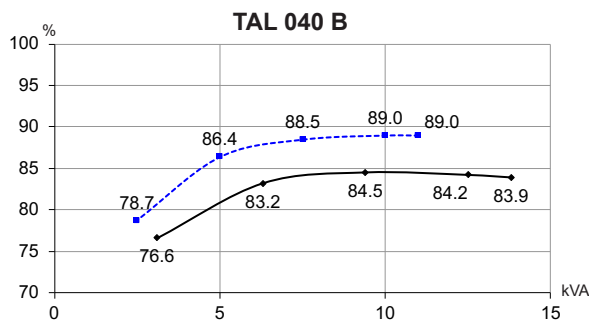

Reactances (%). Time constants (ms) - Class H / 480 V

		B	C	D	E	F
Kcc	Short-circuit ratio	0.67	0.54	0.57	0.57	0.58
Xd	Direct-axis synchronous reactance unsaturated	174	216	201	204	201
Xq	Quadrature-axis synchronous reactance unsaturated	88	110	102	104	102
T'do	No-load transient time constant	719	719	837	878	926
X'd	Direct-axis transient reactance saturated	17.9	22.2	17.8	17.2	16.1
T'd	Short-circuit transient time constant	74	74	74	74	74
X''d	Direct-axis subtransient reactance saturated	8.9	11.1	8.9	8.6	8
T''d	Subtransient time constant	7	7	7.4	7	7
X''q	Quadrature-axis subtransient reactance saturated	16.7	20.7	17.8	17.6	16.9
Xo	Zero sequence reactance	0.74	0.92	0.74	0.71	0.67
X2	Negative sequence reactance saturated	12.87	15.96	13.36	13.15	12.51
Ta	Armature time constant	11	11	11	11	11

Other class H / 480 V data

		B	C	D	E	F
io (A)	No-load excitation current SHUNT/AREP+	0.77 / 1.06	0.77 / 1.06	0.76 / 1.03	0.75 / 1.02	0.72 / 0.98
ic (A)	On-load excitation current SHUNT/AREP+	1.97 / 2.69	2.33 / 3.17	2.10 / 2.86	2.10 / 2.86	1.97 / 2.69
uc (V)	On-load excitation voltage SHUNT/AREP+	24.1 / 17.4	28.4 / 20.5	25.6 / 18.5	25.5 / 18.4	24 / 17.3
ms	Response time ($\Delta U = 20\%$ transient)	500	500	500	500	500
kVA	Start ($\Delta U = 20\%$ cont. or $\Delta U = 30\%$ trans.) SHUNT*	21.9	22	33.6	40.3	48.9
kVA	Start ($\Delta U = 20\%$ cont. or $\Delta U = 30\%$ trans.) AREP+*	27	27	41	49	60
%	Transient ΔU (on-load 4/4) SHUNT - P.F.: 0.8 _{LAG}	18.4	20.9	18.3	18	17.3
%	Transient ΔU (on-load 4/4) AREP+ - P.F.: 0.8 _{LAG}	16.4	18.5	16.3	16	15.4
W	No-load losses	643	643	755	825	904
W	Heat dissipation	1866	2464	2447	2654	2763

* P.F. = 0.6

Transient voltage variation 480V - 60 Hz

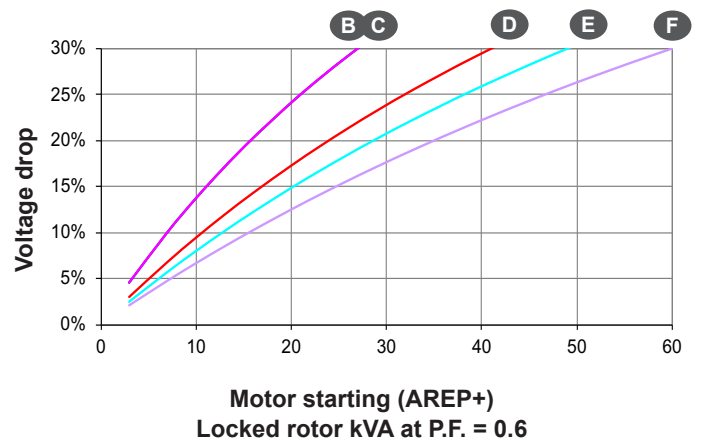
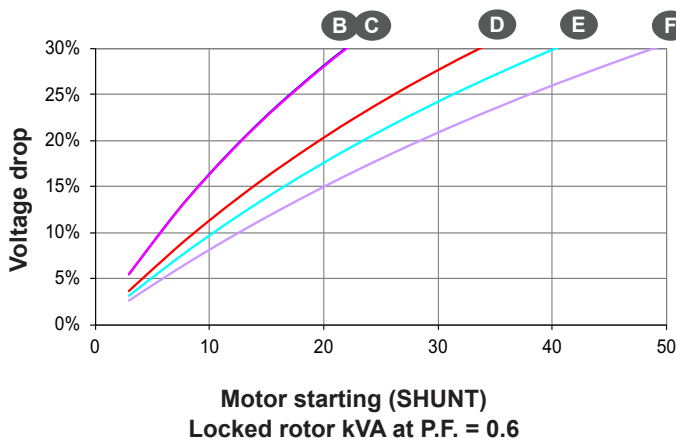
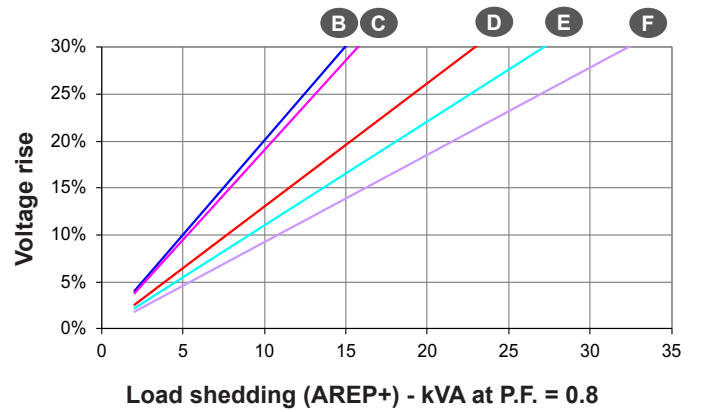
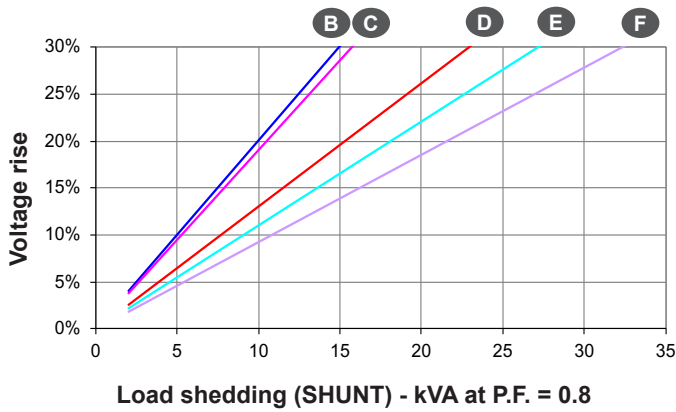
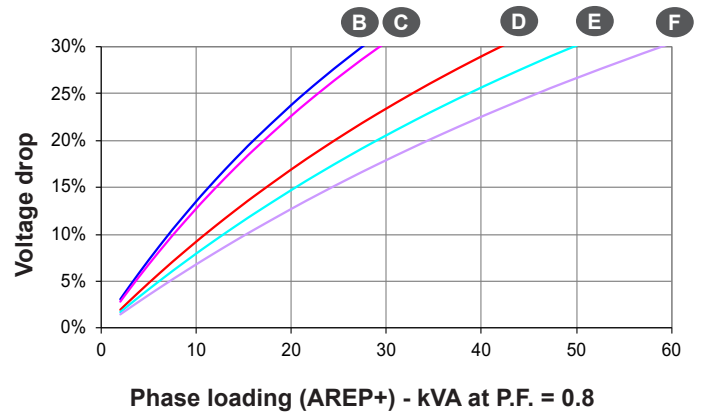
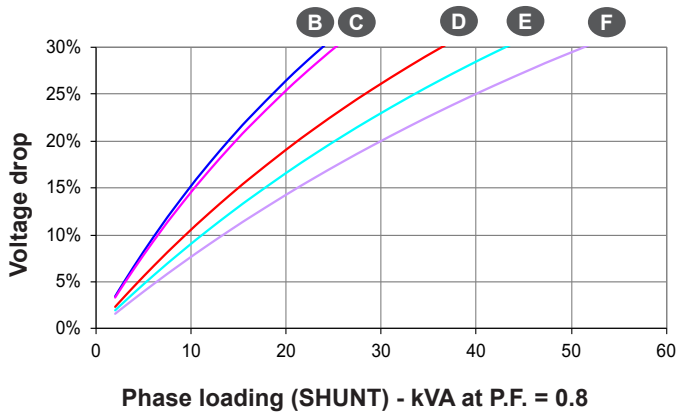

- For a starting P.F. other than 0.6, the starting kVA must be multiplied by $K = \text{Sine P.F.} / 0.8$
- For voltages other than 480V (Y), 277V (Δ), 240V (YY) at 60 Hz, then kVA must be multiplied by $(480/U)^2$ or $(277/U)^2$ or $(240/U)^2$.

3-phase short-circuit curves at no load and rated speed (star connection Y)

TAL 040 B

Symmetrical —
Asymmetrical - - -

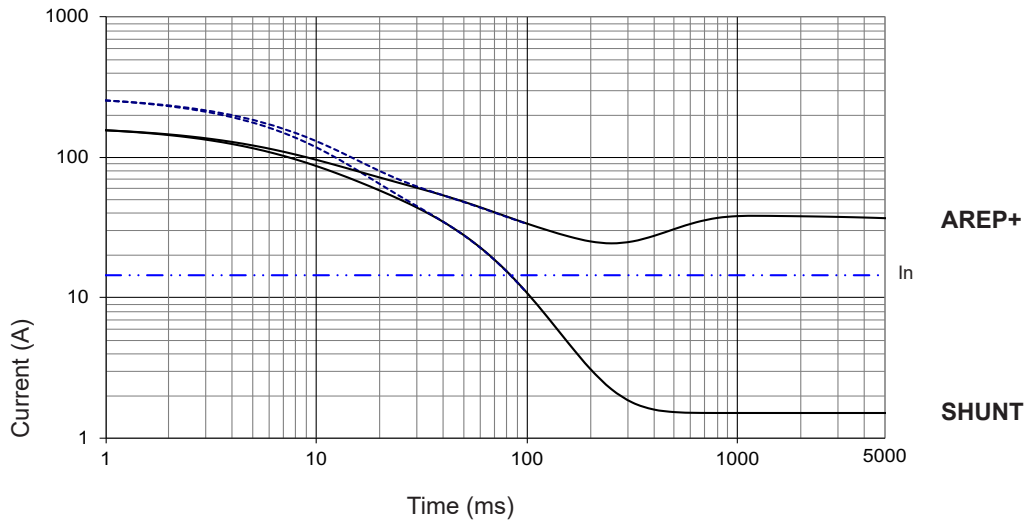

TAL 040 C

Symmetrical —
Asymmetrical - - -

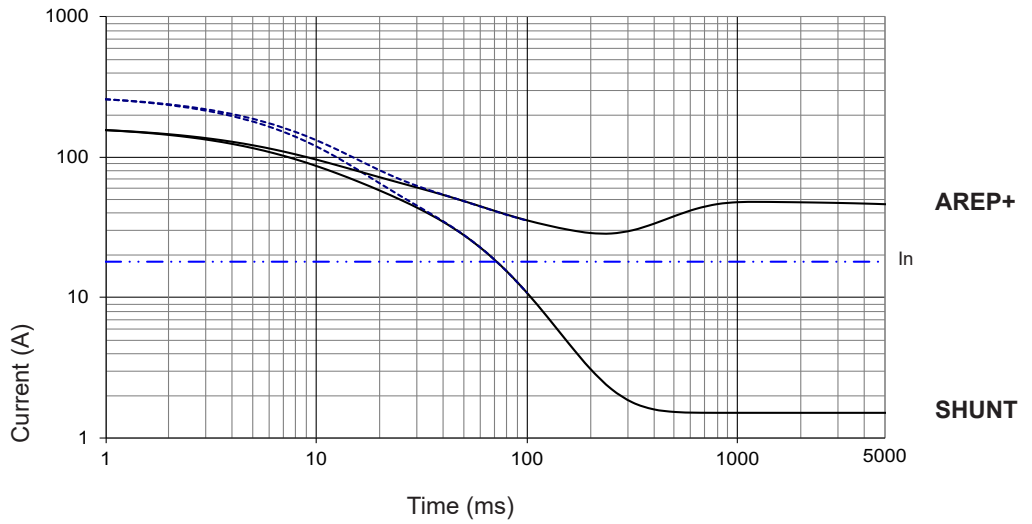

TAL 040 D

Symmetrical —
Asymmetrical - - -

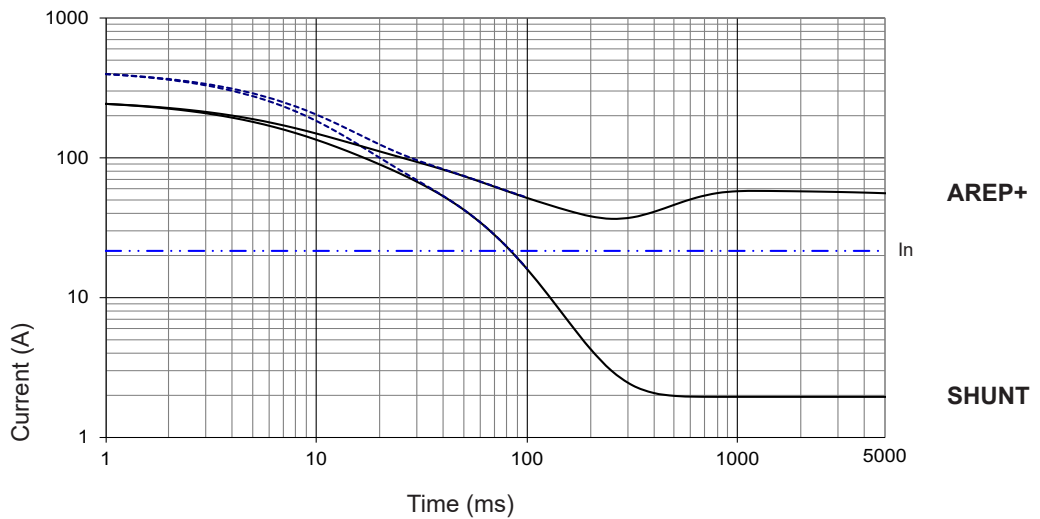

Influence due to connection

For (Δ) connection, use the following multiplication factor:
- Current value x 1.732.

3-phase short-circuit curves at no load and rated speed (star connection Y)

TAL 040 E

Symmetrical —
Asymmetrical - - -

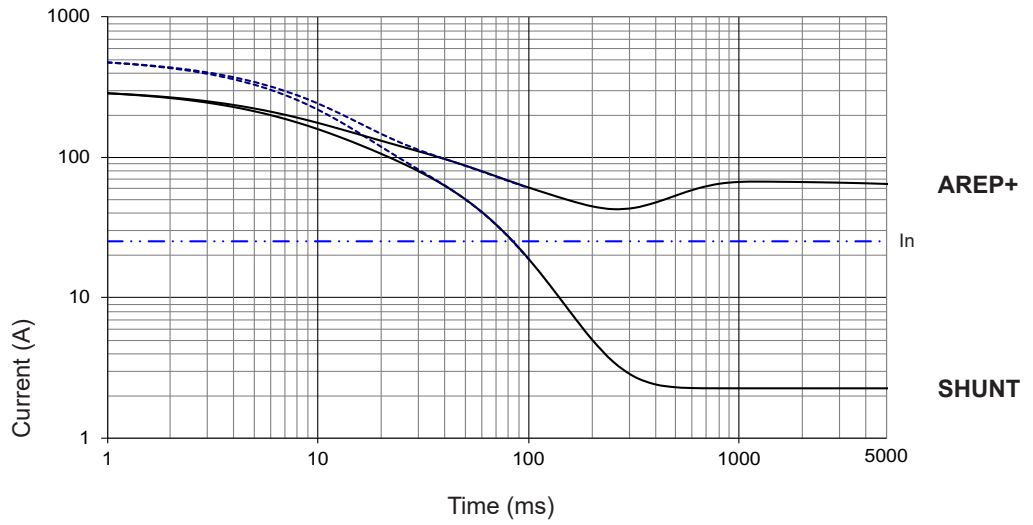

TAL 040 F

Symmetrical —
Asymmetrical - - -

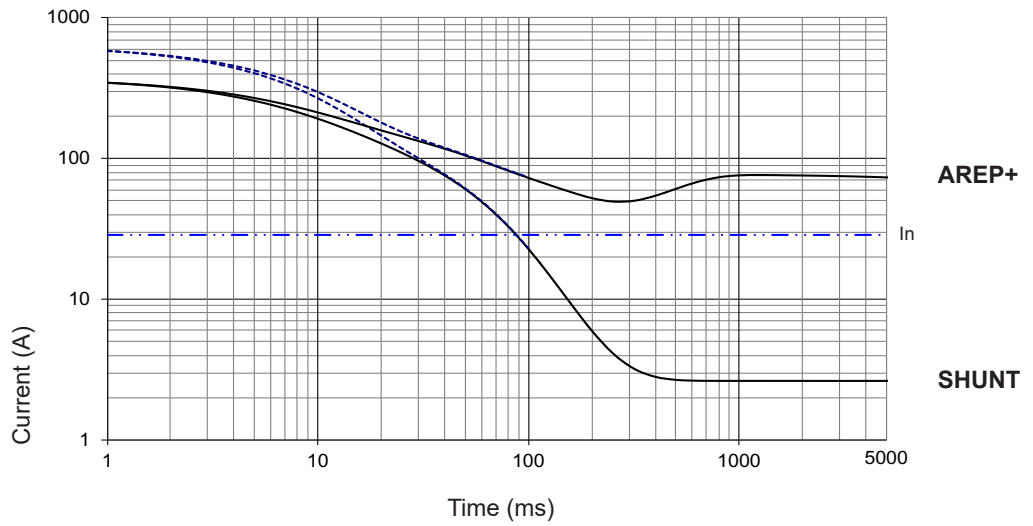

Influence due to short-circuit

Curves are based on a three-phase short-circuit.
For other types of short-circuit,
use the following multiplication factors.

	3 - phase	2 - phase L / L	1 - phase L / N
Instantaneous (max.)	1	0.87	1.3
Continuous	1	1.5	2.2
Maximum duration (AREP+)	1	1.5	



TAL 040 - Dedicated single-phase 10.5 to 16 kVA - 50 Hz / 11.5 to 17.5 kVA - 60 Hz

General characteristics

Insulation class	H	Excitation system	SHUNT
Winding pitch	2/3 (wind. M)	AVR type	R121
Number of wires	4	Voltage regulation (*)	± 1 %
Protection	IP 23	Total Harmonic Distortion THD (**) in no-load	< 3.5 %
Altitude	≤ 1000 m	Total Harmonic Distortion THD (**) in linear load	< 5 %
Overspeed	2250 R.P.M.	Waveform: NEMA = TIF (**)	< 100
Air flow	0.06 m³/s (50 Hz) / 0.07 m³/s (60 Hz)	Waveform: I.E.C. = FHT (**)	< 2 %



(*) Steady state (**) Total harmonic distortion between phases, no-load or on-load (non-distorting)

Ratings / Efficiencies 50 Hz - 1500 R.P.M.

kVA / kW - P.F. = 1(*)						
Duty / T° C	Continuous / 40 °C			Stand-by / 40 °C	Stand-by / 27 °C	
Class / T° K	H / 125° K	F / 105° K	H / 150° K	H / 163° K		
Serie (SE) 	230 V	η %	230 V	230 V	230V	η %
Parallel (PA) 	115 V	η %	115 V	115 V	115 V	η %
TAL 040 C	10.5	82.4	9.5	11	11.5	81.2
TAL 040 C1	12	84.5	11	12.5	13	83.7
TAL 040 D	13	85.4	12	14	14.5	84.7
TAL 040 E	14.5	86.3	13	15.5	16	85.6
TAL 040 F	16	87.3	14.5	17	17.5	86.7

(*) For P.F. 0.8: derating 15%

Ratings / Efficiencies 60 Hz - 1800 R.P.M.

kVA / kW - P.F. = 1(*)						
Duty / T° C	Continuous / 40 °C			Stand-by / 40 °C	Stand-by / 27 °C	
Class / T° K	H / 125° K	F / 105° K	H / 150° K	H / 163° K		
Serie (SE) 	240 V	η %	240 V	240 V	240V	η %
Parallel (PA) 	120 V	η %	120 V	120 V	120 V	η %
TAL 040 C	11.5	82.6	10.5	12	12.5	81.7
TAL 040 C1	13.5	84.2	12.5	14.5	15	83.4
TAL 040 D	14.5	85	13	15.5	16	84.3
TAL 040 E	16	85.9	14.5	17	17.5	85.3
TAL 040 F	17.5	86.9	16	18.5	19.5	86.3

(*) For P.F. 0.8: derating 15%

Starting motor 230V - 50Hz

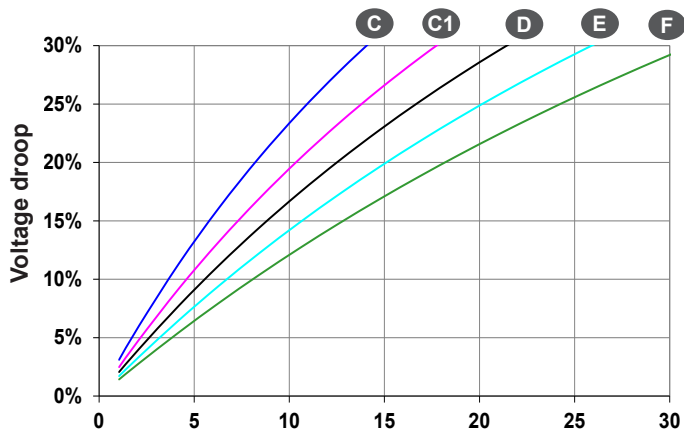

Starting motor 240V - 60Hz

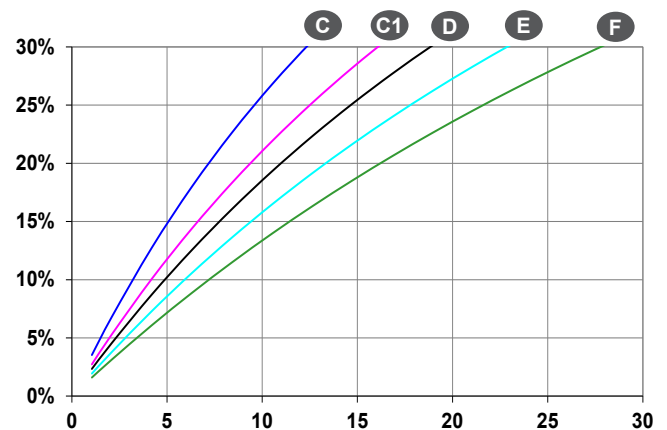

Locked rotor kVA at PF : 0.9

TAL 040 - Three-phase & Single-phase

Single-bearing dimensions

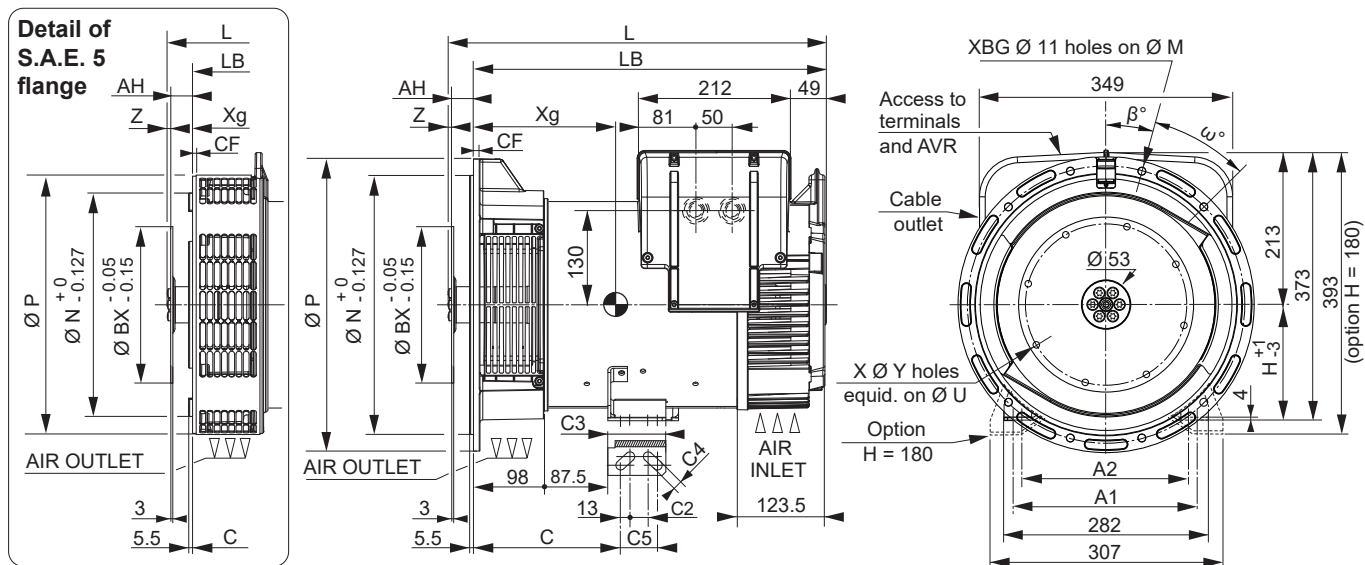

Dimensions (mm) and weight

Type	L maxi*	LB	Xg	Weight (kg)
TAL 040 B	469	407	186	73
TAL 040 C	469	407	186	73
TAL 040 C1	469	407	196	80
TAL 040 D	499	437	204	87
TAL 040 E	499	437	221	92
TAL 040 F	519	457	221	102

* L maxi = LB + AH maxi + Z

Shaft height (mm)

H	Feet length	
	Standard	Option
H	160	180
C	203	238
C2	25	22
C3	80	60
C4	13	12
C5	51	22
A1	254	279
A2	230	-

Coupling

Flange Flex plate	Coupling		
	3	4	5
11 ½	x	-	-
10	x	x	-
8	x	x	-
7 ½	-	x	x
6 ½	-	x	x

Flange (mm)

S.A.E.	P	N	M	XBG	β°	ω°	CF
5	358	314.32	333.38	8	22°30'	45°	11
4	408	361.95	381	8*	15°	30°	9
3	460	409.58	428.62	8*	15°	30°	12

* Four lateral holes removal on S.A.E. 3 and 4

Flex plate (mm)

S.A.E.	BX	U	X	Y	AH	Z
11 ½	352.42	333.38	8	11	39.6	0
10	314.32	295.28	8	11	53.8	0
8	263.52	244.48	6	11	62	0
7 ½	241.3	222.25	8	9	30.2	6
6 ½	215.9	200.02	6	9	30.2	6

Torsional analysis data

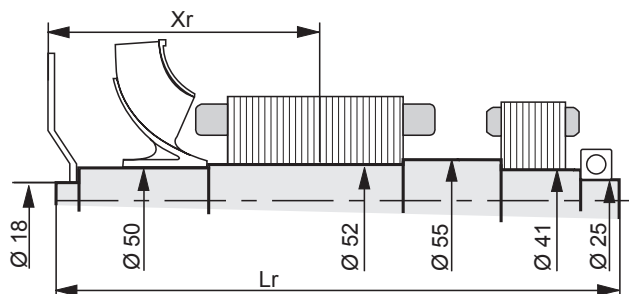

Centre of gravity: Xr (mm), Rotor length: Lr (mm), Weight: M (kg), Moment of inertia: J (kgm²): (4J = MD²)

Flex plate	S.A.E. 6 ½				S.A.E. 7 ½				S.A.E. 8				S.A.E. 10				
	Type	Xr	Lr	M	J	Xr	Lr	M	J	Xr	Lr	M	J	Xr	Lr	M	J
TAL 040 B		211.7	428	25.5	0.078	211.7	428	25.7	0.080	243.5	428	26	0.085	238.3	428	26.5	0.096
TAL 040 C		211.7	428	25.5	0.078	211.7	428	25.7	0.080	243.5	428	26	0.085	238.3	428	26.5	0.096
TAL 040 C1		221.7	428	27.9	0.087	221.7	428	28.1	0.089	253.5	428	28.4	0.094	248.3	428	28.9	0.105
TAL 040 D		229.2	458	30.3	0.094	229.2	458	30.5	0.096	261	458	30.8	0.100	255.8	458	31.3	0.112
TAL 040 E		236.7	458	32.2	0.100	236.7	458	32.4	0.103	268.5	458	32.7	0.107	263.3	458	33.2	0.119
TAL 040 F		246.7	478	35.3	0.110	246.7	478	35.4	0.113	278.5	478	35.7	0.117	273.3	478	36.2	0.129

NOTE : Dimensions are for information only and may be subject to modifications. The torsional analysis of the transmission is imperative. All values are available upon request.

LEROY-SOMER[™]

www.leroy-somer.com/epg

Connect with us at:



Nidec
All for dreams

© 2023 Moteurs Leroy-Somer SAS. The information contained in this brochure is for guidance only and does not form part of any contract. The accuracy cannot be guaranteed as Moteurs Leroy-Somer SAS have an ongoing process of development and reserve the right to change the specification of their products without notice.

Moteurs Leroy-Somer SAS. Headquarters: Bd Marcellin Leroy, CS 10015, 16915 Angoulême Cedex 9, France. Share Capital: 32,239,235 €, RCS Angoulême 338 567 258.