

ALTERNATOR DATASHEET

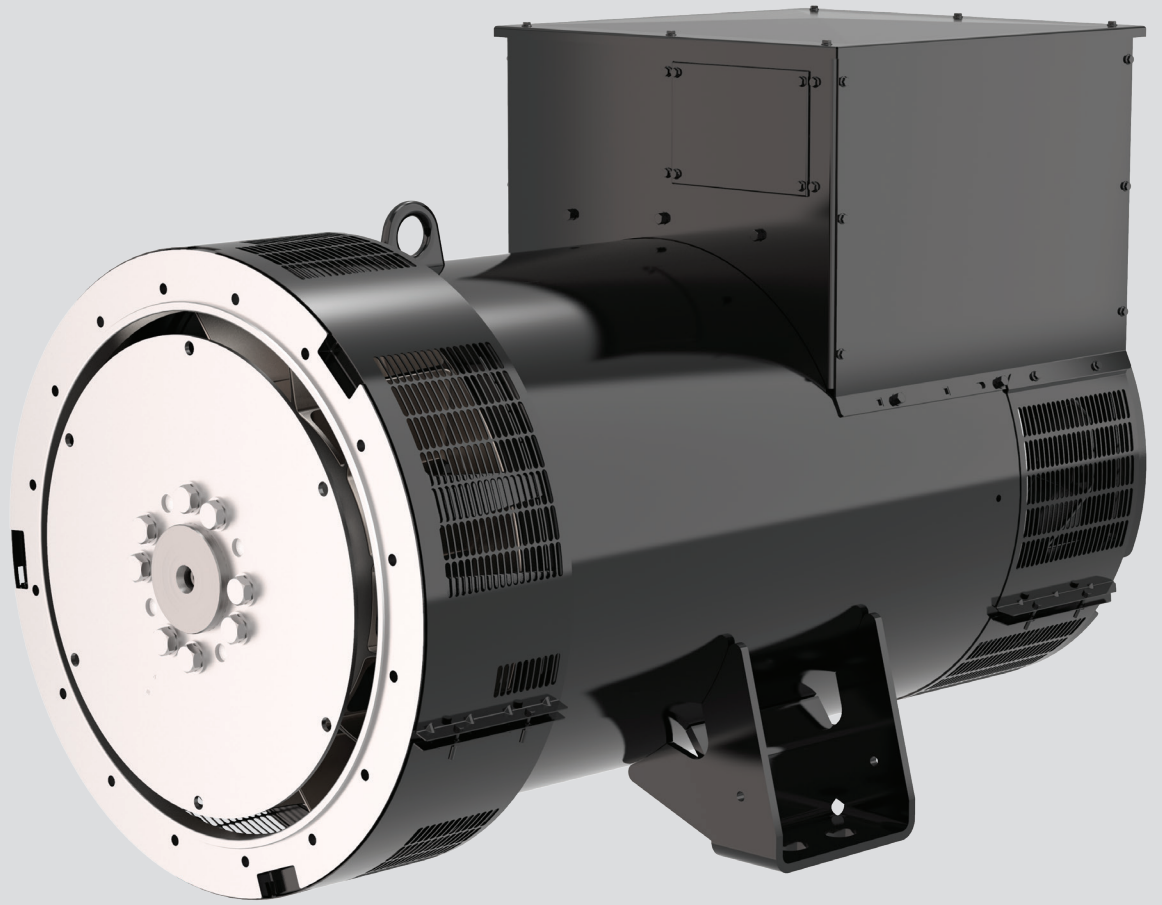



TAL 049

Low Voltage Alternator - 4 pole

730 to 1000 kVA - 50 Hz / 915 to 1250 kVA - 60 Hz
Electrical and mechanical data

LEROY-SOMER[™]

Nidec
All for dreams

The best of performance

Nidec Leroy-Somer TAL 049 alternator has been designed to offer you the best power generation performances. With its meticulous design and optimized architecture, the TAL 049 strikes the perfect balance between compactness, reliability, performance and longevity. Whatever your application, the TAL 049 will meet your needs and will adapt to all situations.

Standards

Nidec Leroy-Somer TAL 049 alternator meets all key international standards and regulations, including IEC 60034, NEMA MG 1.32-33, ISO 8528-3, CSA C22.2 n° 100-14 and UL 1446 (UL 1004 on request). Also compliant with IEC 61000-6-2, IEC 61000-6-3, IEC 61000-6-4, VDE 0875G, VDE 0875N and EN 55011, group 1 class A for European zone. Nidec Leroy-Somer TAL 049 alternator can be integrated in EC marked generator set, and bears EC, EAC and CMIM markings. It is designed, manufactured and marketed in an ISO 9001 and ISO 14001 quality assurance environment.

Electrical characteristics and performances

- Class H insulation
- Shunt excitation
- Low voltage winding:
 - Three-phase 50 Hz: 220V - 240V and 380V - 415V (440V)
 - 60 Hz: 208V - 240V and 380V - 480V
- 6-terminal plates in 6-wire version or suitable for 12-wire option
- Optimized performance

Excitation and regulation system

	Excitation system				Regulation options		
	AVR	SHUNT	AREP+ (option)	PMG (option)	UL _{C/US}	Remote voltage potentiometer	C.T. Current transformer for paralleling
Three-phase 6-wire	R150	Standard				√	
	R180		Standard	Standard		√	√
	D350	Option	Option	Option	√	√	√*
Three-phase 12-wire	R150	Standard				√	
	R250	Option			√	√	
	R180		Standard	Standard		√	√
	D350	Option	Option	Option	√	√	√*

*: only with AREP+ or PMG

Protection system and options

- Degree of protection: IP 23
- Complete winding protection for non-harsh environments with relative humidity ≤ 95%
- Options:
 - Three-phase 12-wire with 7-terminal plates
 - AREP+ or PMG excitation
 - UL_{C/US}
 - Customized painting (unpainted machine as standard)
 - Space heater
 - Droop kit for alternator paralleling
 - Stator sensors
 - Winding 8 optimized for three-phase 380V / 416V - 60 Hz
 - Reinforced winding protection for harsh environments and relative humidity greater than 95% (system 2 - 4 without derating)

Mechanical construction

- Compact and rugged assembly to withstand engine vibrations
- Steel frame
- Cast iron flanges and shields
- Single-bearing design to be suitable with most diesel engines
- Greased for life bearings
- Standard direction of rotation: clockwise when looking at the drive end view (for anti-clockwise, derate the machine by 5%)

Terminal box design

- Easy access to AVR and terminals
- Standard terminal box with possibility of mounting measurement CTs
- Possibility of current transformer for parallel operation



General characteristics

Insulation class	H	Excitation system 6-wire	SHUNT	AREP+ / PMG
Winding pitch	2/3 (wind.6S - 6-wire / wind.6 - 12-wire)	AVR type	R150	R180
Number of wires	6 (12 option)	Excitation system 12-wire (option)	SHUNT	AREP+ / PMG
Protection	IP 23	AVR type	R150	R180
Altitude	≤ 1000 m	Voltage regulation (**)	± 0.8 %	± 0.5 %
Overspeed	2250 R.P.M.	Total Harmonic Distortion THD (***) in no-load	< 3.5 %	
Air flow 50 Hz	1 m ³ /s	Total Harmonic Distortion THD (***) in linear load	< 5 %	
Air flow 60 Hz	1.2 m ³ /s	Waveform: NEMA = TIF (***)	< 50	
AREP+/PMG Short-circuit current = 2.7 In : 5 seconds (*)		Waveform: I.E.C. = THF (***)	< 2%	

(*) D350: 10 seconds (**) Steady state (***) Total harmonic distortion between phases, no-load or on-load (non-distorting)

Ratings 50 Hz - 1500 R.P.M.

kVA / kW - P.F. = 0.8																
Duty / T° C	Continuous / 40 °C				Continuous / 40 °C				Stand-by / 40 °C				Stand-by / 27 °C			
Class / T° K	H / 125° K				F / 105° K				H / 150° K				H / 163° K			
Phase	3 ph.				3 ph.				3 ph.				3 ph.			
Y	380V	400V	415V	440V	380V	400V	415V	440V	380V	400V	415V	440V	380V	400V	415V	440V
Δ	220V	230V	240V		220V	230V	240V		220V	230V	240V		220V	230V	240V	
YY (*)		200V	220V			200V	220V			200V	220V			200V	220V	
TAL 049 B kVA	730	730	730	665	665	665	665	605	775	775	775	705	805	805	805	730
kW	584	584	584	532	532	532	532	484	620	620	620	564	644	644	644	584
TAL 049 C kVA	820	820	820	810	745	745	745	735	870	870	870	860	910	910	910	890
kW	656	656	656	648	596	596	596	588	696	696	696	688	728	728	728	712
TAL 049 D kVA	910	910	910	820	830	830	830	745	965	965	965	870	1010	1010	1010	900
kW	728	728	728	656	664	664	664	596	772	772	772	696	808	808	808	720
TAL 049 E kVA	1000	1000	1000	950	910	910	910	865	1060	1060	1060	1005	1100	1100	1100	1045
kW	800	800	800	760	728	728	728	692	848	848	848	804	880	880	880	836

(*) 12-wire option

Ratings 60 Hz - 1800 R.P.M.

kVA / kW - P.F. = 0.8																
Duty / T° C	Continuous / 40 °C				Continuous / 40 °C				Stand-by / 40 °C				Stand-by / 27 °C			
Class / T° K	H / 125° K				F / 105° K				H / 150° K				H / 163° K			
Phase	3 ph.				3 ph.				3 ph.				3 ph.			
Y	380V	416V	440V	480V	380V	416V	440V	480V	380V	416V	440V	480V	380V	416V	440V	480V
Δ	220V	240V			220V	240V			220V	240V			220V	240V		
YY (*)		208V	220V	240V		208V	220V	240V		208V	220V	240V		208V	220V	240V
TAL 049 B kVA	725	795	840	915	660	725	765	835	770	845	890	970	800	875	925	1005
kW	580	636	672	732	528	580	612	668	616	676	712	776	640	700	740	804
TAL 049 C kVA	815	890	940	1025	740	810	855	935	865	945	995	1085	895	980	1040	1130
kW	652	712	752	820	592	648	684	748	692	756	796	868	716	784	832	904
TAL 049 D kVA	905	990	1045	1140	825	900	950	1035	960	1050	1110	1210	1000	1090	1155	1255
kW	724	792	836	912	660	720	760	828	768	840	888	968	800	872	924	1004
TAL 049 E kVA	990	1083	1146	1250	900	985	1045	1140	1050	1150	1215	1325	1089	1192	1260	1375
kW	792	866	917	1000	720	788	836	912	840	920	972	1060	871	954	1008	1100

(*) 12-wire option

Efficiencies 400 V - 50 Hz (— P.F.: 0.8) (----- P.F.: 1)

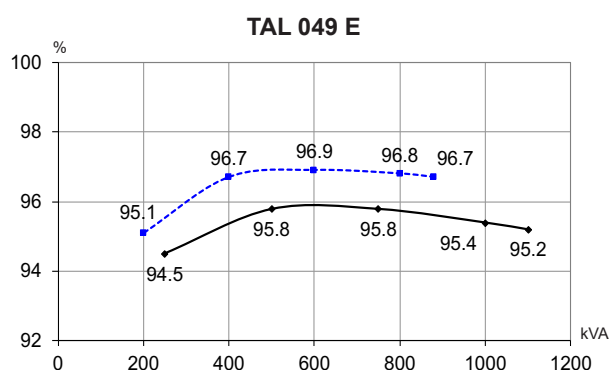
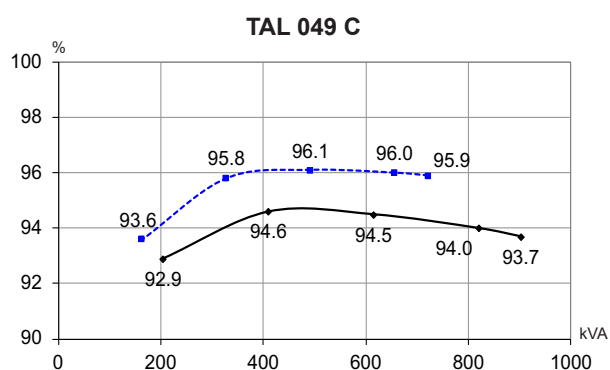
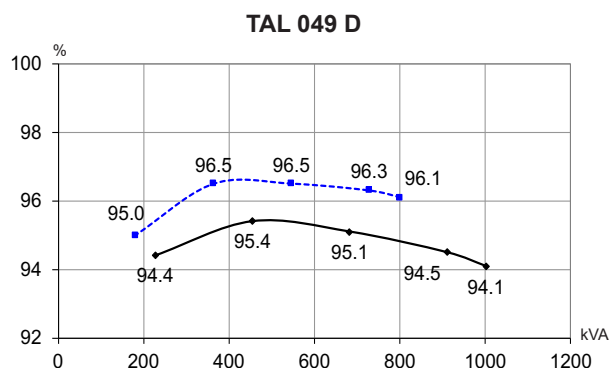
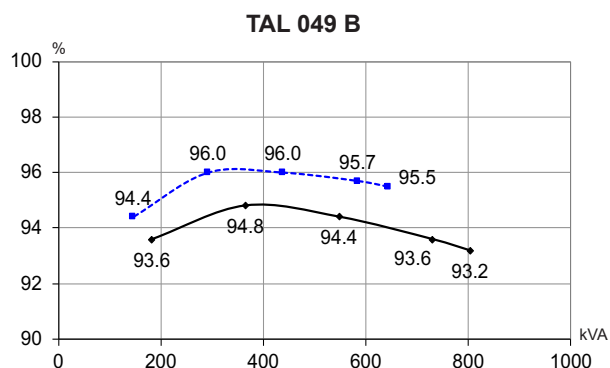

Reactances (%). Time constants (ms) - Class H / 400 V

	B	C	D	E
Kcc Short-circuit ratio	0.28	0.37	0.28	0.34
Xd Direct-axis synchronous reactance unsaturated	403	330	402	348
Xq Quadrature-axis synchronous reactance unsaturated	205	168	205	177
T'do No-load transient time constant	2028	2074	2108	2153
X'd Direct-axis transient reactance saturated	19.8	15.9	19	16.1
T'd Short-circuit transient time constant	100	100	100	100
X''d Direct-axis subtransient reactance saturated	15.9	12.7	15.2	12.9
T''d Subtransient time constant	10	10	10	10
X''q Quadrature-axis subtransient reactance saturated	18.3	14.4	16.9	14.1
Xo Zero sequence reactance	0.82	0.66	0.79	0.67
X2 Negative sequence reactance saturated	17.12	13.59	16.11	13.53
Ta Armature time constant	15	15	15	15

Other class H / 400 V data

io (A) No-load excitation current SHUNT/AREP+	0.79	1.11	0.81	0.9
ic (A) On-load excitation current SHUNT/AREP+	4.03	4.62	4.03	3.62
uc (V) On-load excitation voltage SHUNT/AREP+	45.7	52.2	45.4	40.9
ms Response time ($\Delta U = 20\%$ transient)	500	500	500	500
kVA Start ($\Delta U = 20\%$ cont. or $\Delta U = 30\%$ trans.) SHUNT*	1040	1324	1354	1753
kVA Start ($\Delta U = 20\%$ cont. or $\Delta U = 30\%$ trans.) AREP+*	1478	1897	1913	2553
% Transient ΔU (on-load 4/4) SHUNT - P.F.: 0.8 _{LAG}	19	18.7	18.4	16.2
% Transient ΔU (on-load 4/4) AREP+ - P.F.: 0.8 _{LAG}	14.5	12.3	14.1	11.3
W No-load losses	7774	10303	8474	9556
W Heat dissipation	39596	41666	42360	38187

* P.F. = 0.6

Transient voltage variation 400 V - 50 Hz

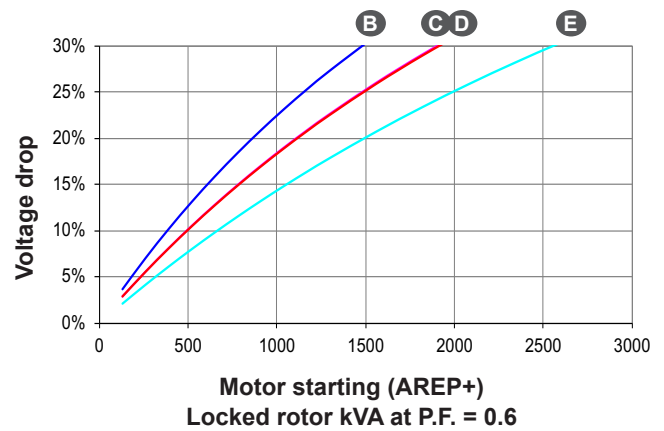
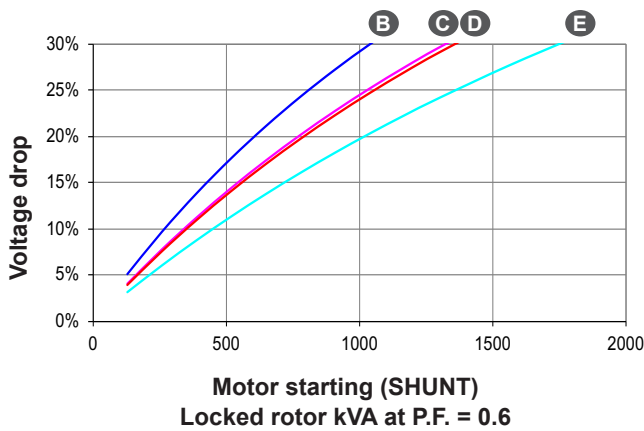
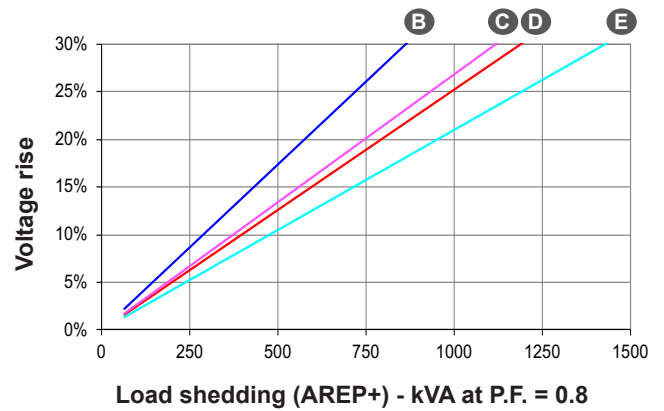
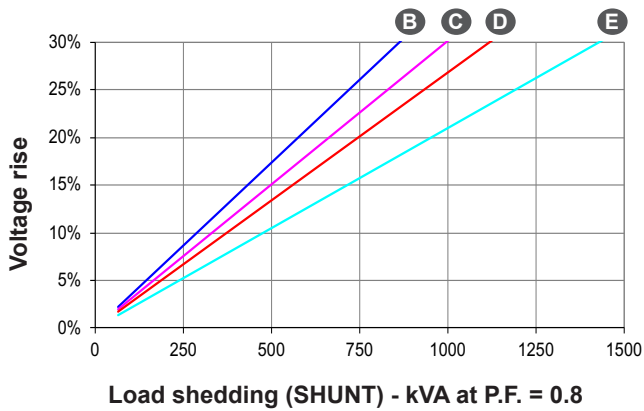
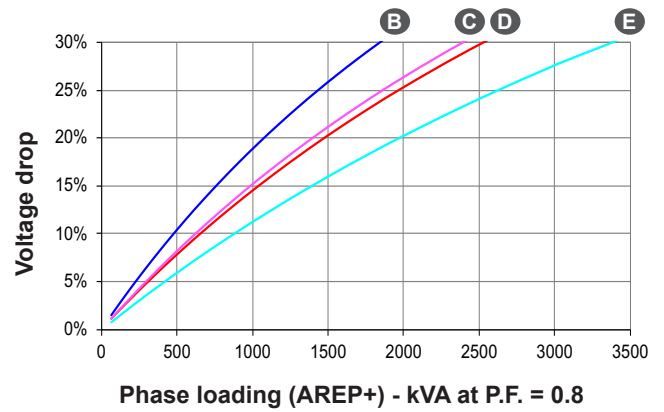
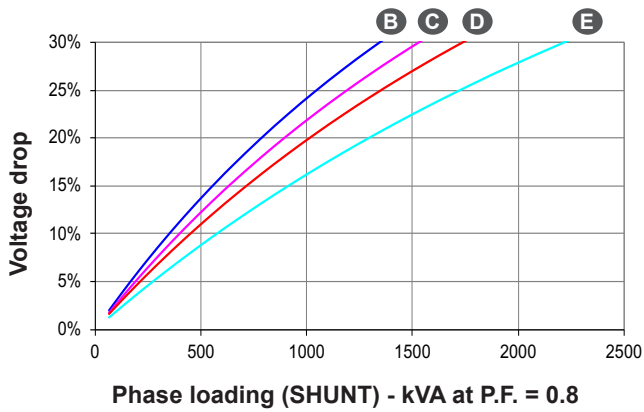

- For a starting P.F. other than 0.6, the starting kVA must be multiplied by $K = \text{Sine P.F.} / 0.8$
- For voltages other than 400V (Y), 230V (Δ) at 50 Hz, then kVA must be multiplied by $(400/U)^2$ or $(230/U)^2$.
- Transient performance of the PMG option, consult us.

Efficiencies 480 V - 60 Hz (— P.F.: 0.8) (..... P.F.: 1)

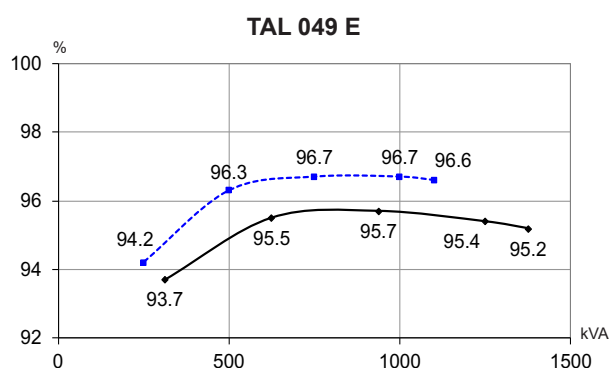
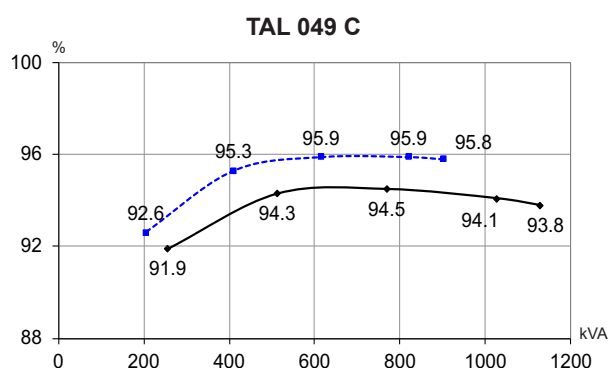
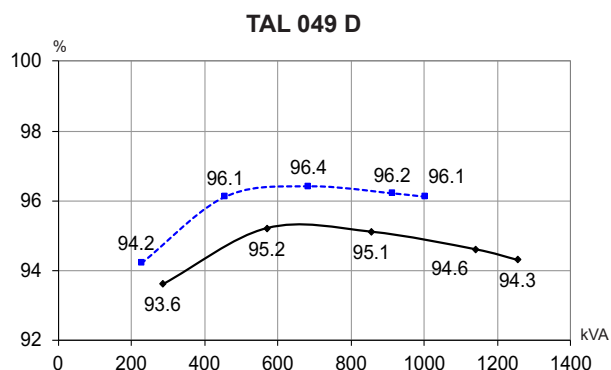
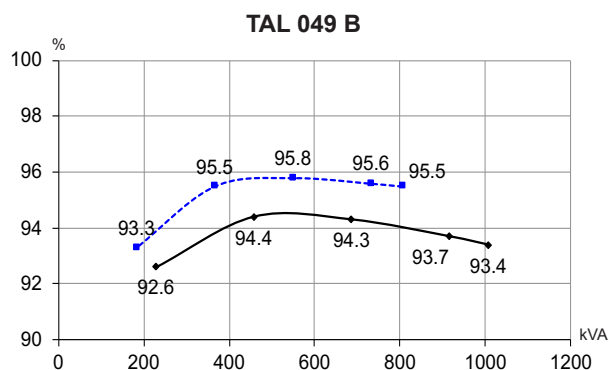

Reactances (%). Time constants (ms) - Class H / 480 V

	B	C	D	E
Kcc Short-circuit ratio	0.27	0.36	0.27	0.33
Xd Direct-axis synchronous reactance unsaturated	421	344	419	363
Xq Quadrature-axis synchronous reactance unsaturated	214	175	214	185
T'do No-load transient time constant	2028	2074	2108	2153
X'd Direct-axis transient reactance saturated	20.7	16.6	19.9	16.8
T'd Short-circuit transient time constant	100	100	100	100
X''d Direct-axis subtransient reactance saturated	16.6	13.2	15.9	13.4
T''d Subtransient time constant	10	10	10	10
X''q Quadrature-axis subtransient reactance saturated	19.1	15	17.7	14.7
Xo Zero sequence reactance	0.86	0.69	0.82	0.7
X2 Negative sequence reactance saturated	17.89	14.16	16.82	14.1
Ta Armature time constant	15	15	15	15

Other class H / 480 V data

	B	C	D	E
io (A) No-load excitation current SHUNT/AREP+	0.79	1.11	0.81	0.9
ic (A) On-load excitation current SHUNT/AREP+	4.15	4.72	4.13	3.69
uc (V) On-load excitation voltage SHUNT/AREP+	47.2	53.6	46.8	41.9
ms Response time ($\Delta U = 20\%$ transient)	500	500	500	500
kVA Start ($\Delta U = 20\%$ cont. or $\Delta U = 30\%$ trans.) SHUNT*	1247	1626	1624	2114
kVA Start ($\Delta U = 20\%$ cont. or $\Delta U = 30\%$ trans.) AREP+*	1770	2373	2307	3224
% Transient ΔU (on-load 4/4) SHUNT - P.F.: 0.8 _{LAG}	19.6	19.2	19	16.7
% Transient ΔU (on-load 4/4) AREP+ - P.F.: 0.8 _{LAG}	15	12.6	14.5	11.7
W No-load losses	12224	15725	13141	14640
W Heat dissipation	48486	51103	51860	47175

* P.F. = 0.6

Transient voltage variation 480 V - 60 Hz

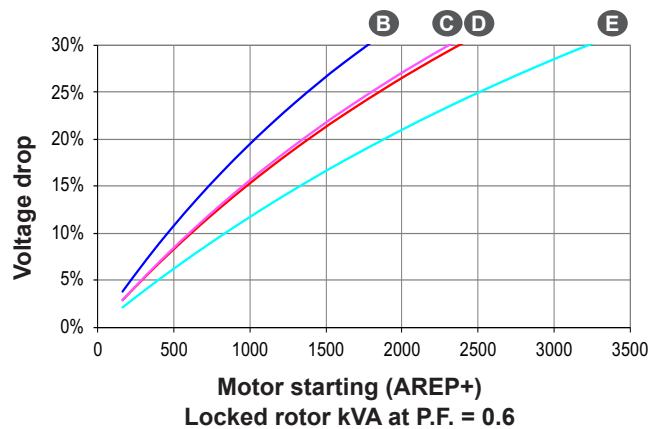
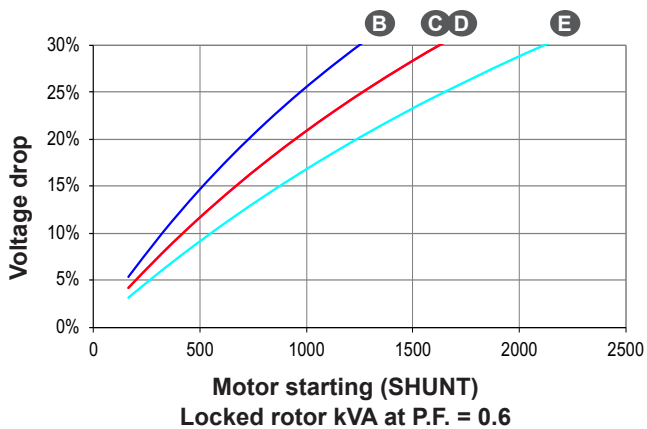
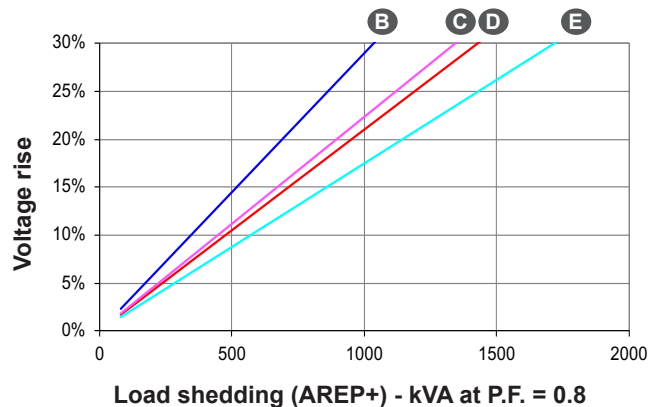
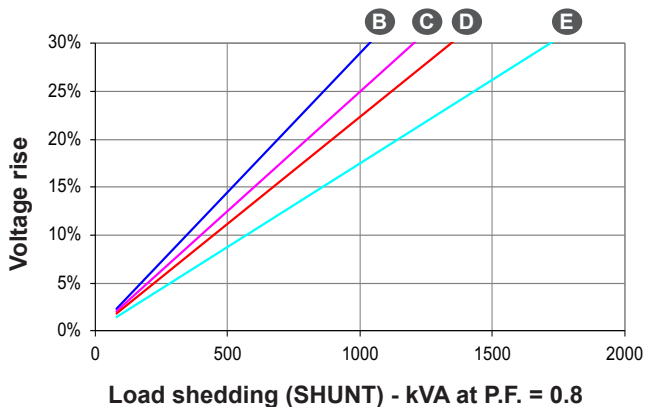
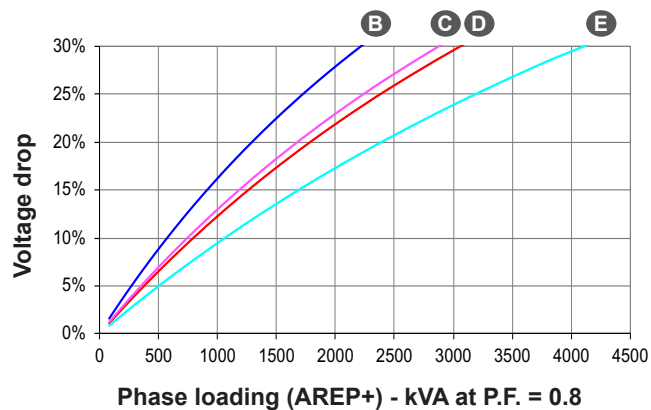
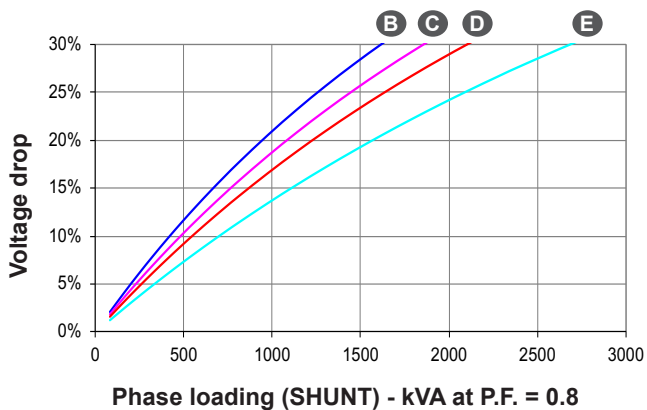

- For a starting P.F. other than 0.6, the starting kVA must be multiplied by $K = \text{Sine P.F.} / 0.8$
- For voltages other than 480V (Y), 277V (Δ), 240V (YY) at 60 Hz, then kVA must be multiplied by $(480/U)^2$ or $(277/U)^2$ or $(240/U)^2$.
- Transient performance of the PMG option, consult us.

3-phase short-circuit curves at no load and rated speed (star connection Y)

TAL 049 B

Symmetrical —
Asymmetrical - - -

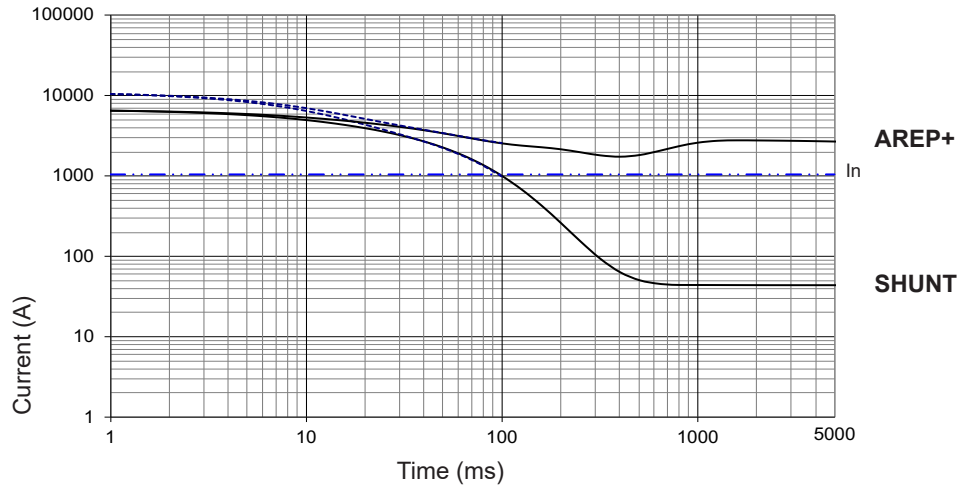

TAL 049 C

Symmetrical —
Asymmetrical - - -

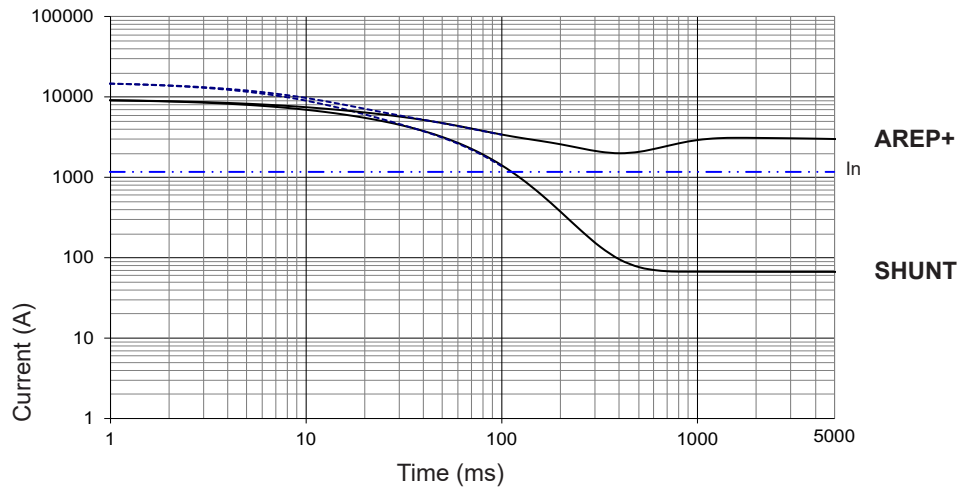

Influence due to connection

For (Δ) connection, use the following multiplication factor:
- Current value x 1.732.

3-phase short-circuit curves at no load and rated speed (star connection Y)

TAL 049 D

Symmetrical —
Asymmetrical - - -

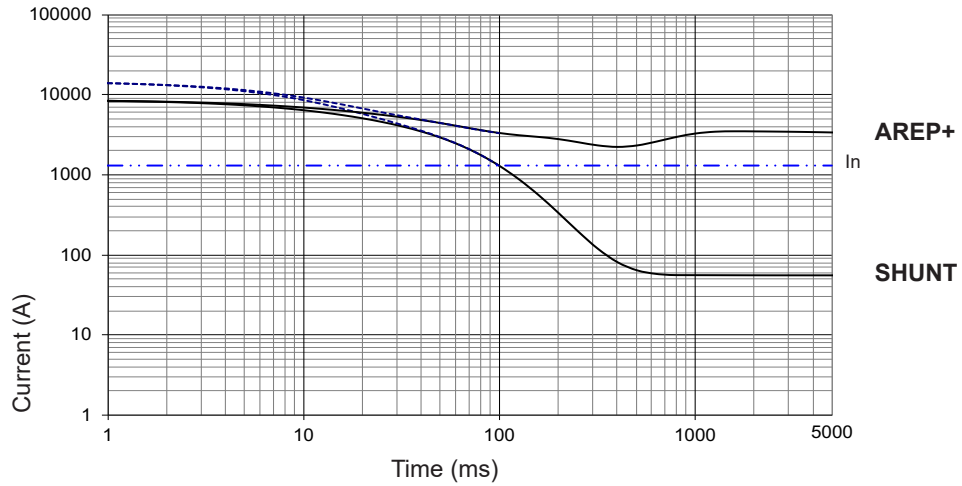

TAL 049 E

Symmetrical —
Asymmetrical - - -

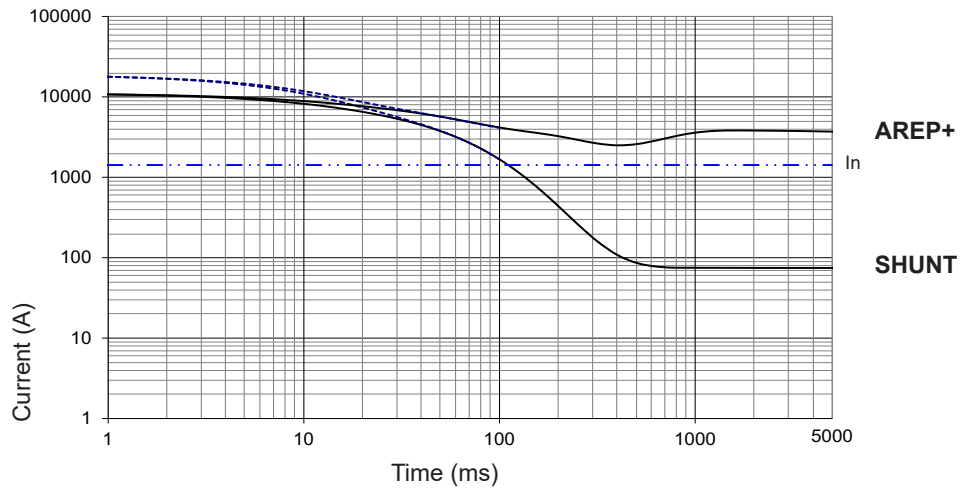

Influence due to short-circuit

Curves are based on a three-phase short-circuit.
For other types of short-circuit,
use the following multiplication factors.

	3 - phase	2 - phase L / L	1 - phase L / N
Instantaneous (max.)	1	0.87	1.3
Continuous	1	1.5	2.2
Maximum duration (AREP+/PMG)		1.5	

Single-bearing dimensions

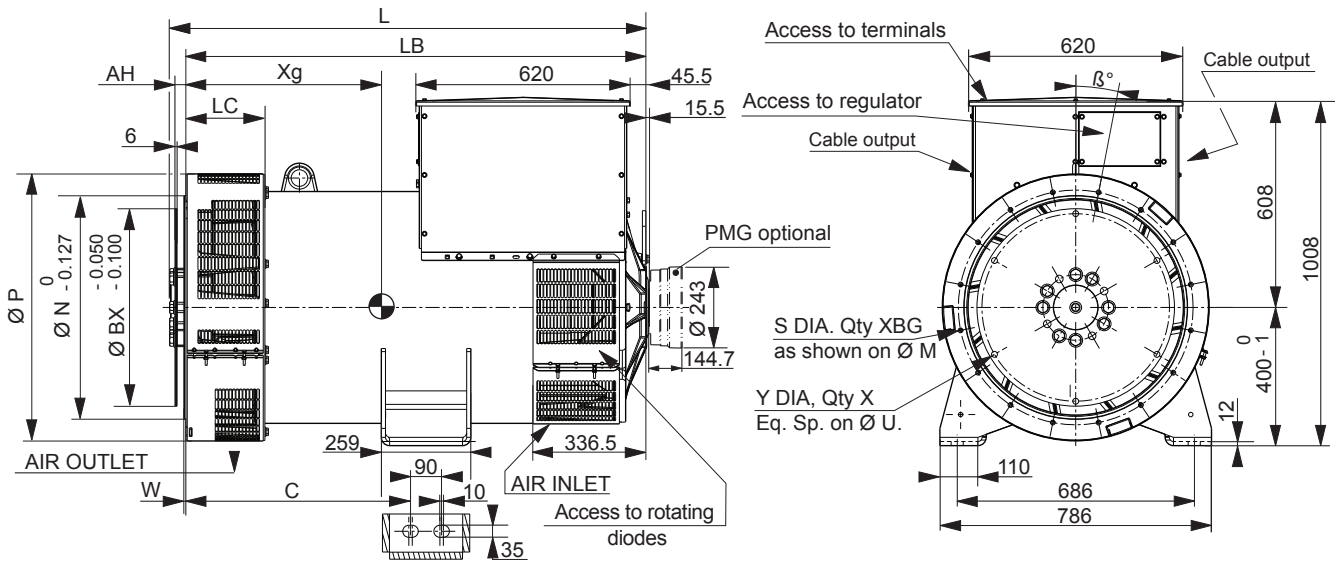

Dimensions (mm) and weight						Coupling		
Type	L without PMG maxi*	LB	C	Xg	Weight (kg)	Flex plate	14	18
TAL 049 B	1372	1331	650	629	1574	Flange S.A.E 1	X	
TAL 049 C	1372	1331	650	636	1635	Flange S.A.E 1/2	X	
TAL 049 D	1462	1421	650	673	1788	Flange S.A.E 0	X	X
TAL 049 E	1462	1421	650	681	1837	Flange S.A.E 00		X

* L maxi = LB + AH maxi + 15.5

Flange (mm)								Flex plate (mm)					
S.A.E.	P	N	M	LC	XBG	W	β°	S.A.E.	BX	U	X	Y	AH
1	773	511.175	530.225	228.5	12	6	15°	14	466.7	438.15	8	14	25.4
1/2	773	584.2	619.125	228.5	12	6	15°	18	571.5	542.92	6	17	15.7
0	773	647.7	679.45	228.5	16	6	11° 15'						
00	883	787.4	850.9	245	16	7	11° 15'						

Torsional analysis data

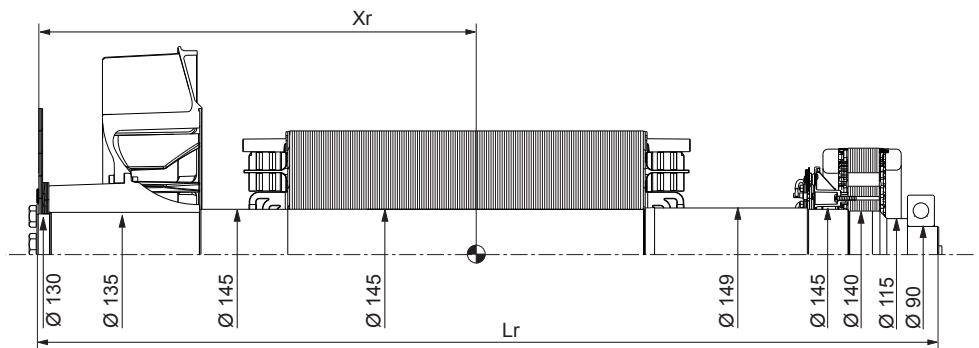

Centre of gravity: Xr (mm), Rotor length: Lr (mm), Weight: M (kg), Moment of inertia: J (kgm²): (4J = MD²)									
Flex plate	S.A.E. 14				S.A.E. 18				
	Type	Xr	Lr	M	J	Xr	Lr	M	J
TAL 049 B		626	1345	602	9.61	614	1345	604	9.87
TAL 049 C		634	1345	628	10.16	622	1345	630	10.42
TAL 049 D		671	1435	684	11.12	659	1435	686	11.38
TAL 049 E		681	1435	701	11.48	669	1435	703	11.74

NOTE : Dimensions are for information only and may be subject to modifications. The torsional analysis of the transmission is imperative. All values are available upon request.

LEROY-SOMER[™]

www.leroy-somer.com/epg

[Linkedin.com/company/leroy-somer](https://www.linkedin.com/company/leroy-somer)
[Twitter.com/Leroy_Somer_en](https://twitter.com/Leroy_Somer_en)
[Facebook.com/LeroySomer.Nidec.en](https://www.facebook.com/LeroySomer.Nidec.en)
[YouTube.com/LeroySomerOfficiel](https://www.youtube.com/LeroySomerOfficiel)



Nidec
All for dreams

© Nidec 2020. The information contained in this brochure is for guidance only and does not form part of any contract. The accuracy cannot be guaranteed as Nidec have an ongoing process of development and reserve the right to change the specification of their products without notice.

Moteurs Leroy-Somer SAS. Siège : Bd Marcellin Leroy, CS 10015, 16915 Angoulême Cedex 9, France.
Capital social : 38 679 664 €, RCS Angoulême 338 567 258.