

ALTERNATOR DATASHEET

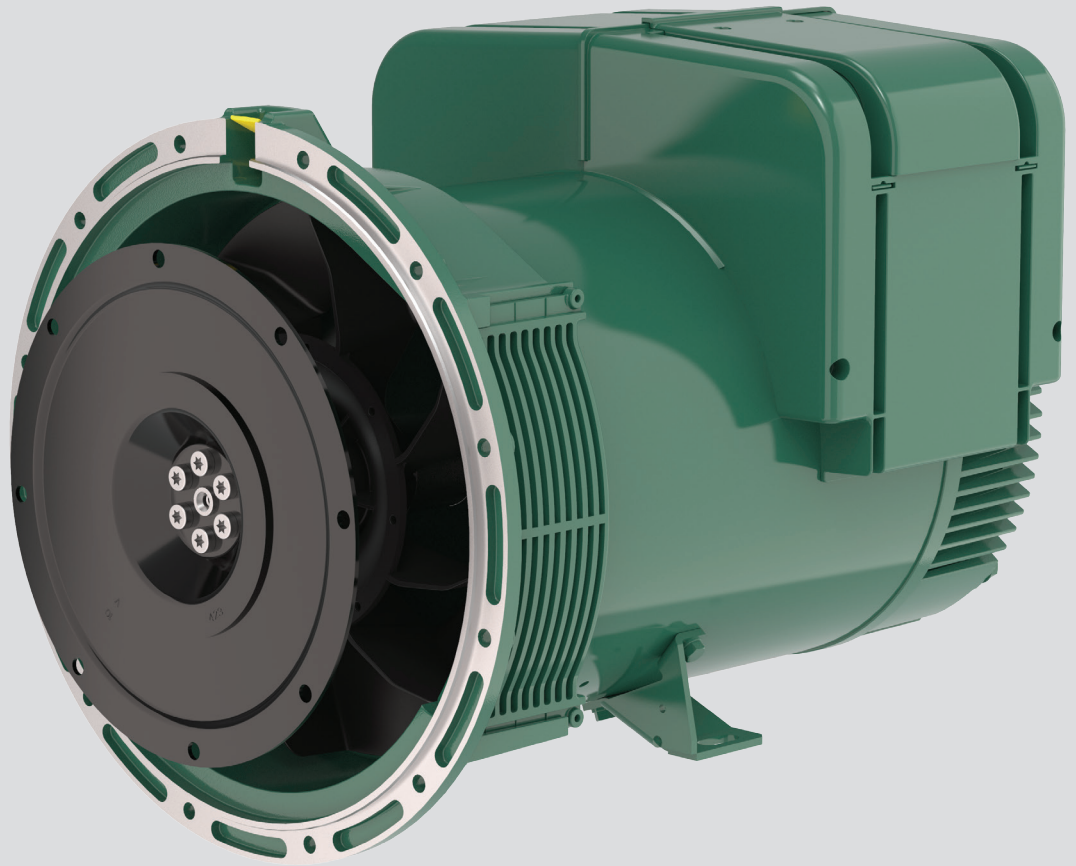



LSA 42.3

Low Voltage Alternator - 4 pole

25 to 60 kVA - 50 Hz / 31.5 to 75 kVA - 60 Hz
Electrical and mechanical data

LEROY-SOMER[™]

Nidec
All for dreams

The best of performance

Nidec Leroy-Somer LSA 42.3 alternator has been designed to offer you the best power generation performances. With its meticulous design and optimized architecture, the LSA 42.3 strikes the perfect balance between compactness, reliability, performance and longevity.

Whatever your application, the LSA 42.3 will meet your needs and will adapt to all situations.

Standards

Nidec Leroy-Somer LSA 42.3 alternator meets all key international standards and regulations, including IEC 60034, NEMA MG 1.32-33, ISO 8528-3, CSA C22.2 n°100-14 and UL 1446 (UL 1004 on request). Also compliant with IEC 61000-6-2, IEC 61000-6-3, IEC 61000-6-4, VDE 0875G, VDE 0875N and EN 55011, group 1 class A for European zone.

Nidec Leroy-Somer LSA 42.3 alternator can be integrated in EC marked generator set, and bears EC and CMIM markings. It is designed, manufactured and marketed in an ISO 9001 and ISO 14001 quality assurance environment.

Electrical characteristics and performances

- Class H insulation
- 2/3 pitch winding, standard 12-wire (6) reconnectable
- Voltage range:
 - 50 Hz: 220V - 240V and 380V - 415V (440V)
 - 60 Hz: 208V - 240V and 380V - 480V
- High efficiency and motor starting capacity
- Other voltages are possible with optional adapted windings:
 - 50 Hz: 440V (no. 7), 500V (no. 9), 550V (no. 22), 600V (no. 23), 690V (no. 10)
 - 60 Hz: 380V and 416V (no. 8), 600V (no. 9), 690V (no. 22)

Excitation and regulation system

Excitation system				Regulation options		
AVR	SHUNT	AREP (option)	PMG (option)	C.T. Current transformer for paralleling	Mains paralleling	Remote voltage potentiometer
R220	Standard					
D350	Option	Standard	Standard	√*		√
D550**	Option	Option	Option	√*	√	√

*: only with AREP or PMG

** : steel terminal box mounting only

3-phase sensing is included as a standard with digital regulators.

Protection system and options

- The LSA 42.3 is IP 23
- Complete winding protection for clean environments with relative humidity \leq 95%, including indoor marine environments
- Options:
 - Filters on air inlet: derating 5%
 - Filters on air inlet and air outlet (IP 44): derating 10%
 - Reinforced winding protection for harsh environments and relative humidity greater than 95%
 - Space heater
 - Thermal protection for stator windings
 - Shaft height: H = 225 mm (to be specified when ordering)

Mechanical construction

- Compact rigid assembly to better withstand generator vibrations
- Steel frame and terminal box
- Aluminum flanges and shields
- Two-bearing and single-bearing versions designed to be suitable for commercially-available heat engines
- Half-key balancing two-bearing
- Greased for life bearings (20 000h)
- Direction of rotation: clockwise and anti-clockwise (without derating)

Terminal box design

- Easy access to the voltage regulator (lid) and to the connections
- 8-way terminal block for reconnecting the voltage
- Predrilled holes for cable gland



LSA 42.3 - 25 to 60 kVA - 50 Hz / 31.5 to 75 kVA - 60 Hz

General characteristics

Insulation class	H	Excitation system	SHUNT	AREP / PMG
Winding pitch	2/3 (wind. 6)	AVR type	R220	D350
Number of wires	12	Voltage regulation (*)	± 0.5%	± 0.25%
Protection	IP 23	Short-circuit current	-	300% (3 IN): 10 s
Altitude	≤ 1000 m	Total Harmonic Distortion THD (**) in no-load	< 2%	
Overspeed	2250 R.P.M.	Total Harmonic Distortion THD (**) on linear load :	< 4%	
Air flow	0.10 m ³ /s (50 Hz) - 0.13 m ³ /s (60 Hz)	Waveform: NEMA = TIF (**)	< 50	

(*) Steady state (**) Total harmonic distortion between phases, no-load or on-load (non-distorting)

Ratings 50 Hz - 1500 R.P.M.

kVA / kW - P.F. = 0.8																				
Duty/T°C	Continuous duty/40°C					Continuous duty/40°C					Stand-by/40°C		Stand-by/27°C							
Class/T°K	H/125°K					F/105°K					H/150°K		H/163°K							
Phase	3 ph.		1 ph.			3 ph.		1 ph.			3 ph.		1 ph.							
Y	380V	400V	415V	440V	ΔΔ	380V	400V	415V	440V	ΔΔ	380V	400V	415V	440V	ΔΔ	380V	400V	415V	440V	ΔΔ
Δ	220V	230V	240V		230V	220V	230V	240V		230V	220V	230V	240V		230V	220V	230V	240V		230V
YY		200V		220V			200V		220V			200V		220V			200V		220V	
LSA 42.3 VS1 kVA	25	25	25	24.5	15	23	23	23	22.5	13.5	26.5	26.5	26.5	26	16	27.5	27.5	27.5	27	16.5
kW	20	20	20	19.5	12	18.5	18.5	18.5	18	11	21	21	21	21	13	22	22	22	21.5	13
LSA 42.3 VS2 kVA	27	27	27	26	16	24.5	24.5	24.5	23.5	14.5	28.5	28.5	28.5	27.5	17	30	30	30	28.5	17.5
kW	21.5	21.5	21.5	21	13	19.5	19.5	19.5	19	11.5	23	23	23	22	13.5	24	24	24	23	14
LSA 42.3 VS3 kVA	32	32	32	30	19	29	29	29	27.5	17.5	34	34	34	32	20	35	35	35	33	21
kW	25.5	25.5	25.5	24	15	23	23	23	22	14	27	27	27	25.5	16	28	28	28	26.5	17
LSA 42.3 S4 kVA	35	35	35	30.5	22	32	32	32	28	20	37	37	37	32.5	23.5	38.5	38.5	38.5	33.5	24
kW	28	28	28	24.5	17.5	25.5	25.5	25.5	22.5	16	29.5	29.5	29.5	26	19	31	31	31	27	19
LSA 42.3 S5 kVA	40	40	40	35	25	36.5	36.5	36.5	32	23	42.5	42.5	42.5	37	26.5	45	45	45	38.5	27.5
kW	32	32	32	28	20	29	29	29	25.5	18.5	34	34	34	29.5	21	36	36	36	31	22
LSA 42.3 M7 kVA	45	45	45	39	27	41	41	41	35.5	24.5	48	48	48	41.5	28.5	50	50	50	43	29.5
kW	36	36	36	31	21.5	33	33	33	28.5	19.5	38.5	38.5	38.5	33	23	40	40	40	34.5	23.5
LSA 42.3 M8 kVA	50	50	50	43	30	45.5	45.5	45.5	39	27.5	53	53	53	45.5	32	55	55	55	47.5	33
kW	40	40	40	34.5	24	36.5	36.5	36.5	31	22	42	42	42	36.5	25.5	44	44	44	38	26.5
LSA 42.3 L9 kVA	60	60	60	52	36	55	55	55	47.5	33	64	64	64	55	38	66	66	66	57	39.5
kW	48	48	48	42	29	44	44	44	38	26.5	51	51	51	44	30.5	53	53	53	46	31.5

Ratings 60 Hz - 1800 R.P.M.

kVA / kW - P.F. = 0.8																				
Duty/T°C	Continuous duty/40°C					Continuous duty/40°C					Stand-by/40°C		Stand-by/27°C							
Class/T°K	H/125°K					F/105°K					H/150°K		H/163°K							
Phase	3 ph.		1 ph.			3 ph.		1 ph.			3 ph.		1 ph.							
Y	380V	416V	440V	480V	ΔΔ	380V	416V	440V	480V	ΔΔ	380V	416V	440V	480V	ΔΔ	380V	416V	440V	480V	ΔΔ
Δ	220V	240V			240V	220V	240V			240V	220V	240V			240V	220V	240V			240V
YY		208V	220V	240V			208V	220V	240V			208V	220V	240V			208V	220V	240V	
LSA 42.3 VS1 kVA	29	31.5	31.5	31.5	18.9	26.5	28.5	28.5	28.5	17	30.5	33.5	33.5	33.5	20	32	34.5	34.5	34.5	20.8
kW	23	25	25	25	15	21	23	23	23	13.5	24.5	27	27	27	16	25.5	27.5	27.5	27.5	16.5
LSA 42.3 VS2 kVA	30	32	34	34	19.2	27.5	29	31	31	17.5	32	34	36	36	20.5	33	35	37.5	37.5	21.1
kW	24	25.5	27	27	15.5	22	23	25	25	14	25.5	27	29	29	16.5	26.5	28	30	30	17
LSA 42.3 VS3 kVA	34.5	38	40	40	23	31.5	34.5	36.5	36.5	21	36.5	40.5	42.5	42.5	24.5	38	42	44	44	25.5
kW	27.5	30.5	32	32	18.5	25	27.5	29	29	17	29	32.5	34	34	19.5	30.5	33.5	35	35	20.5
LSA 42.3 S4 kVA	37.5	40.5	43	44	24	34	37	39	40	22	40	43	45.5	46.5	25.5	41.5	44.5	47.5	48.5	26.5
kW	30	32.5	34.5	35	19	27	29.5	31	32	17.5	32	34.5	36.5	37	20.5	33	35.5	38	39	21
LSA 42.3 S5 kVA	42	46	49	50	27.5	38	42	44.5	45.5	25	44.5	49	52	53	29	46	51	54	55	30.5
kW	33.5	37	39	40	22	30.5	33.5	35.5	36.5	20	35.5	39	42	42	23	37	41	43	44	24.5
LSA 42.3 M7 kVA	46	50	53.5	56.5	30	42	45.5	48.5	51	27.5	49	53	57	60	32	51	55	59	62.5	33
kW	37	40	43	45	24	33.5	36.5	39	41	22	39	42	46	48	25.5	41	44	47	50	26.5
LSA 42.3 M8 kVA	51.5	56.5	59.5	62.5	34	47	51	54	57	31	55	60	63	66.5	36	57	62.5	65.5	69	37.5
kW	41	45	48	50	27	37.5	41	43	46	25	44	48	50	53	29	46	50	52	55	30
LSA 42.3 L9 kVA	59	65	69	75	39	54	59	63	68	35.5	63	69	73	80	41.5	65	72	76	82.5	43
kW	47	52	55	60	31	43	47	50	54	28.5	50	55	58	64	33	52	58	61	66	34.5

Efficiencies 400 V - 50 Hz (— P.F.: 0.8) (--- P.F.: 1)

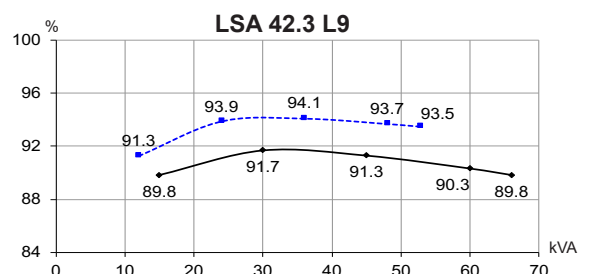
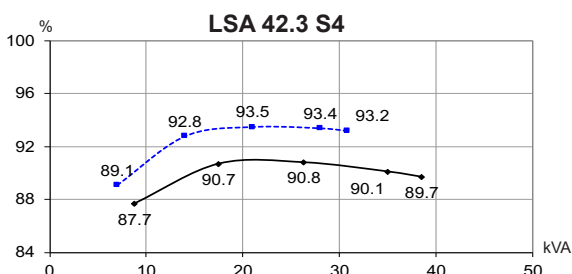
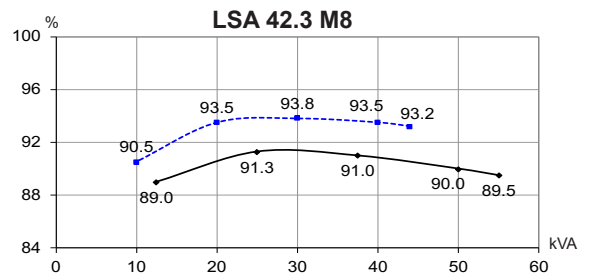
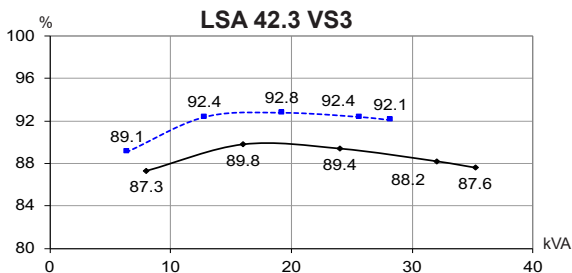
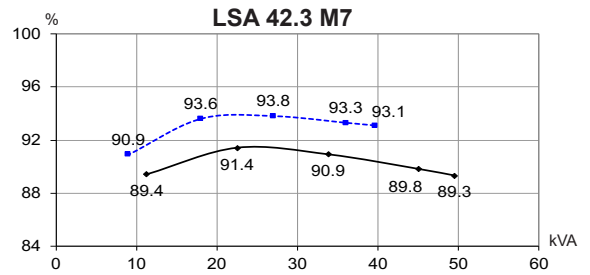
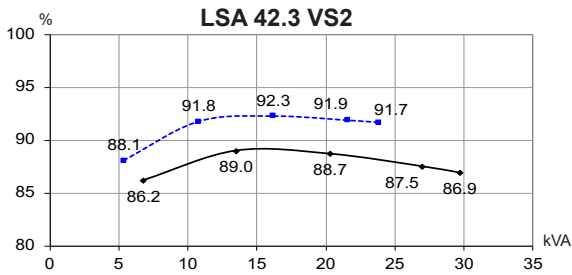
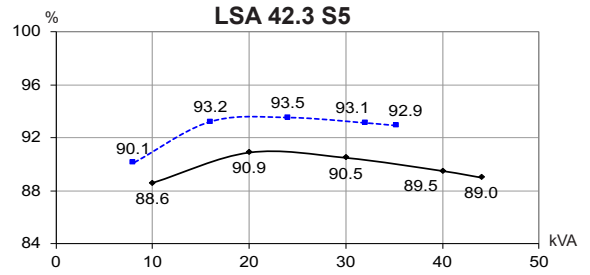
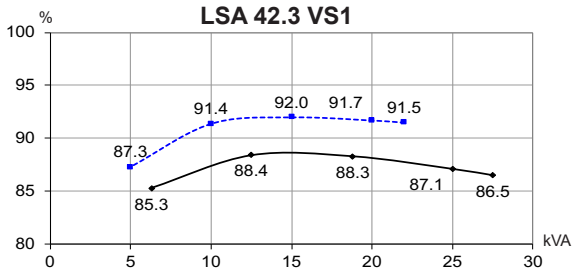

Reactances (%). Time constants (ms) - Class H / 400 V

	VS1	VS2	VS3	S4	S5	M7	M8	L9
Kcc Short-circuit ratio	0.54	0.51	0.48	0.53	0.46	0.43	0.47	0.44
Xd Direct-axis synchronous reactance unsaturated	240	249	261	229	262	275	264	283
Xq Quadrature-axis synchronous reactance unsaturated	122	127	133	117	133	140	134	144
T'do No-load transient time constant	733	759	803	880	880	914	931	962
X'd Direct-axis transient reactance saturated	16.3	16.4	16.2	13	14.8	15	14.1	14.7
T'd Short-circuit transient time constant	50	50	50	50	50	50	50	50
X''d Direct-axis subtransient reactance saturated	8.1	8.2	8.1	6.5	7.4	7.5	7.0	7.3
T''d Subtransient time constant	5	5	5	5	5	5	5	5
X''q Quadrature-axis subtransient reactance saturated	11.5	11.6	11.5	9.2	10.6	10.7	10.1	10.5
Xo Zero sequence reactance	0.68	0.68	0.67	0.54	0.62	0.62	0.59	0.61
X2 Negative sequence reactance saturated	9.88	9.91	9.82	7.89	9.02	9.12	8.61	8.93
Ta Armature time constant	8	8	8	8	8	8	8	8

Other class H/400 V data

io (A) No-load excitation current (SHUNT/AREP)	0.55/0.85	0.52/0.8	0.51/0.79	0.49/0.75	0.49/0.75	0.46/0.71	0.5/0.78	0.5/0.77
ic (A) On-load excitation current (SHUNT/AREP)	1.77/2.72	1.75/2.68	1.8/2.76	1.55/2.38	1.76/2.7	1.77/2.71	1.9/2.91	2.07/3.18
uc (V) On-load excitation voltage (SHUNT/AREP)	30.2/19.3	29.8/19	30.4/19.5	26.2/16.8	29.4/18.8	29.4/18.8	31.1/19.9	33.3/21.3
ms Response time ($\Delta U = 20\%$ transient)	500	500	500	500	500	500	500	500
kVA Start ($\Delta U = 20\%$ cont. or ($\Delta U = 30\%$ trans.) SHUNT	53	57	68	93	93	104	122	137
kVA Start ($\Delta U = 20\%$ cont. or ($\Delta U = 30\%$ trans.) AREP	64	68	82	112	111	124	138	154
% Transient ΔU (on-load 4/4) SHUNT - P.F.: 0.8 _{LAG}	16.3	16.3	16.2	14.3	15.4	15.5	15	15.3
% Transient ΔU (on-load 4/4) AREP - P.F.: 0.8 _{LAG}	14.7	14.7	14.6	13	14	14	13.6	13.9
W No-load losses	719	713	762	861	861	879	1029	1120
W Heat dissipation	2938	3058	3414	3072	3736	4050	4438	5134

Transient voltage variation 400V - 50 Hz

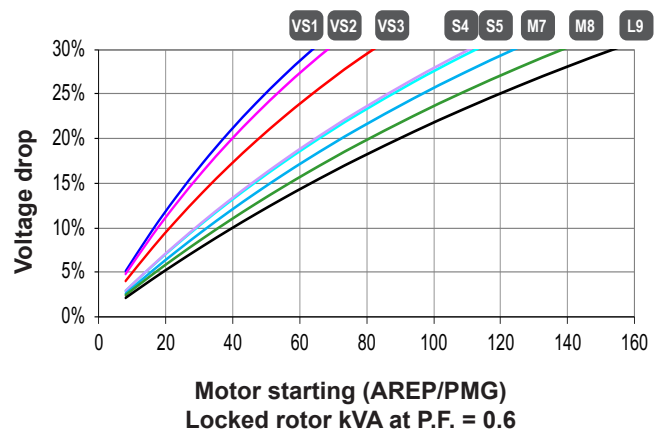
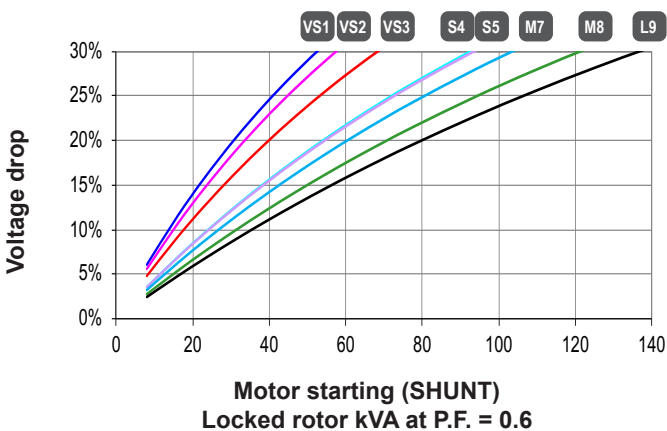
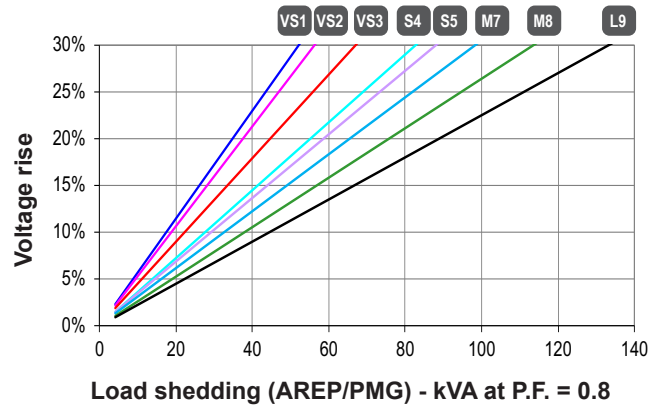
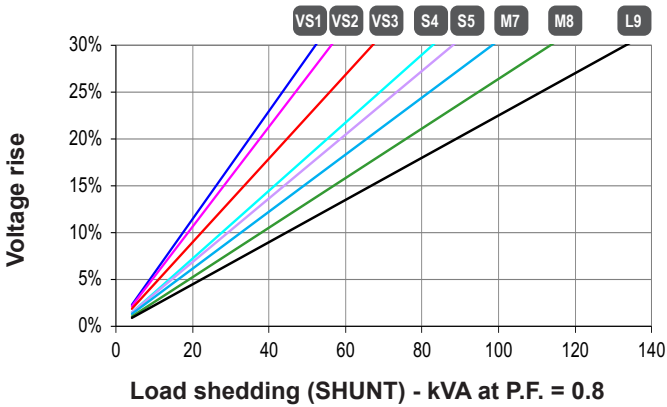
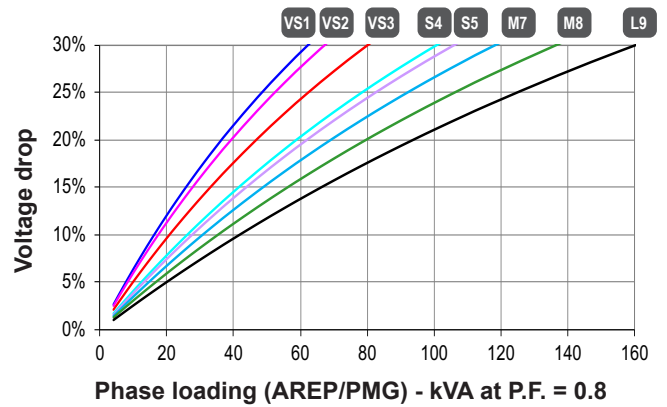
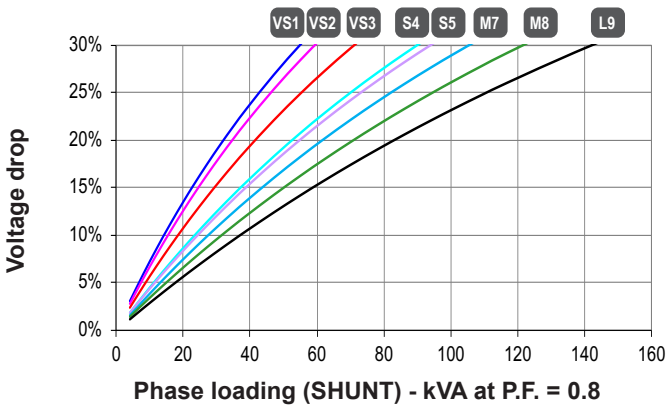

1) For a starting P.F. other than 0.6, the starting kVA must be multiplied by $K = \text{Sine P.F.} / 0.6$
 2) For voltages other than 400V (Y), 230V (Δ) at 50 Hz, then kVA must be multiplied by $(400/U)^2$ or $(230/U)^2$.

Efficiencies 480 V - 60 Hz (— P.F.: 0.8) (--- P.F.: 1)

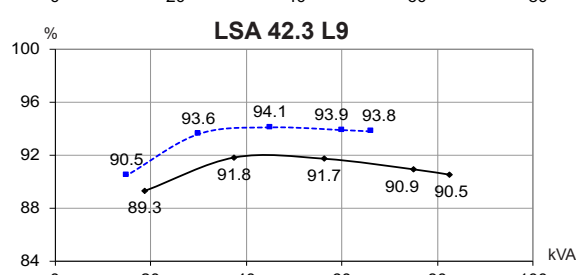
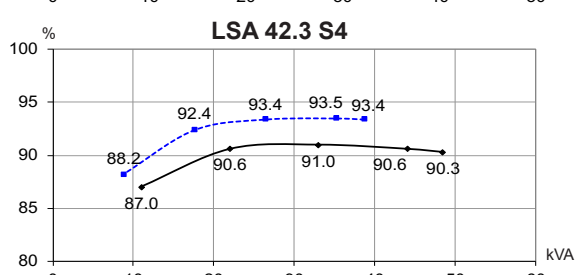
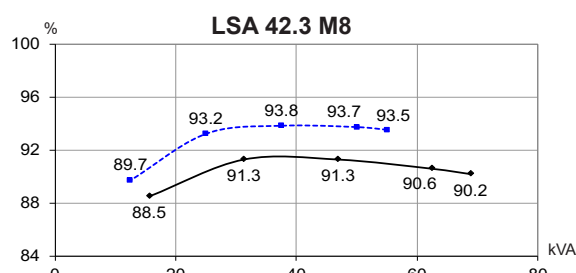
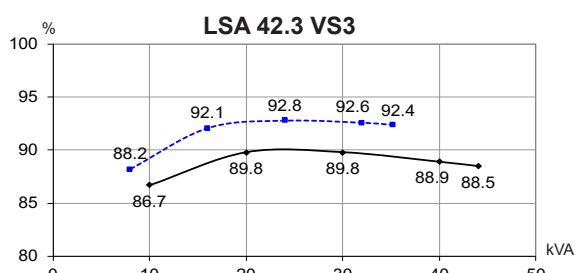
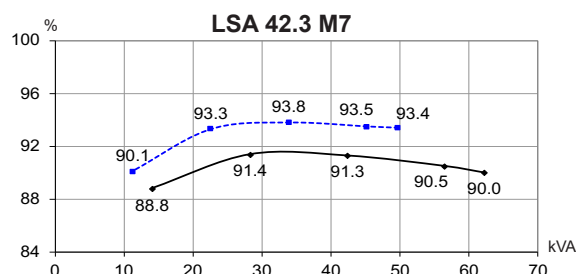
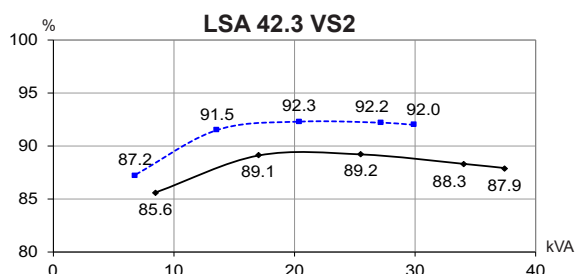
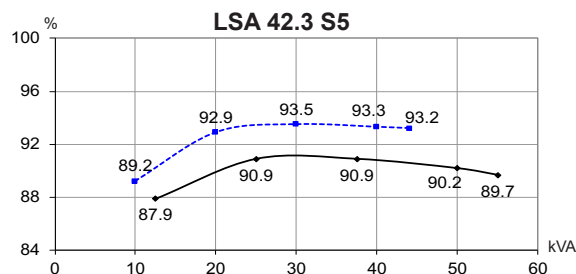
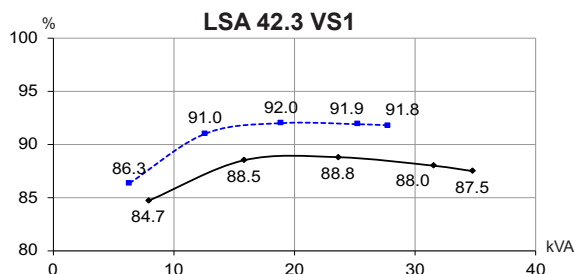

Reactances (%). Time constants (ms) - Class H / 480 V

	VS1	VS2	VS3	S4	S5	M7	M8	L9
Kcc Short-circuit ratio	0.52	0.48	0.46	0.51	0.44	0.41	0.45	0.42
Xd Direct-axis synchronous reactance unsaturated	252	261	272	240	273	287	275	294
Xq Quadrature-axis synchronous reactance unsaturated	128	133	138	122	139	146	140	150
X'do No-load transient time constant	733	759	803	880	880	914	931	962
X'd Direct-axis transient reactance saturated	17.2	17.2	16.9	13.6	15.5	15.7	14.7	15.3
T'd Short-circuit transient time constant	50	50	50	50	50	50	50	50
X''d Direct-axis subtransient reactance saturated	8.6	8.6	8.4	6.8	7.7	7.8	7.3	7.6
T''d Subtransient time constant	5	5	5	5	5	5	5	5
X''q Quadrature-axis subtransient reactance saturated	12.1	12.1	12	9.7	11	11.2	10.5	10.9
Xo Zero sequence reactance	0.71	0.71	0.7	0.56	0.64	0.65	0.61	0.63
X2 Negative sequence reactance saturated	10.37	10.4	10.24	8.27	9.39	9.55	8.97	9.3
Ta Armature time constant	8	8	8	8	8	8	8	8

Other class H/480 V data

io (A) No-load excitation current (SHUNT/AREP)	0.55/0.85	0.52/0.8	0.51/0.79	0.49/0.75	0.49/0.75	0.46/0.71	0.5/0.77	0.5/0.77
ic (A) On-load excitation current (SHUNT/AREP)	1.79/2.74	1.76/2.71	1.8/2.76	1.56/2.39	1.75/2.69	1.77/2.71	1.87/2.87	2.02/3.1
uc (V) On-load excitation voltage (SHUNT/AREP)	30.8/19.7	30.3/19.4	30.8/19.7	26.7/17.1	29.8/19	29.8/19.1	31.3/20	33.3/21.3
ms Response time ($\Delta U = 20\%$ transient)	500	500	500	500	500	500	500	500
kVA Start ($\Delta U = 20\%$ cont. or ($\Delta U = 30\%$ trans.) SHUNT	63	68	82	112	112	125	147	170
kVA Start ($\Delta U = 20\%$ cont. or ($\Delta U = 30\%$ trans.) AREP	76	82	99	135	134	150	177	202
% Transient ΔU (on-load 4/4) SHUNT - P.F.: 0.8 _{LAG}	16.8	16.8	16.6	14.7	15.8	15.9	15.4	15.7
% Transient ΔU (on-load 4/4) AREP - P.F.: 0.8 _{LAG}	15.1	15.1	15	13.3	14.3	14.4	13.9	14.2
W No-load losses	1021	1016	1087	1229	1229	1258	1462	1590
W Heat dissipation	3431	3568	3954	3640	4343	4737	5160	5960

Transient voltage variation 480V - 60 Hz

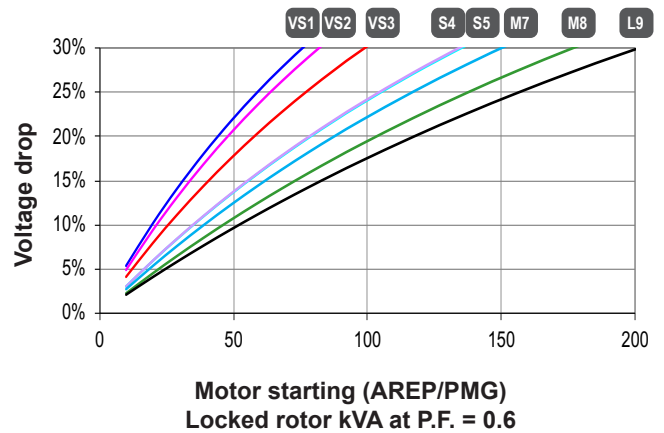
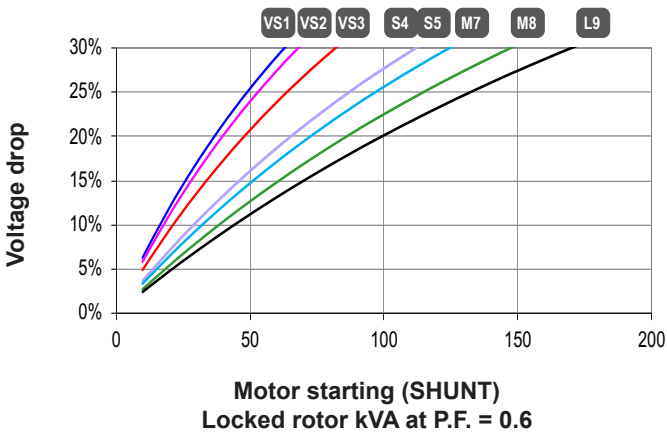
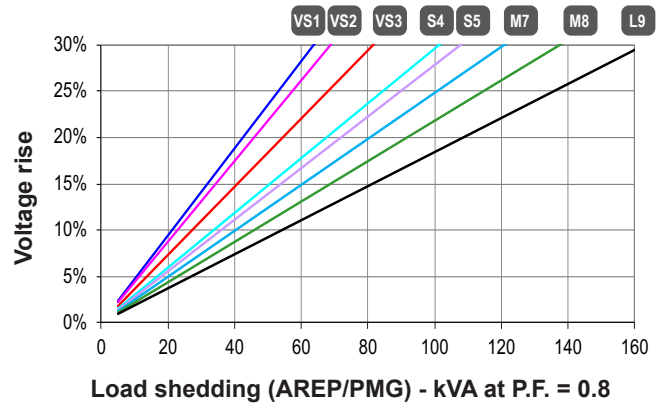
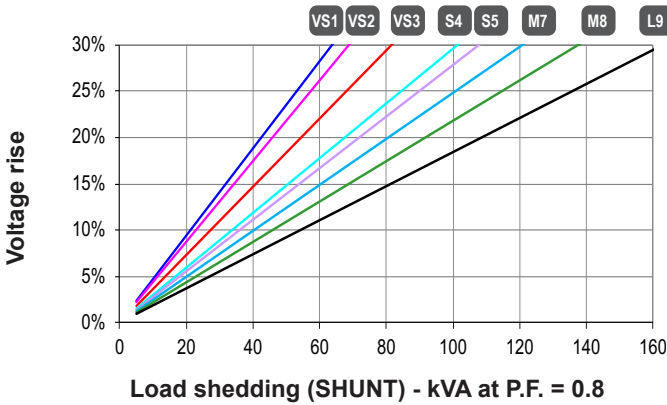
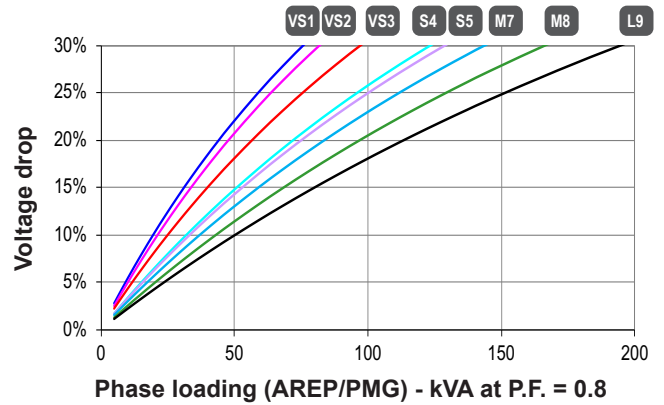
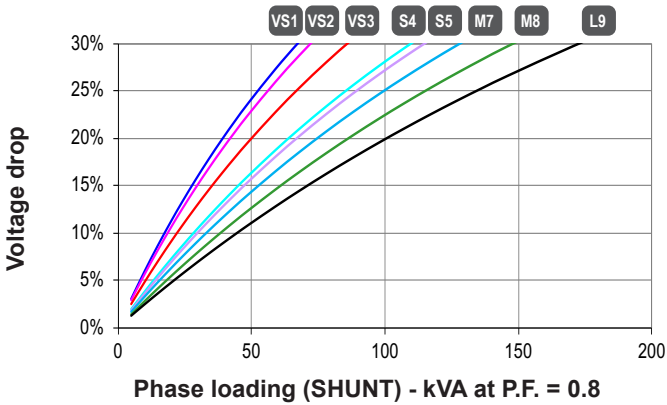

1) For a starting P.F. other than 0.6, the starting kVA must be multiplied by $K = \text{Sine P.F.} / 0.6$
 2) For voltages other than 480V (Y), 277V (Δ), 240V (YY) at 60 Hz, then kVA must be multiplied by $(480/U)^2$ or $(277/U)^2$ or $(240/U)^2$.

3-phase short-circuit curves at no load and rated speed (star connection Y)

LSA 42.3 VS1

Symmetrical —
Asymmetrical - - -

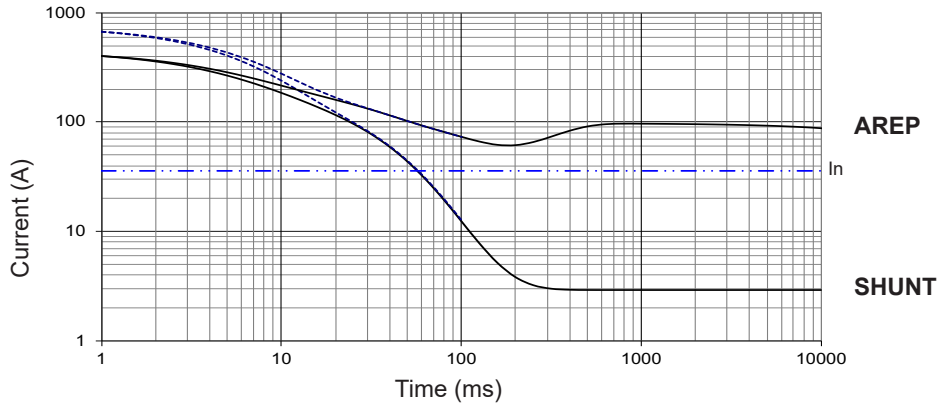

LSA 42.3 VS2

Symmetrical —
Asymmetrical - - -

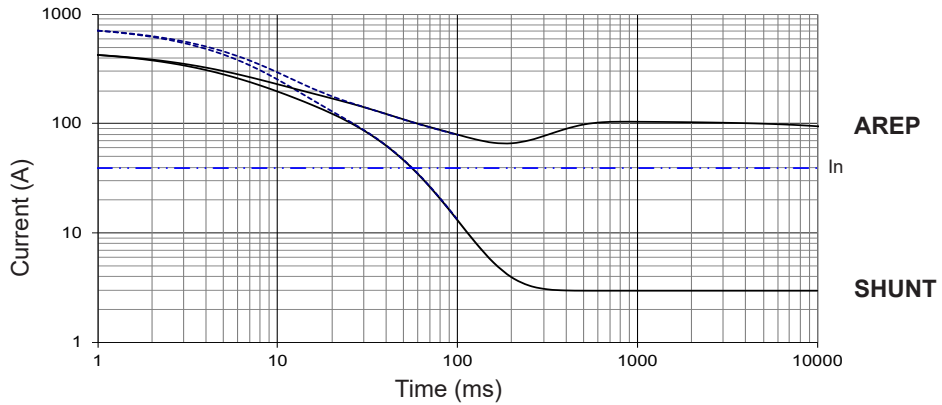

LSA 42.3 VS3

Symmetrical —
Asymmetrical - - -

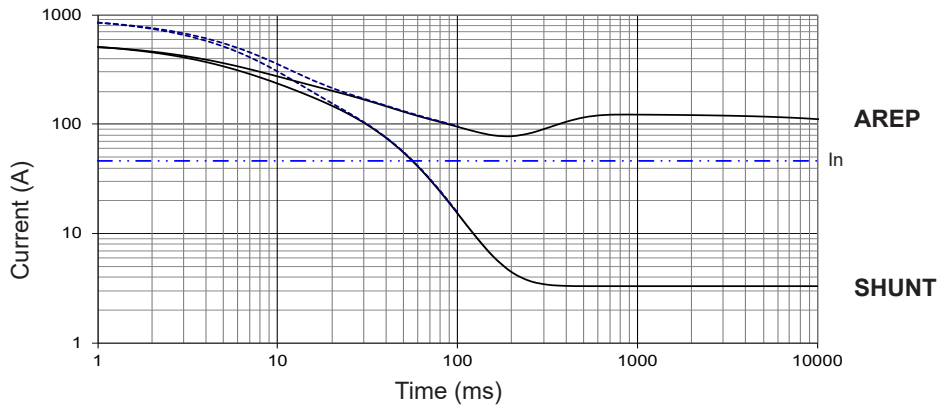

LSA 42.3 S4

Symmetrical —
Asymmetrical - - -

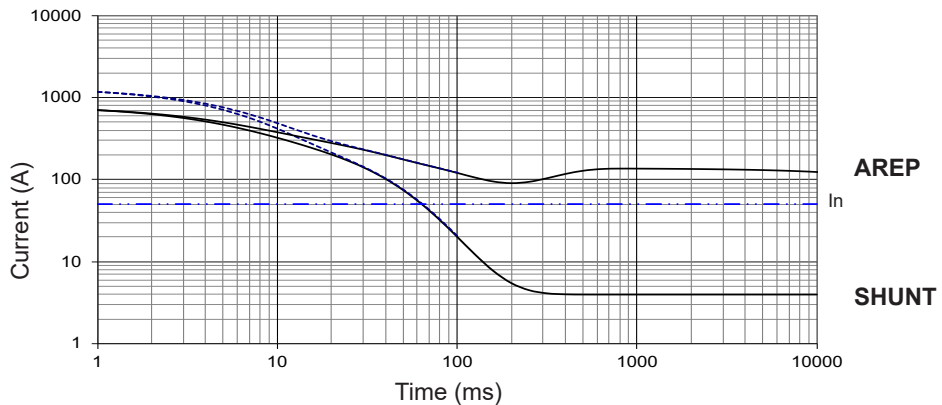

Influence due to connection

Curves shown are for star (Y) connection.

For other connections, use the following multiplication factors:

- Series delta : current value x 1.732 - Parallel star : current value x 2

3-phase short-circuit curves at no load and rated speed (star connection Y)

LSA 42.3 S5

Symmetrical —
Asymmetrical - - -

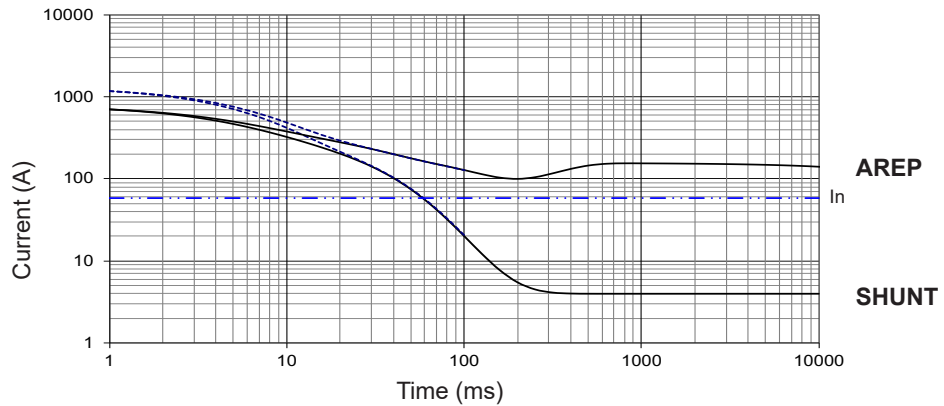

LSA 42.3 M7

Symmetrical —
Asymmetrical - - -

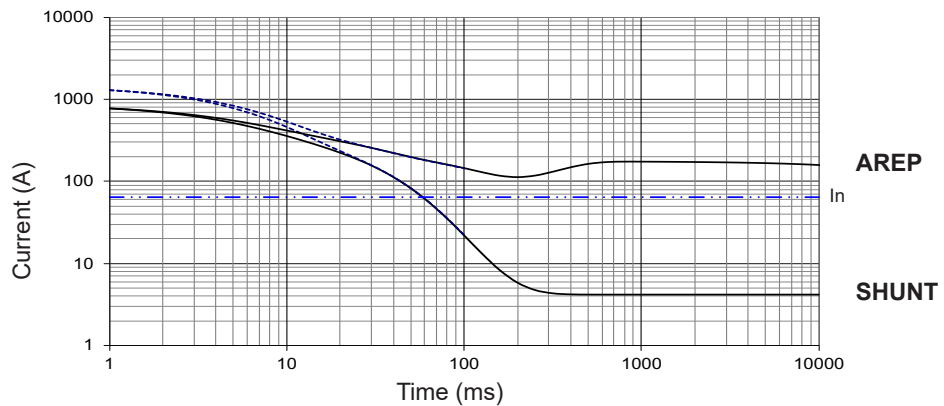

LSA 42.3 M8

Symmetrical —
Asymmetrical - - -

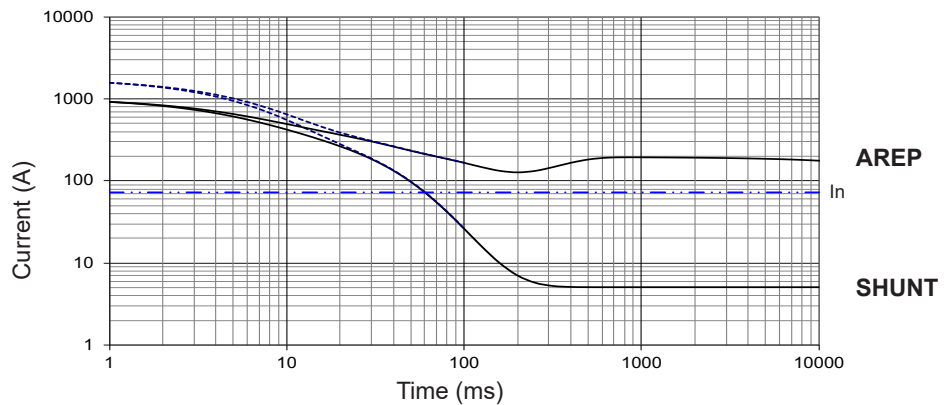

LSA 42.3 L9

Symmetrical —
Asymmetrical - - -

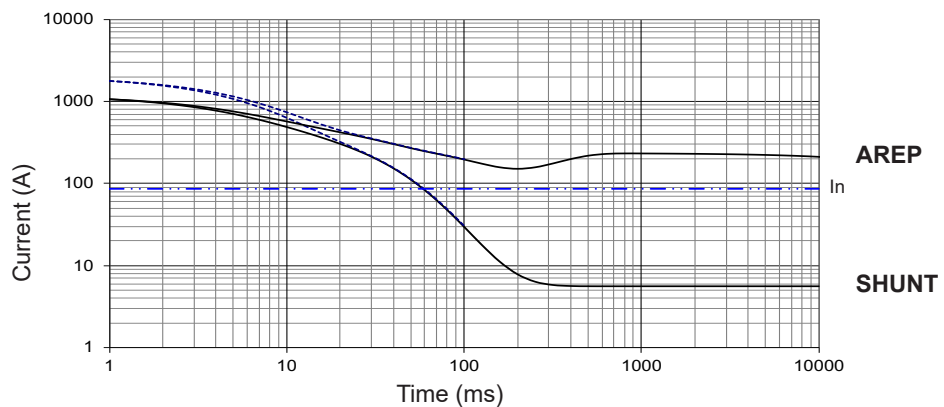

Influence due to short-circuit

Curves are based on a three-phase short-circuit.

For other types of short-circuit, use the following multiplication factors.

	3-phase	2-phase L/L	1-phase L/N
Instantaneous (max.)	1	0.87	1.3
Continuous	1	1.5	2.2
Maximum duration (AREP/PMG)	10 sec.	5 sec.	2 sec.

Single-bearing dimensions

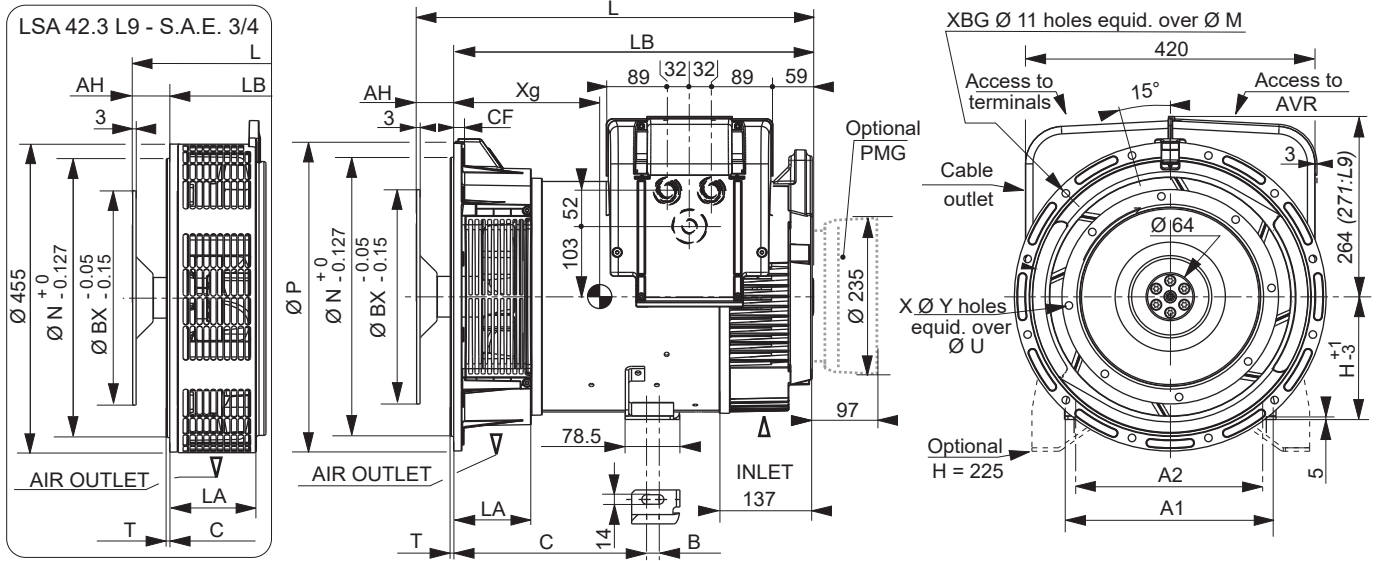

Dimensions (mm) and weight					H = 180 (Standard)				H = 225 (Option)				Coupling			
Type	L without PMG maxi*	LB	Xg	Weight (kg)	C	B	A1	A2	C	B	A1	A2	Flange	2	3	4
LSA 42.3 VS1	565	503	237	117	260	18	307	279	299	23	400	356	Flex plate			
LSA 42.3 VS2	565	503	242	122	260	18	307	279	299	23	400	356	11 1/2	x	x	-
LSA 42.3 VS3	565	503	252	133	260	18	307	279	299	23	400	356	10	x	x	x
LSA 42.3 S4	610	548	275	165	260	18	307	279	312.5	23	400	356	8	-	x	x
LSA 42.3 S5	610	548	275	165	260	18	307	279	312.5	23	400	356	7 1/2	-	x	x
LSA 42.3 M7	650	588	287	181	260	18	307	279	312.5	23	400	356				
LSA 42.3 M8	650	588	295	186	260	18	307	279	312.5	23	400	356				
LSA 42.3 L9**	680	618	310	187	260	18	307	279	312.5	23	400	356				
LSA 42.3 L9***	703	641	300	195	283	18	307	279	335.5	23	400	356				

* L maxi = LB + AH maxi ** S.A.E. 3 *** S.A.E. 4

Flange (mm)							Flex plate (mm)						
S.A.E.	P	N	M	XBG	T	LA	CF	S.A.E.	BX	U	X	Y	AH
4	406/455*	361.95	381	12	5/6	122/128.3*	15/16*	11 1/2	352.42	333.38	8	11	39.6
3	452	409.58	428.62	12	5	105.3*/112.5	12	10	314.32	295.28	8	11	53.8
2	490	447.675	466.725	12	6	111	12	8	263.52	244.48	6	11	62
								7 1/2	241.3	222.25	8	9	30.2

* Specific dimension LSA 42.3 L9

Torsional analysis data

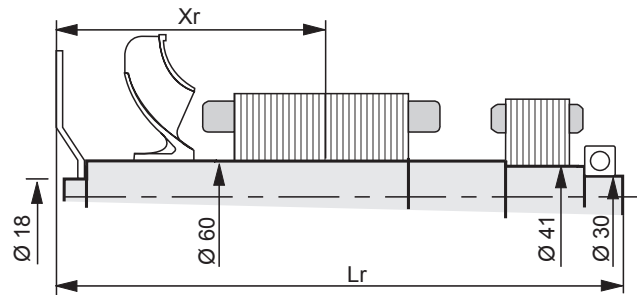

Centre of gravity: Xr (mm), Rotor length: Lr (mm), Weight: M (kg), Moment of inertia: J (kgm ²): (4J = MD ²)																
Flex plate	S.A.E. 7 1/2				S.A.E. 8				S.A.E. 10				S.A.E. 11 1/2			
	Type	Xr	Lr	M	J	Xr	Lr	M	J	Xr	Lr	M	J	Xr	Lr	M
LSA 42.3 VS1	279	526.2	45.36	0.2209	277	558	45.68	0.2246	274	549.8	46.13	0.2363	272	535.6	46.62	0.2883
LSA 42.3 VS2	282	526.2	47.36	0.2337	280	558	47.68	0.2374	277	549.8	48.13	0.2491	274	535.6	48.62	0.2611
LSA 42.3 VS3	287	526.2	51.41	0.2592	286	558	51.73	0.2629	283	549.8	52.18	0.2746	281	535.6	52.67	0.2866
LSA 42.3 S4	310	571.2	61.49	0.317	308	603	61.81	0.3207	306	594.8	62.26	0.3324	304	580.6	62.75	0.3444
LSA 42.3 S5	310	571.2	61.49	0.317	308	603	61.81	0.3207	306	594.8	62.26	0.3324	304	580.6	62.75	0.3444
LSA 42.3 M7	325	611.2	67.41	0.3491	323	643	67.73	0.3528	321	634.8	68.18	0.3645	319	620.6	68.67	0.3765
LSA 42.3 M8	330	611.2	70.42	0.3683	328	643	70.74	0.372	326	634.8	71.18	0.3837	324	620.6	71.68	0.3957
LSA 42.3 L9	344	641.2	77.49	0.4141	342	673	77.81	0.4178	340	664.8	78.25	0.4295	338	650.6	78.75	0.4415

NOTE : Dimensions are for information only and may be subject to modifications. Contractual 2D drawings can be downloaded from the Leroy-Somer site, 3D drawing files are available upon request. The torsional analysis of the transmission is imperative. All values are available upon request.

Two-bearing dimensions

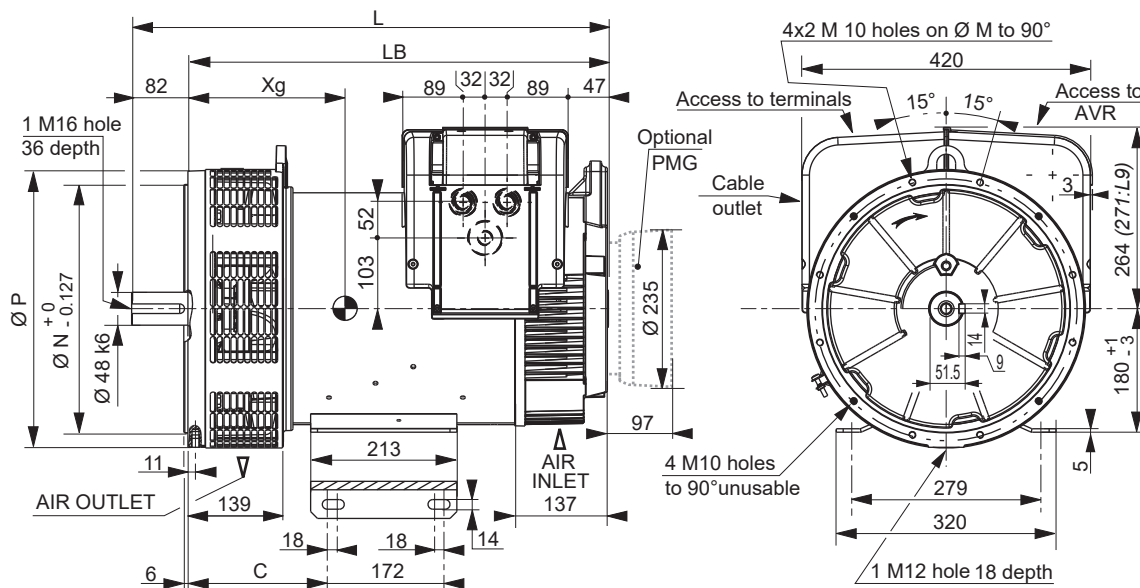

Dimensions (mm) and weight

Type	L without PMG	LB	N	M	P	C	Xg	Weight (kg)
LSA 42.3 VS1	610	528	361.95	381	406	189.25	242	129
LSA 42.3 VS2	610	528	361.95	381	406	189.25	247	134
LSA 42.3 VS3	610	528	361.95	381	406	189.25	257	145
LSA 42.3 S4	655	573	361.95	381	406	202.75	280	170
LSA 42.3 S5	655	573	361.95	381	406	202.75	280	170
LSA 42.3 M7	695	613	361.95	381	406	202.75	292	185
LSA 42.3 M8	695	613	361.95	381	406	202.75	300	190
LSA 42.3 L9	725	643	409.58	428.62	455	202.75	314	207

Torsional analysis data

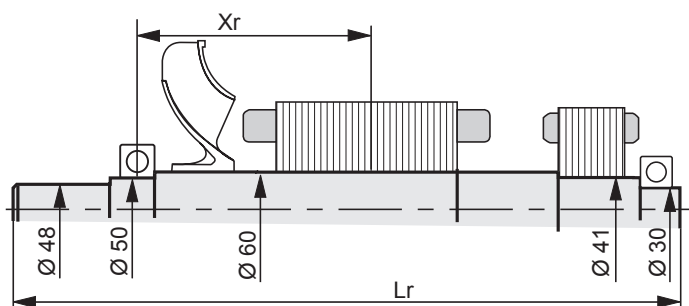

Centre of gravity: Xr (mm), Rotor length: Lr (mm), Weight: M (kg), Moment of inertia: J (kgm²): (4J = MD²)

Type	Xr	Lr	M	J
LSA 42.3 VS1	238	603	45.18	0.2135
LSA 42.3 VS2	240	603	47.18	0.2263
LSA 42.3 VS3	245	603	51.23	0.2518
LSA 42.3 S4	267	648	61.31	0.3096
LSA 42.3 S5	267	648	61.31	0.3096
LSA 42.3 M7	281	688	67.23	0.3417
LSA 42.3 M8	286	688	70.23	0.3609
LSA 42.3 L9	299	718	77.29	0.4066

NOTE : Dimensions are for information only and may be subject to modifications. Contractual 2D drawings can be downloaded from the Leroy-Somer site, 3D drawing files are available upon request.
The torsional analysis of the transmission is imperative. All values are available upon request.

LEROY-SOMER[™]

www.leroy-somer.com/epg

Connect with us at:



Nidec
All for dreams

© 2022 Moteurs Leroy-Somer SAS. The information contained in this brochure is for guidance only and does not form part of any contract. The accuracy cannot be guaranteed as Moteurs Leroy-Somer SAS have an ongoing process of development and reserve the right to change the specification of their products without notice.

Moteurs Leroy-Somer SAS. Headquarters: Bd Marcellin Leroy, CS 10015, 16915 Angoulême Cedex 9, France. Share Capital: 38,679,664 €, RCS Angoulême 338 567 258.