

STANDARD ACCESSORIES



DSE9470 MKII

24 Volt, 10 Amp Battery Charger



ADVANCED FEATURES

- UL recognised (9470-01 USA / 9470-A4 USA & Canada)
- Intelligent three and four stage charging profiles
- Configurable to suit 12V/24V - 5A/10A applications
- Adjustable current limit
- Can be used as a battery charger, power supply or both at the same time
- Automatic or manual boost and storage charge functions to help maintain battery condition
- Digital microprocessor technology
- Temperature compensation for battery charging
- Low output ripple and superb line regulation
- Three LED indicators
- Switched mode design
- Fully customisable battery charging curves
- Battery health check
- Battery voltage sensing
- Deep sleep mode
- PSU only mode
- Automatic voltage detection
- Wide output current range

Full Protection

- AC input under voltage
- AC input over voltage
- Battery charger output over voltage
- Battery charger output over current
- Battery under voltage alarm
- Automatic battery detection
- Automatic battery charger self test
- Output short circuit and inversion polarity with auto recovery
- Max current mode
- SCADA digital input status information
- Automatic power de-rating at high ambient temperatures.
- Optional battery temperature compensation using PT1000 temperature sensor with over temperature protection

Automatic Boost Mode

- Boosts and equalises cell charge, improving battery performance

Power Save Mode

- Once the battery is fully charged, the chargers switch to eco-power to save energy

Communication

- Can be integrated into external systems through MODBUS RTU using RS485

- Fully configurable via DSE Configuration Suite PC Software
- External remote display option - DSE2541

KEY BENEFITS

- Fully flexible to maximise the life of the battery
- Suitable for a wide range of battery types
- Minimum 86% efficiency throughout full operating range
- No external intervention for boost mode
- Multiple chargers can be linked together to provide larger current outputs
- Can be permanently connected to a battery and AC supply. No need to disconnect through high load conditions such as cranking or when the engine is running.

SPECIFICATIONS

AC SUPPLY

VOLTAGE RANGE
90 V to 305 V (L to N)

FREQUENCY RANGE
48 Hz to 64 Hz (L to N)

DC OUTPUT

10 A DC at 24 V DC (Configurable)

RIPPLE AND NOISE
<1%

EFFICIENCY
>86%

REGULATION LINE
<0.5%

LOAD
2%

TEMPERATURE SENSOR INPUT
PT1000

PROTECTIONS

Short circuit
DC over voltage
DC over current
Reverse polarity
Over temperature
AC under & over voltage

CHARGE FAILURE RELAY
3 A at 30 V DC volt free relay

DIMENSIONS

OVERALL
70 mm x 200 mm x 130 mm
2.7" x 7.9" x 5.1"

WEIGHT
0.75 kg

OPERATING TEMPERATURE RANGE

-30 °C to +70 °C
-22 °F to +158 °F

STORAGE TEMPERATURE RANGE

-30 °C to +70 °C
-22 °F to +158 °F

UL VOLTAGE APPROVAL RATINGS

USA ONLY (9470-01)
110 V - 250 V
USA & CANADA (9470-A4)
110 V - 150 V

RELATED MATERIALS

TITLE	PART NO.
DSE9400 Series Configuration Suite PC Software Manual	057-159
DSE Configuration Suite Installation & Operators Manual	057-151
DSE9000 Series Installation Instructions	053-049
DSE9000 Series Operators Manual	057-085

DEEP SEA ELECTRONICS LTD UK

Highfield House, Hunmanby Industrial Estate, Hunmanby YO14 0PH

TELEPHONE +44 (0) 1723 890099

EMAIL sales@deepseaelectronics.com **WEBSITE** www.deepseaelectronics.com

DEEP SEA ELECTRONICS INC USA

3230 Williams Avenue, Rockford, IL 61101-2668 USA

TELEPHONE +1 (815) 316 8706 **FACSIMILE** +1 (815) 316 8708

EMAIL usasales@deepseaelectronics.com **WEBSITE** www.deepseaelectronics.com

DSE9470 MKII

24 Volt, 10 Amp Battery Charger

The DSE9470 MKII is a UL recognised intelligent battery charger fully configurable for 12 Volt/ 24 Volt & 5 Amp / 10 Amp applications.

There are two different UL recognised variants. The 9470-01 is recognised for USA only (110 V - 250 V) and the 9470-A4 is recognised for USA & Canada (110 V - 150 V).

The charger features automatic voltage detection and battery voltage sensing down to 1 volt and has an output current range that can go down to 1 amp. The charger can be easily programmed for different charging curves, to maximise battery life.

The charger can be DIN rail or chassis mounted, using the fixing holes that are built into the case. The charger includes three coloured LEDs to indicate charging status and fault conditions.

The chargers do not include any moving parts for additional durability and reliability. Each charger will continue to operate during engine running.

Multiple chargers can be linked together to provide a larger current output where required.

The battery chargers are programmed using the user-friendly DSE Configuration Suite PC software.

PART NUMBERS

9470-01
24 V 10 A Battery Charger
(110 V - 250 V UL Recognised - USA)

9470-A4
24 V 10 A Battery Charger
(110 V - 150 V UL Recognised - USA & Canada)

ENVIRONMENTAL TESTING STANDARDS

ELECTRO-MAGNETIC COMPATIBILITY

BS EN 61000-6-2
EMC Generic Immunity Standard for the Industrial Environment
BS EN 61000-6-4
EMC Generic Emission Standard for the Industrial Environment

OPERATING TEMPERATURE RANGE

BS EN 60068-2-1
Ab/Ae Cold Test -30 °C
BS EN 60068-2-2
Bb/Be Dry Heat +80 °C
* Refer to de-rating curve in the DSE9000 Operator Manual

VIBRATION

BS EN 60068-2-6
Ten sweeps in each of three major axes
5 Hz to 8 Hz @ +/-7.5 mm,
8 Hz to 500 Hz @ 2 gn

HUMIDITY

BS EN 60068-2-30
Db Damp Heat Cyclic 20/55 oC
@ 95% RH 48 Hours
BS EN 60068-2-78
Cab Damp Heat Static 40 oC
@ 93% RH 48 Hours

SHOCK

BS EN 60068-2-27
Three shocks in each of three major axes
15 gn in 11 ms

COMPREHENSIVE FEATURE LIST TO SUIT A WIDE VARIETY OF BATTERY CHARGER APPLICATIONS

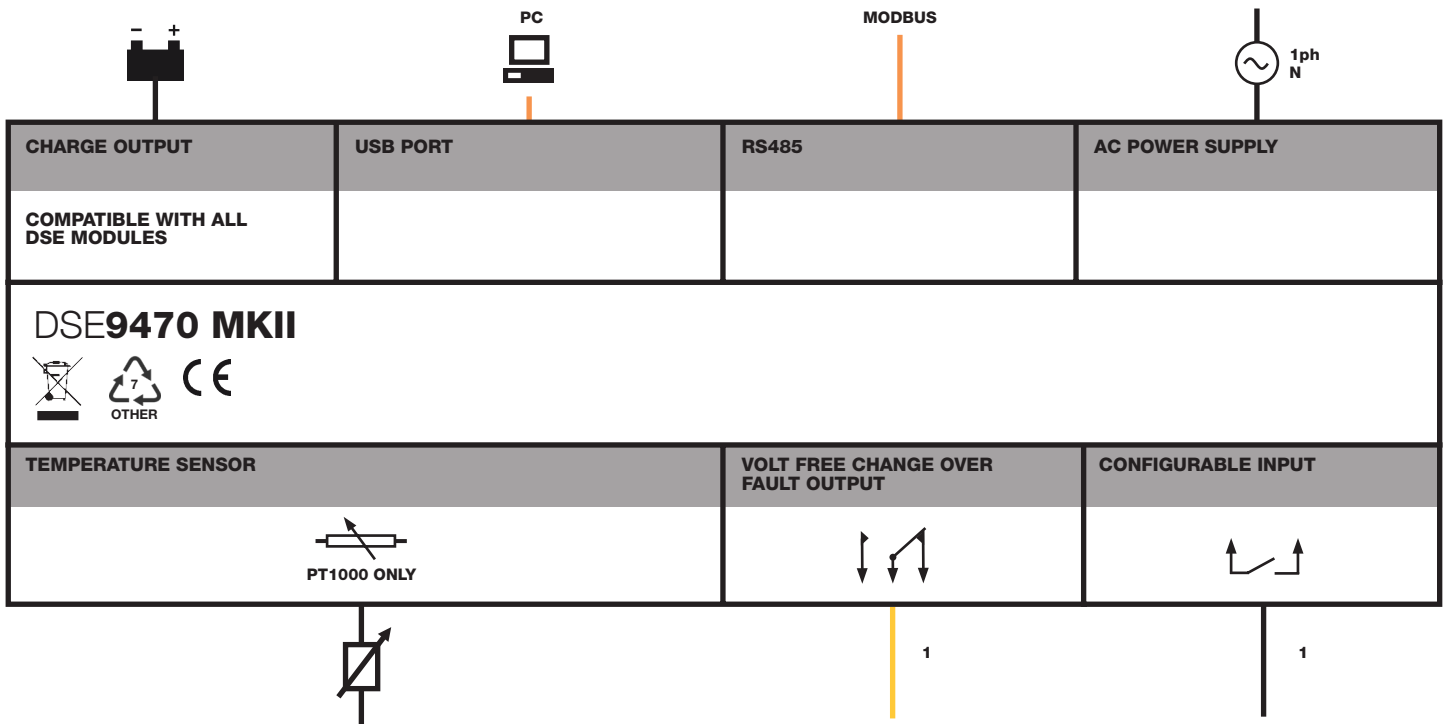

HOTflow[®] Heating System CTM



Hotstart's CTM HOTflow[®] heating system is a coolant preheater, developed to maintain optimal temperatures for diesel and gas engines in stationary land power, marine, and construction equipment applications.



COMPACT CAPABILITY

Despite its small footprint, efficient forced circulation allows the CTM to heat engines up to 20 liters in displacement, allowing for a wide variety of small-engine applications.



VERSATILE & ADAPTABLE

The CTM can be configured for almost any weather-protected application. Multiple options are available, including UL/C-US listed and CE-compliant models.



EASY INSTALLATION

The CTM's inlet and outlet may be reoriented at 90° increments to accommodate heater plumbing. The included mounting kit is ideal for most installations; an optional vibration isolation kit is also available.



LOWER TOTAL COST OF OWNERSHIP

Forced circulation provides uniform heat throughout the engine, reducing component maintenance and offering significant energy savings. The CTM may reduce end-user utility costs by up to 35%¹.

¹ Savings are dependent on local utility rates and installation variables.

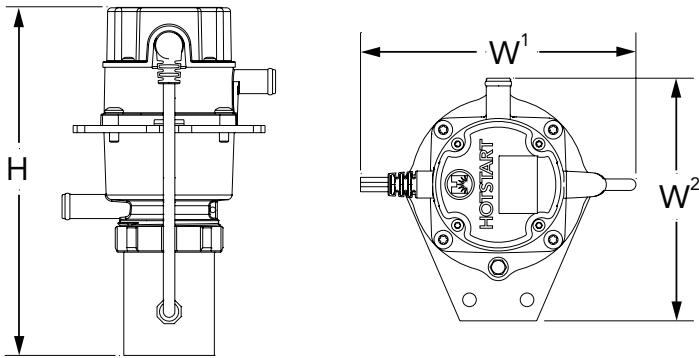

Height (H)	Width 1 (W ¹)	Width 2 (W ²)	Weight
9.1"	5.7"	6.3"	3.5 lbs
230 mm	145 mm	161 mm	1.6 kg

System	
Phase	single-phase (1 Ø)
Voltage (60 Hz)	120V 240V
Voltage (50 Hz)	240V
Ingress	IP44
Min./Max. Ambient Temp	-40 °F / 104 °F (-40 °C - 40 °C)
Application	for use in weather protected applications
Certification	UL/C-US recognized models available (E250789) CE-compliant models available

Coolant	
Fluid Type	Water Coolant mix (50% water/50% glycol)
Heat Power	1 kW 1.5 kW 2.5 kW
Temp. Control	Fixed, 100 – 120 °F (38–49°C)
Temp. High Limit	300 °F (149°C)
Flow	3.5 gpm @ 4 psi (13.3 L/min @ 28 kPa)
Inlet/Outlet	0.625" (16 mm) hose barb

Vibration Isolation Kit

CTM IMK

Optional kit protects heating system from damaging engine vibration. For use in mobile applications or non-isolated stationary skid installations.

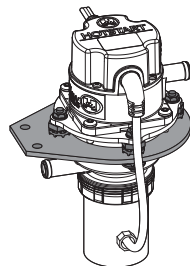

Ordering Information
CTM

CTM with 8' (2.4 m) cord and NEMA plug* (-N00)

Engine Displacement	Power Supply			Heating System	
	V	Hz	kW	Amps	Model Number
0–500 CID 0–8 L	120	60	1	8.8	CTM10110-N00
	240	50/60	1	4.4	CTM10210-N00
500–750 CID 8–12 L	120	60	1.5	13.0	CTM15110-N00
	240	50/60	1.5	6.5	CTM15210-N00
750–1000 CID 12–20 L	120	60	2.5	21.3	CTM25110-N00
	240	50/60	2.5	10.7	CTM25210-N00

CTM with 9.8' (3 m) cord and Euro plug (-E00)**

Engine Displacement	Power Supply			Heating System	
	V	Hz	kW	Amps	Model Number
0–500 CID 0–8 L	120	60	1	8.8	CTM10110-E00
	240	50/60	1	4.4	CTM10210-E00
500–750 CID 8–12 L	120	60	1.5	13.0	CTM15110-E00
	240	50/60	1.5	6.5	CTM15210-E00
750–1000 CID 12–20 L	120	60	2.5	21.3	CTM25110-E00
	240	50/60	2.5	10.7	CTM25210-E00

CTM with 9.8' (3 m) cord and no plug (-A00)

Engine Displacement	Power Supply			Heating System	
	V	Hz	kW	Amps	Model Number
0–500 CID 0–8 L	120	60	1	8.8	CTM10110-A00
	240	50/60	1	4.4	CTM10210-A00
500–750 CID 8–12 L	120	60	1.5	13.0	CTM15110-A00
	240	50/60	1.5	6.5	CTM15210-A00
750–1000 CID 12–20 L	120	60	2.5	21.3	CTM25110-A00
	240	50/60	2.5	10.7	CTM25210-A00

* – UL/C-US listed
** – CE compliant

Other voltages available.
Consult the factory.



D350 DIGITAL AVR FOR ALTERNATORS WITH SHUNT, AREP OR PMG EXCITATION

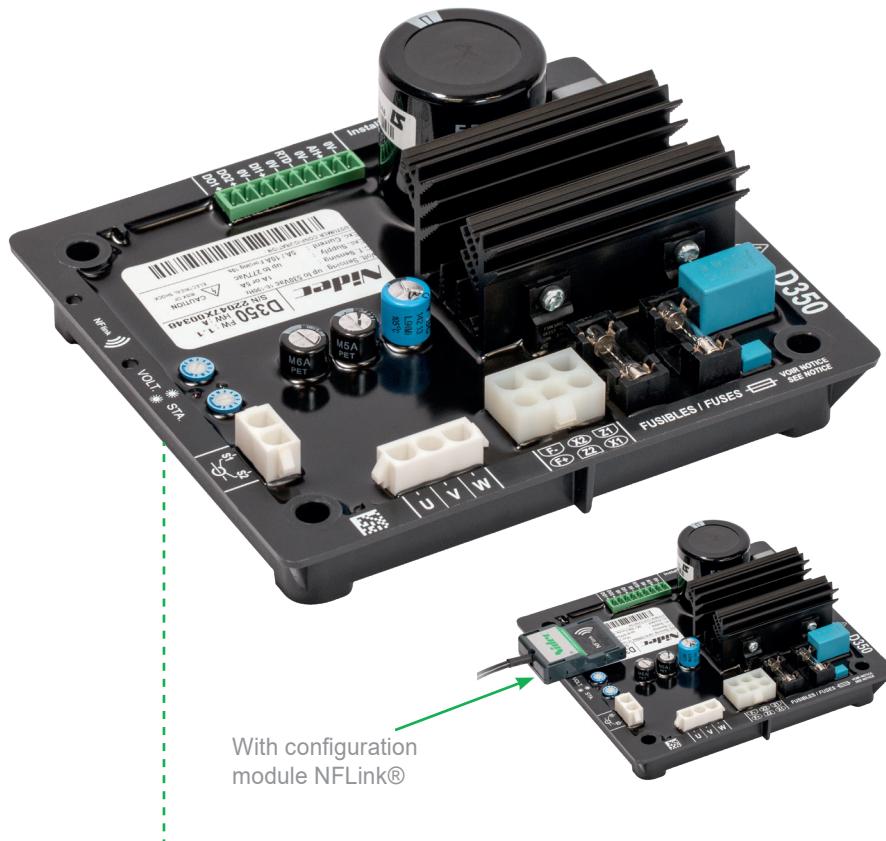

With configuration module NFLink®

KEY FEATURES

- Rated excitation current: 5 A
- Maximum excitation current: 10 A for 10 s
- Voltage regulation accuracy: $\pm 0.25\%$
- Excitation: SHUNT, AREP or PMG
- Voltage sensing: three-phase or single-phase - 530 VAC max.
- CT input: yes (1 A and 5 A)
- Mate-N-Lok connectors
- Quadrature droop function
- Over-excitation protection
- Loss of sensing
- Stator current monitoring
- U/F function
- LAM function
- Soft Start function
- Voltage soft recovery
- Two configuration modes can be activated by a digital input (eg. 50/60 Hz)
- Event logger

The D350 is a digital automatic voltage regulator (AVR) for alternators which require rated field current up to 5 A.

It offers numerous control and protection functions for the various components of generator sets, especially for managing short-circuits and load impacts.

The D350 can be configured using the Nidec Leroy-Somer EasyReg Advanced software.

For easier maintenance and investigations in the event of problems, the D350 also offers an event logger function and an NFLink® wireless communication module for setting parameters and retrieving data.

The D350 conforms to standard IEC 60034-1 and is certified UL508 and CSA.

CONNECTIONS AND COMMUNICATION

- Inputs:
 - 1 x analog input
 - 1 x digital input
 - 1 x thermal sensor input (configurable in PT100 or PTC)
- Outputs:
 - 2 x digital outputs
- Event logger
- NFLink® module for configuration
- Mate-N-Lok connectors

OPERATION CONDITIONS

- Operating temperature range: -40°C to +65°C
- Storage temperature range: -55°C to +85°C
- Hygrometry: up to 98%
- Maximum impact: 9 g on 3 axis

OPERATION RANGE

	LSA 40	LSA 42.3	LSA 44.3	LSA 46.3	LSA 47.3	LSA 49.3	LSA 50.2
SHUNT	✓	✓	✓	✓	✓	✓	✓
AREP	✓	✓	✓	✓	✓	✓	✓
PMG	-	✓	✓	✓	✓	✓	✓
	TAL 040	TAL 042	TAL 044	TAL 046	TAL 0473	TAL 049	
SHUNT	✓	✓	✓	✓	✓	✓	
AREP+	✓	✓	✓	✓	✓	✓	
PMG	-	✓	✓	✓	✓	✓	
	LSAH 42.3	LSAH 44.3					
AREP	✓	✓					

DIMENSIONS

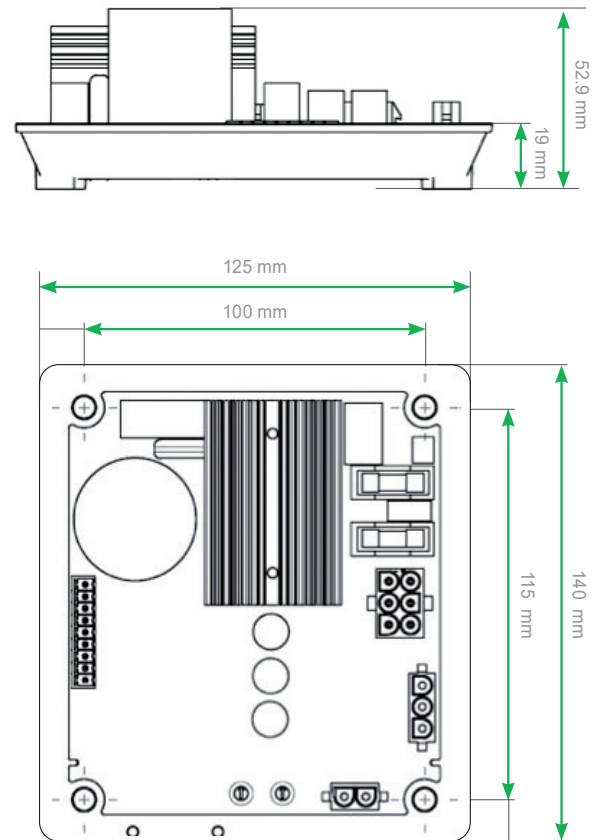
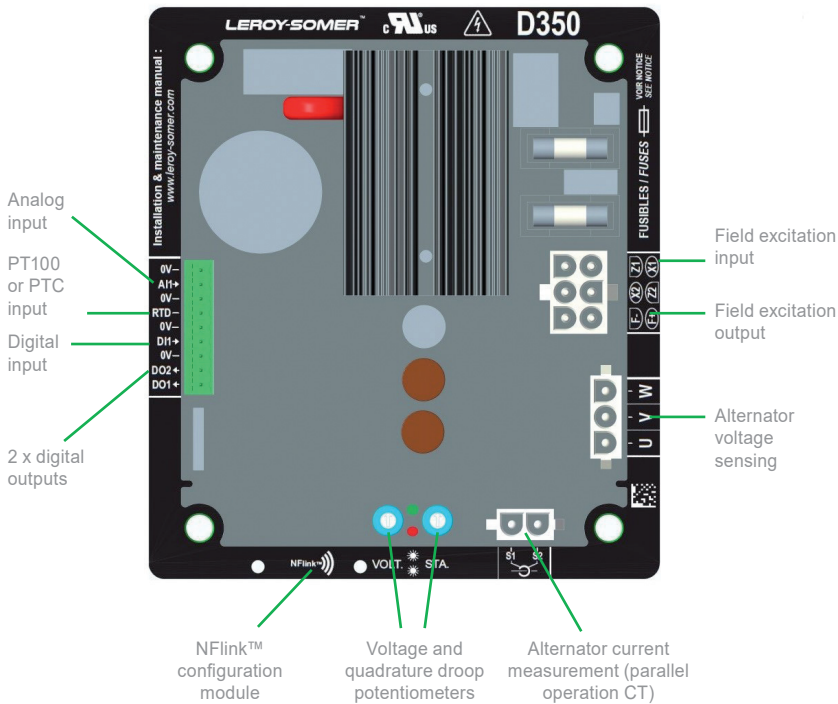

SYSTEM BATTERIES



TEKSAN gensets equipped with fully closed, maintenance-free lead acid batteries.

TEKSAN selects batteries according to engine manufacturer's recommendation and to comply NFPA requirements.



Genset Model	BATTERY			Genset Model	BATTERY		
	CCA	Size	Type		CCA	Size	Type
TJUD9P	350A	(1)47Ah	NS60	TJUD250P	860A	(2)102Ah	L5
TJUD13P	350A	(1)47Ah	NS60	TJUD275P	860A	(2)102Ah	L5
TJUD20P	700A	(1)75Ah	LB3	TJUD300P	860A	(2)102Ah	L5
TJUD25P	700A	(1)75Ah	LB3	TJUD315P	860A	(2)102Ah	L5
TJUD28P	700A	(1)75Ah	LB3	TJUD350P	860A	(2)102Ah	L5
TJUD30P	700A	(1)75Ah	LB3	TJUD400P	860A	(2)102Ah	L5
TJUD50P	700A	(1)75Ah	LB3	TJUD450P	860A	(2)102Ah	L5
TJUD55P	700A	(1)75Ah	LB3	TJUD500P	860A	(2)102Ah	L5
TJUD60P	700A	(1)75Ah	LB3	TJUD530P	860A	(2)102Ah	L5
TJUD65P	700A	(1)75Ah	LB3	TJUD550P	860A	(2)102Ah	L5
TJUD80P	700A	(1)75Ah	LB3	TJUD600P	(2)860A	(4)102Ah	L5
TJUD100P	700A	(1)75Ah	LB3	TJUD750P	(2)860A	(4)102Ah	L5
TJUD125P	860A	(1)102Ah	L5	TJUD800P	(2)860A	(4)102Ah	L5
TJUD150P	860A	(1)102Ah	L5	TJUD865P	(2)860A	(4)102Ah	L5
TJUD160P	860A	(1)102Ah	L5	TJUD900P	(2)860A	(4)102Ah	L5
TJUD175P	860A	(1)102Ah	L5	TJUD1000P	(2)860A	(4)102Ah	L5
TJUD180P	860A	(1)102Ah	L5				
TJUD200P	860A	(1)102Ah	L5				
TJUD300H	860A	(2)102Ah	L5	TJUD750H	(2)860A	(4)102Ah	L5
TJUD325H	860A	(2)102Ah	L5	TJUD800H	(2)860A	(4)102Ah	L5
TJUD350H	860A	(2)102Ah	L5	TJUD900H	(2)860A	(4)102Ah	L5
TJUD400H	860A	(2)102Ah	L5				
TJUD800B	(2)860A	(4)102Ah	L5	TJUD1000B	(2)860A	(4)102Ah	L5
TJUD900B	(2)860A	(4)102Ah	L5	TJUD1250B	(2)860A	(4)102Ah	L5

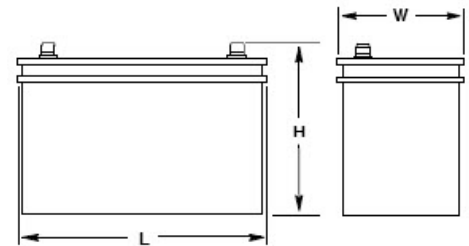

Genset Model	BATTERY			Genset Model	BATTERY		
	CCA	Size	Type		CCA	Size	Type
TJUG25PS	700A	(1)75Ah	LB3	TJUG200PS	860A	(2)102Ah	L5
TJUG40PS	700A	(1)75Ah	LB3	TJUG200PD	860A	(2)102Ah	L5
TJUG60PS	700A	(1)75Ah	LB3	TJUG250PS	860A	(2)102Ah	L5
TJUG80PS	700A	(1)75Ah	LB3	TJUG275PD	860A	(2)102Ah	L5
TJUG100PS	700A	(1)75Ah	LB3	TJUG300PD	860A	(2)102Ah	L5
TJUG115PS	860A	(1)102Ah	L5	TJUG350PD	860A	(2)102Ah	L5
TJUG125PS	860A	(1)102Ah	L5	TJUG400PD	860A	(2)102Ah	L5
TJUG150PS	860A	(1)102Ah	L5	TJUG450PD	860A	(2)102Ah	L5
TJUG200PN	860A	(1)102Ah	L5	TJUG500PD	860A	(2)102Ah	L5

BATTERY DIMENSIONS			
Type	L	W	H
NS60	238mm / 9.4"	129mm / 5.1"	224mm / 8.8"
LB3	278mm / 11"	175mm / 6.9"	175mm / 6.9"
L5	352mm / 13.9"	175mm / 6.9"	190mm / 7.5"



Attention: Batteries must always be kept under a buffer charge. Batteries on a genset that is stored for a long period of time, must be re-charged to prevent corruption on battery plates and become out of use.

BATTERY TECHNICAL DATA SHEET		Date: 24/05/2013		
		Number: 1		
Customer: TEKSAN		Type: L5		
INCI Reference: 1005886		12 V 102 AH 860A (EN)		
Dimensions: 352*175*190 (L*W*TH)				
CONTAINER	Box	Color:	GREY	
		Hold Down:	B13	
		Material:	PP	
Lid		Type:	SEALED	
		Polarity:	0	
		Color:	GREY	
	Material:	PP		
Plug		Type:	6x1 Plug set	
		Color:	GREY	
		Material:	PP	
CELL	Plate number per cell	Positive:	10	
		Negatives:	10	
	Plate dimensions	Height x Length:	100x144 mm	
		Positive thicknes:	1.76mm	
		Negative thickness:	1.48mm	
Grid Alloy	Positives:	PbSbCa		
	Negatives:	PbCa		
Separator	Type:	PE		
	Thickness:	0.9 mm		
	Enveloped plate:	Negative		
Plate Blocking	Hot Melt on top:	NO		
MASS	Total Battery:	22,93	kg (MAX)	

		
B200E		
Product	Control Unit	
Model	Emergency	
Type	Turn to Release	
Contact	1NC	
Color	Red	
Dia	22 mm	
Head Dia	40 mm	
Current	Ie	4 A (250V AC)
Usage Category	AC 15	
Mechanical Life	Min Qty	500000
Electrical Life	Min Qty	100000
Operating Frequency	On-Off/Hour	Mech. 1200 Elec. 1200
Insulation Voltage	Ui	300V
Impulse Withstand Voltage	Uimp	2.5 kV
Dielectric Strength (Body-Contact)	2.500V AC	
Dielectric Strength (Contact-Contact)	1.500V AC	
Isolation Resistance	10 MΩ min. (500V DC)	
Operating Temperature	-15 / + 80 °C	
Pollution Degree	3	
Protection Degree	IP50	
Contact Material	AgNi	
Cable Section	1.5-2.5 mm ²	
Screw Torque	1,5 Nm	
Short Circuit Breaking Capacity	Ics	1 kA
Production Time	31.12.1899 00:00:00	
Serial	B Series Plastic	
Specifications	Non-flammable V0 PA6.6 contact blocks	
	Various illumination contact blocks availability	
	Variety of products for all areas of application	
Standards / Certificates	IEC 60947-5-1 TS EN 60947-5-1 UL 508 VDE 0660	
