

ALTERNATOR DATASHEET

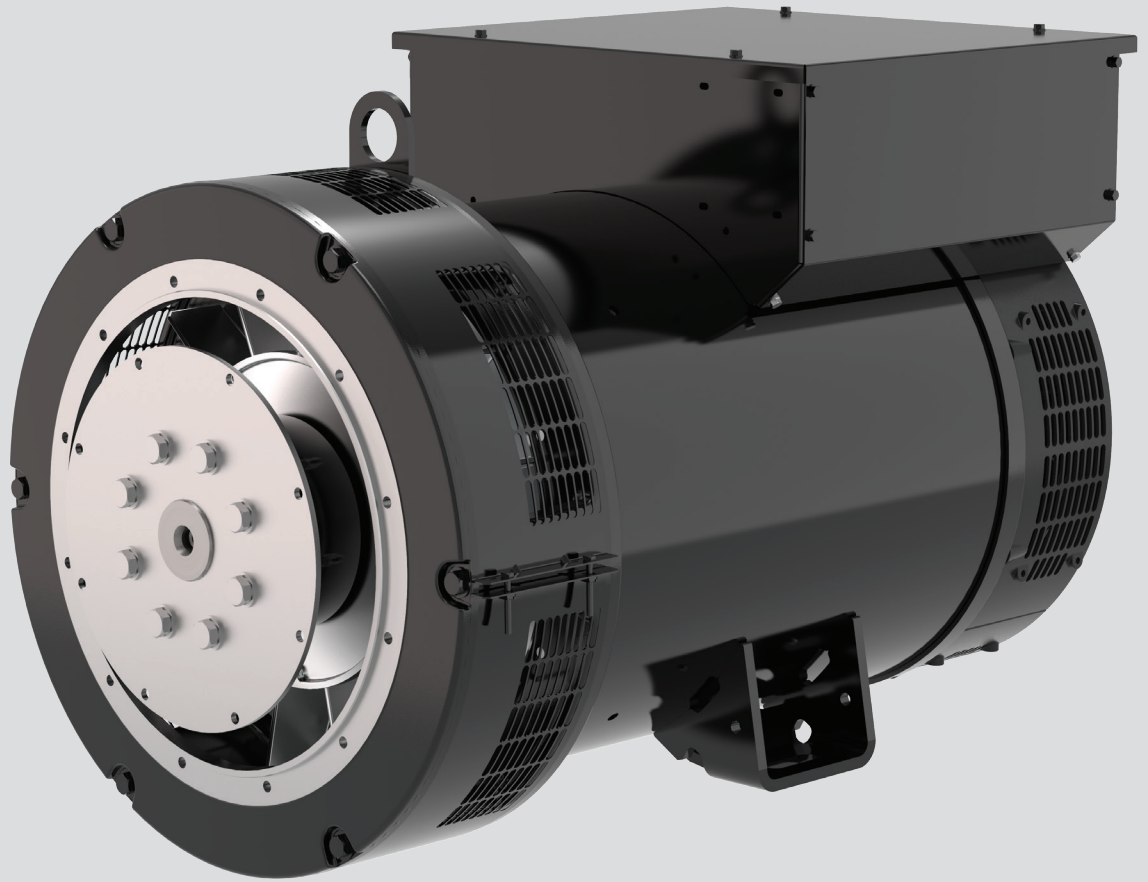



TAL 046

Low Voltage Alternator - 4 pole

230 to 365 kVA - 50 Hz / 288 to 438 kVA - 60 Hz
Electrical and mechanical data

LEROY-SOMER[™]

Nidec
All for dreams

The best of performance

Nidec Leroy-Somer TAL 046 alternator has been designed to offer you the best power generation performances. With its meticulous design and optimized architecture, the TAL 046 strikes the perfect balance between compactness, reliability, performance and longevity. Whatever your application, the TAL 046 will meet your needs and will adapt to all situations.

Standards

Nidec Leroy-Somer TAL 046 alternator meets all key international standards and regulations, including IEC 60034, NEMA MG 1.32-33, ISO 8528-3, CSA C22.2 n° 100-14 and UL 1446 (UL 1004 on request). Also compliant with IEC 61000-6-2, IEC 61000-6-3, IEC 61000-6-4, VDE 0875G, VDE 0875N and EN 55011, group 1 class A for European zone. Nidec Leroy-Somer TAL 046 alternator can be integrated in EC marked generator set, and bears EC, EAC and CMIM markings. It is designed, manufactured and marketed in an ISO 9001 and ISO 14001 quality assurance environment.

Electrical characteristics and performances

- Class H insulation
- Shunt excitation
- Low voltage winding:
 - Three-phase 50 Hz: 220V - 240V and 380V - 415V (440V)
 - 60 Hz: 208V - 240V and 380V - 480V
- 6-terminal plates in 6-wire version or suitable for 12-wire option
- Optimized performance

Excitation and regulation system

	Excitation system				Regulation options		
	AVR	SHUNT	AREP+ (option)	PMG (option)	UL _{C/US}	Remote voltage potentiometer	C.T. Current transformer for paralleling
Three-phase 6-wire	R150	Standard				√	
	R180		Standard	Standard		√	√
	D350	Option	Option	Option	√	√	√*
Three-phase 12-wire**	R150	Standard				√	
	R250	Option			√	√	
	R180		Standard	Standard		√	√
	D350	Option	Option	Option	√	√	√*

*: only with AREP+ or PMG **: with larger terminal box

Protection system and options

- Degree of protection: IP 23
- Complete winding protection for non-harsh environments with relative humidity ≤ 95%
- Options:
 - Three-phase 12-wire with 9-terminal plates
 - AREP+ or PMG excitation
 - UL_{C/US}
 - Customized painting (unpainted machine as standard)
 - Space heater
 - Droop kit for alternator paralleling
 - Stator sensors
 - Winding 8 optimized for three-phase 380V / 416 V - 60 Hz
 - Reinforced winding protection for harsh environments and relative humidity greater than 95% (system 2 - 4): for TAL 046 H apply a derating coefficient of 0.97

Mechanical construction

- Compact and rugged assembly to withstand engine vibrations
- Steel frame
- Cast iron flanges and shields
- Single-bearing design to be suitable with most diesel engines
- Greased for life bearings
- Direction of rotation: clockwise and counterclockwise without derating

Terminal box design

- Easy access to AVR and terminals
- Standard terminal box with possibility of mounting measurement CTs
- Possibility of current transformer for parallel operation



TAL 046 - 230 to 365 kVA - 50 Hz / 288 to 438 kVA - 60 Hz

General characteristics

Insulation class	H	Excitation system 6-wire	SHUNT	AREP+ / PMG
Winding pitch	2/3 (wind.6S - 6-wire / wind.6 - 12-wire)	AVR type	R150	R180
Number of wires	6 (12 option)	Excitation system 12-wire (option)	SHUNT	AREP+ / PMG
Protection	IP 23	AVR type	R150	R180
Altitude	≤ 1000 m	Voltage regulation (**)	± 0.8 %	± 0.5 %
Overspeed	2250 R.P.M.	Total Harmonic Distortion THD (***) in no-load	< 2.5 %	
Air flow 50 Hz	0.48 m³/s	Total Harmonic Distortion THD (***) in linear load	< 5 %	
Air flow 60 Hz	0.58 m³/s	Waveform: NEMA = TIF (***)	< 50	
AREP+/PMG Short-circuit current = 2.7 In: 5 seconds (*)		Waveform: I.E.C. = THF (***)	< 2%	

(*) D350: 10 seconds (**) Steady state (***) Total harmonic distortion between phases, no-load or on-load (non-distorting)

Ratings 50 Hz - 1500 R.P.M.

kVA / kW - P.F. = 0.8

Duty / T° C	Continuous / 40 °C					Continuous / 40 °C					Stand-by / 40 °C					Stand-by / 27 °C				
Class / T° K	H / 125° K					F / 105° K					H / 150° K					H / 163° K				
Phase	3 ph.			1 ph.		3 ph.			1 ph.		3 ph.			1 ph.		3 ph.			1 ph.	
Y	380V	400V	415V	440V		380V	400V	415V	440V		380V	400V	415V	440V		380V	400V	415V	440V	
Δ	220V	230V	240V		230V	220V	230V	240V		230V	220V	230V	240V		230V	220V	230V	240V		230V
YY (*)	200V			220V		200V			220V		200V			220V		200V			220V	
ΔΔ (*)					230V					230V					230V					230V
TAL 046 C kVA	230	230	230	219	138	209	209	209	199	126	244	244	244	232	146	253	253	253	241	152
kW	184	184	184	175	110	167	167	167	159	101	195	195	195	186	117	202	202	202	193	122
TAL 046 D kVA	240	250	250	238	150	218	228	228	217	137	254	265	265	252	159	264	275	275	262	165
kW	192	200	200	190	120	174	182	182	174	110	203	212	212	202	127	211	220	220	210	132
TAL 046 E kVA	275	275	275	261	165	250	250	250	238	150	292	292	292	277	175	303	303	303	287	182
kW	220	220	220	209	132	200	200	200	190	120	234	234	234	222	140	242	242	242	230	146
TAL 046 F kVA	290	300	300	285	180	264	273	273	259	164	307	318	318	302	191	319	330	330	314	198
kW	232	240	240	228	144	211	218	218	207	131	246	254	254	242	153	255	264	264	251	158
TAL 046 G kVA	325	325	325	309	195	296	296	296	281	177	345	345	345	328	207	360	360	360	340	215
kW	260	260	260	247	156	237	237	237	225	142	276	276	276	262	166	288	288	288	272	172
TAL 046 H kVA	350	365	365	347	210	318	332	332	316	191	371	387	387	368	223	385	400	400	382	231
kW	280	292	292	278	168	254	266	266	253	153	297	310	310	294	178	308	320	320	306	185

(*) 12-wire option

Ratings 60 Hz - 1800 R.P.M.

kVA / kW - P.F. = 0.8

Duty / T° C	Continuous / 40 °C					Continuous / 40 °C					Stand-by / 40 °C					Stand-by / 27 °C				
Class / T° K	H / 125° K					F / 105° K					H / 150° K					H / 163° K				
Phase	3 ph.			1 ph.		3 ph.			1 ph.		3 ph.			1 ph.		3 ph.			1 ph.	
Y	380V	416V	440V	480V		380V	416V	440V	480V		380V	416V	440V	480V		380V	416V	440V	480V	
Δ	220V	240V		240V	220V	240V		240V	220V	240V		240V	220V	240V		240V	220V	240V		240V
YY (*)	208V			220V	240V	208V			220V	240V	208V			220V	240V	208V			220V	240V
ΔΔ (*)					240V					240V					240V					240V
TAL 046 C kVA	226	250	262	288	152	206	228	238	262	138	240	265	278	305	161	250	275	288	316	167
kW	181	200	210	230	122	165	182	190	210	110	192	212	222	244	129	200	220	230	253	134
TAL 046 D kVA	245	265	280	313	165	223	241	255	285	150	260	281	297	332	175	270	292	308	344	182
kW	196	212	224	250	132	178	193	204	228	120	208	225	238	266	140	216	234	246	275	146
TAL 046 E kVA	275	300	315	344	182	250	273	287	313	166	292	318	334	365	193	303	330	347	378	200
kW	220	240	252	275	146	200	218	230	250	133	234	254	267	292	154	242	264	278	302	160
TAL 046 F kVA	290	315	340	360	200	264	287	309	328	182	307	334	360	382	212	320	347	374	400	220
kW	232	252	272	288	160	211	230	247	262	146	246	267	288	306	170	256	278	299	320	176
TAL 046 G kVA	315	345	365	406	215	287	314	332	369	196	334	366	387	430	228	347	380	402	447	237
kW	252	276	292	325	172	230	251	266	295	157	267	293	310	344	182	278	304	322	358	190
TAL 046 H kVA	345	375	400	438	231	314	341	364	399	210	366	398	424	464	245	380	413	440	480	254
kW	276	300	320	350	185	251	273	291	319	168	293	318	339	371	196	304	330	352	384	203

(*) 12-wire option

Efficiencies 400 V - 50 Hz (— P.F.: 0.8) (..... P.F.: 1)

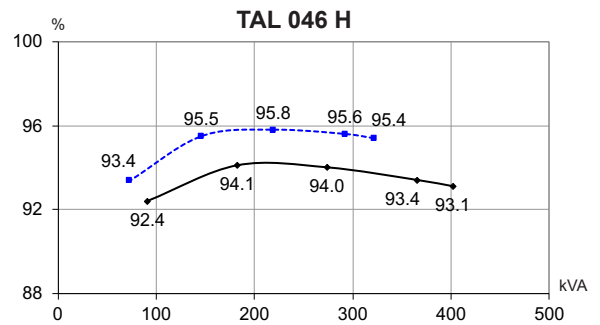
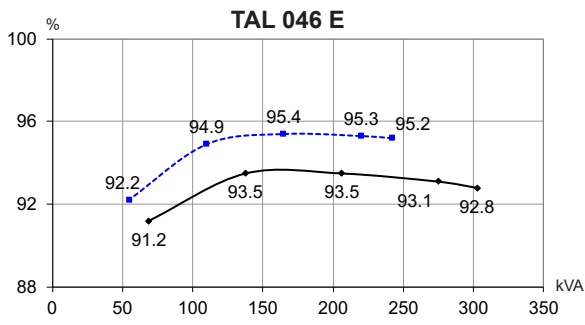
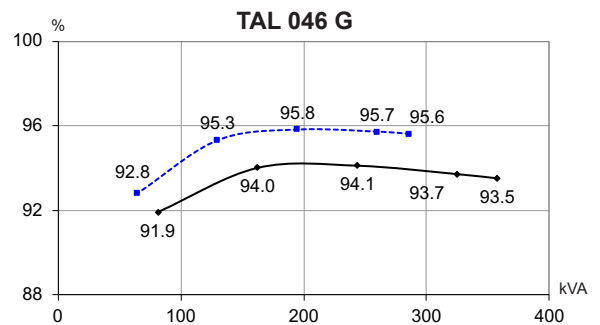
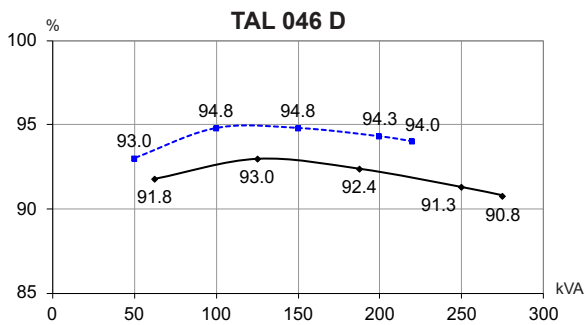
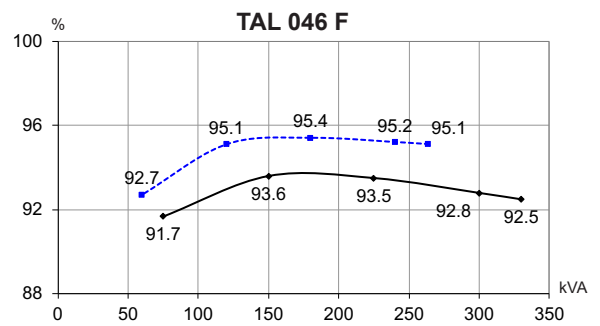
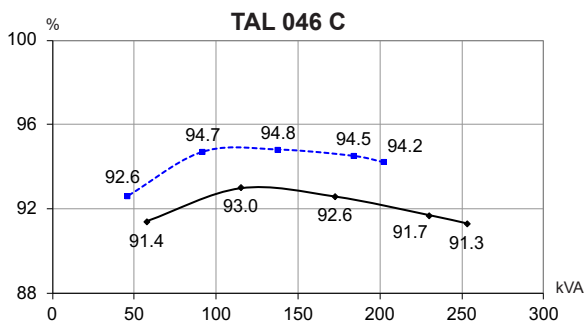

Reactances (%). Time constants (ms) - Class H / 400 V

	C	D	E	F	G	H
Kcc Short-circuit ratio	0.37	0.34	0.49	0.45	0.48	0.43
Xd Direct-axis synchronous reactance unsaturated	340	370	278	303	270	303
Xq Quadrature-axis synchronous reactance unsaturated	173	188	142	154	137	154
T'do No-load transient time constant	1983	1983	2049	2049	2093	2093
X'd Direct-axis transient reactance saturated	17.1	18.6	13.5	14.8	12.9	14.5
T'd Short-circuit transient time constant	100	100	100	100	100	100
X''d Direct-axis subtransient reactance saturated	13.7	14.9	10.8	11.8	10.3	11.6
T''d Subtransient time constant	10	10	10	10	10	10
X''q Quadrature-axis subtransient reactance saturated	17.4	18.9	13.5	14.7	12.6	14.2
Xo Zero sequence reactance	0.71	0.77	0.56	0.61	0.53	0.6
X2 Negative sequence reactance saturated	15.58	16.94	12.19	13.3	11.49	12.9
Ta Armature time constant	15	15	15	15	15	15

Other class H / 400 V data

io (A) No-load excitation current SHUNT/AREP+	1.01	1.01	1.14	1.14	1.06	1.06
ic (A) On-load excitation current SHUNT/AREP+	3.84	4.14	3.5	3.76	3.3	3.63
uc (V) On-load excitation voltage SHUNT/AREP+	37.4	40.2	40.6	43.5	38.2	41.9
ms Response time (ΔU = 20% transient)	500	500	500	500	500	500
kVA Start (ΔU = 20% cont. or ΔU = 30% trans.) SHUNT*	372	371	496	495	742	741
kVA Start (ΔU = 20% cont. or ΔU = 30% trans.) AREP+*	524	525	687	688	856	854
% Transient ΔU (on-load 4/4) SHUNT - P.F.: 0.8 _{LAG}	18	19.1	16.7	17.7	14.2	15.4
% Transient ΔU (on-load 4/4) AREP+ - P.F.: 0.8 _{LAG}	14.2	15	13.3	14.1	12.8	13.9
W No-load losses	3299	3299	4328	4328	4750	4750
W Heat dissipation	16579	18888	16242	18374	17367	20482

* P.F. = 0.6

Transient voltage variation 400 V - 50 Hz

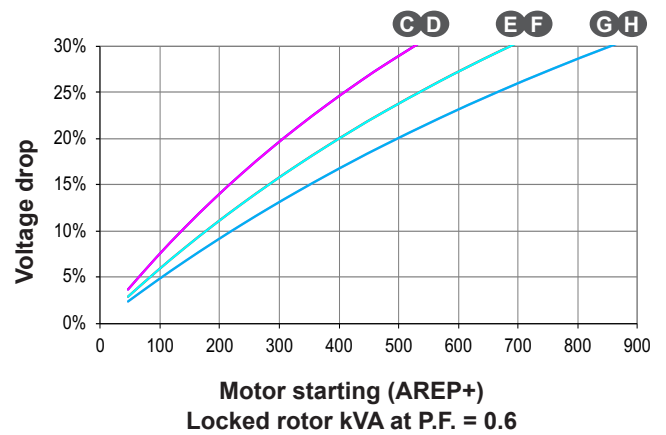
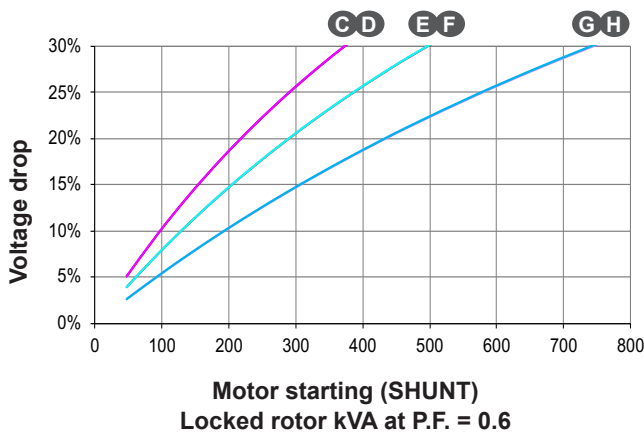
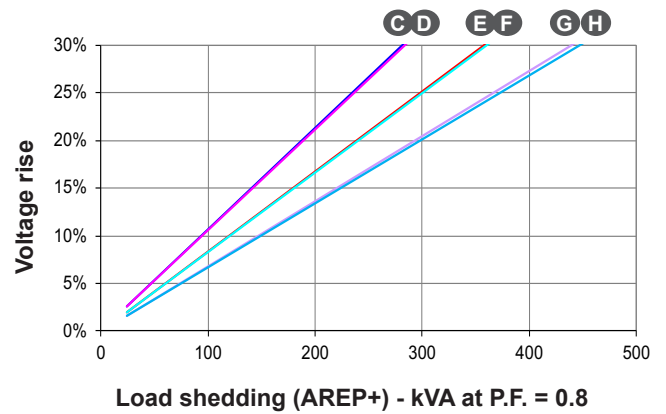
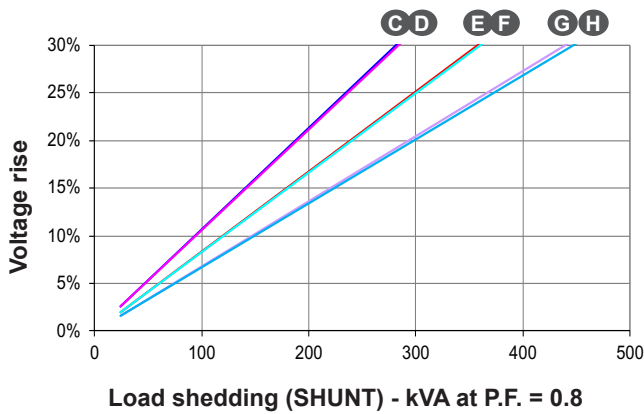
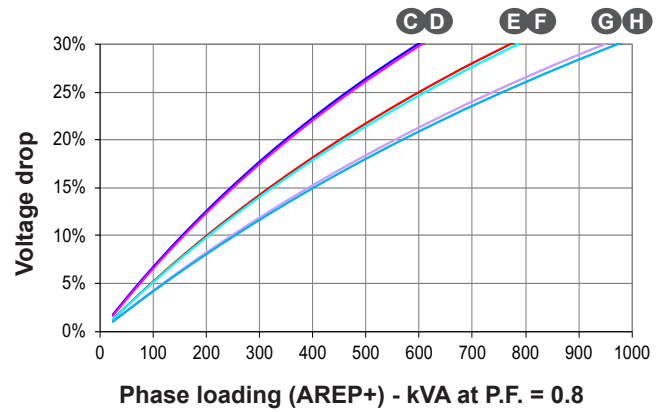
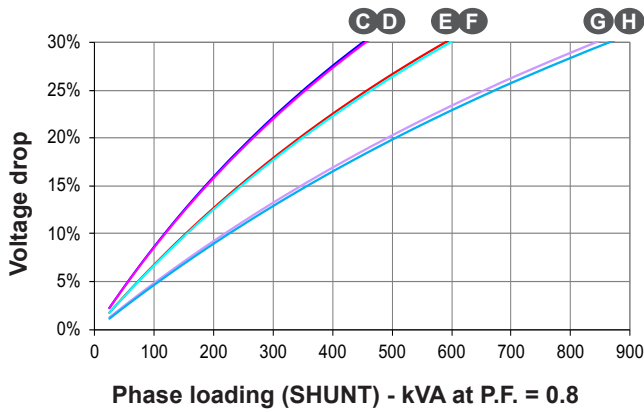

- For a starting P.F. other than 0.6, the starting kVA must be multiplied by $K = \text{Sine P.F.} / 0.8$
- For voltages other than 400V (Y), 230V (Δ) at 50 Hz, then kVA must be multiplied by $(400/U)^2$ or $(230/U)^2$.
- Transient performance of the PMG option, consult us.

Efficiencies 480 V - 60 Hz (— P.F.: 0.8) (----- P.F.: 1)

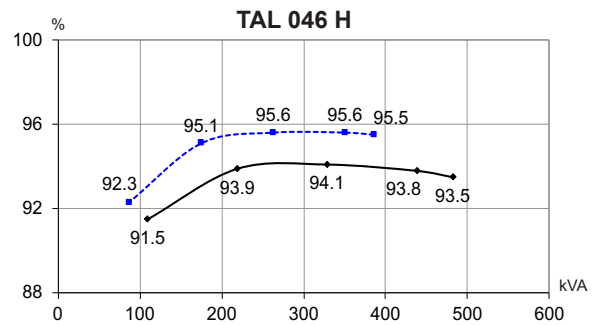
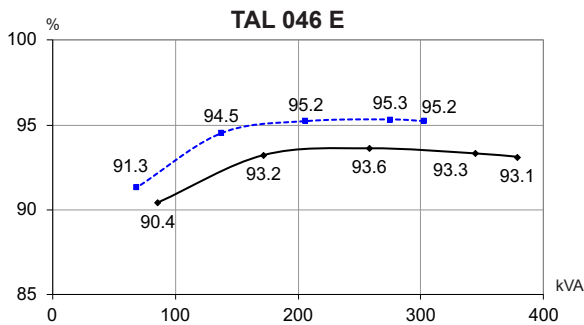
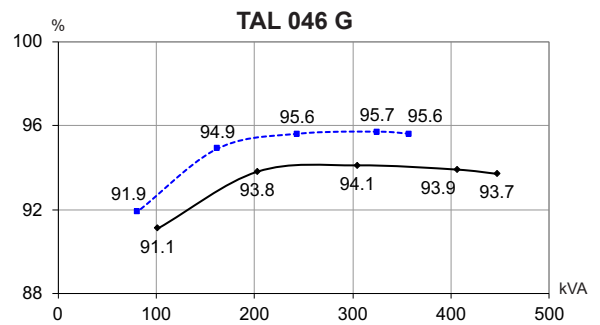
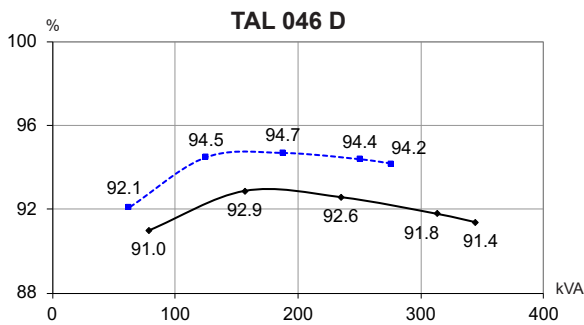
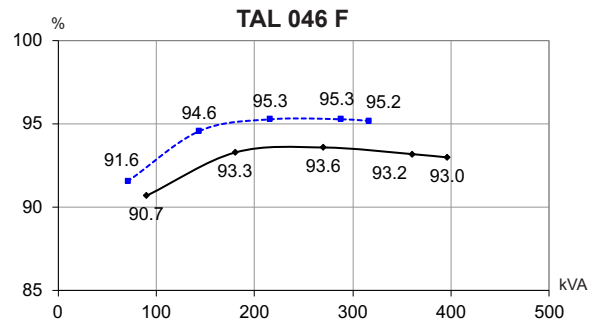
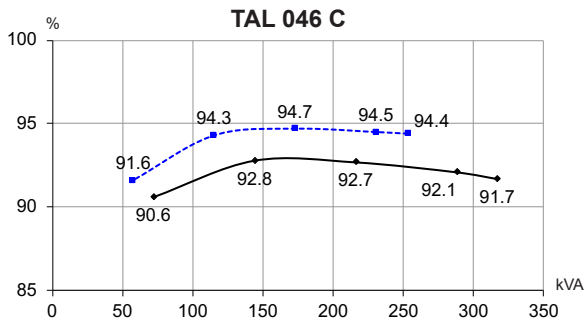

Reactances (%). Time constants (ms) - Class H / 480 V

	C	D	E	F	G	H
Kcc Short-circuit ratio	0.36	0.33	0.47	0.45	0.46	0.43
Xd Direct-axis synchronous reactance unsaturated	355	386	290	303	281	303
Xq Quadrature-axis synchronous reactance unsaturated	181	197	148	154	143	154
T'do No-load transient time constant	1983	1983	2049	2049	2093	2093
X'd Direct-axis transient reactance saturated	17.9	19.4	14.1	14.8	13.4	14.5
T'd Short-circuit transient time constant	100	100	100	100	100	100
X''d Direct-axis subtransient reactance saturated	14.3	15.5	11.3	11.8	10.7	11.6
T''d Subtransient time constant	10	10	10	10	10	10
X''q Quadrature-axis subtransient reactance saturated	18.1	19.7	14	14.7	13.1	14.2
Xo Zero sequence reactance	0.74	0.81	0.59	0.61	0.56	0.6
X2 Negative sequence reactance saturated	16.26	17.67	12.71	13.3	11.96	12.9
Ta Armature time constant	15	15	15	15	15	15

Other class H / 480 V data

io (A) No-load excitation current SHUNT/AREP+	1.01	1.01	1.14	1.14	1.06	1.06
ic (A) On-load excitation current SHUNT/AREP+	3.91	4.21	3.56	3.69	3.35	3.56
uc (V) On-load excitation voltage SHUNT/AREP+	38.3	41.1	41.5	43	38.9	41.3
ms Response time ($\Delta U = 20\%$ transient)	500	500	500	500	500	500
kVA Start ($\Delta U = 20\%$ cont. or $\Delta U = 30\%$ trans.) SHUNT*	446	448	594	593	888	889
kVA Start ($\Delta U = 20\%$ cont. or $\Delta U = 30\%$ trans.) AREP+*	627	629	828	826	1024	1025
% Transient ΔU (on-load 4/4) SHUNT - P.F.: 0.8 _{LAG}	18.5	19.6	17.2	17.7	14.6	15.4
% Transient ΔU (on-load 4/4) AREP+ - P.F.: 0.8 _{LAG}	14.6	15.5	13.7	14.1	13.2	13.9
W No-load losses	4960	4960	6365	6365	6978	6978
W Heat dissipation	19692	22264	19530	20731	20941	23137

* P.F. = 0.6

Transient voltage variation 480 V - 60 Hz

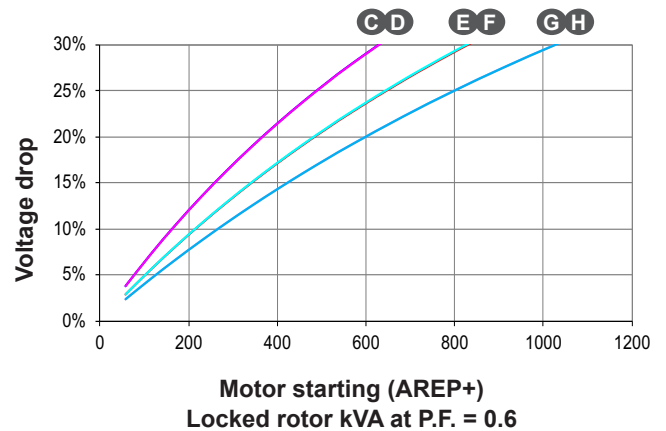
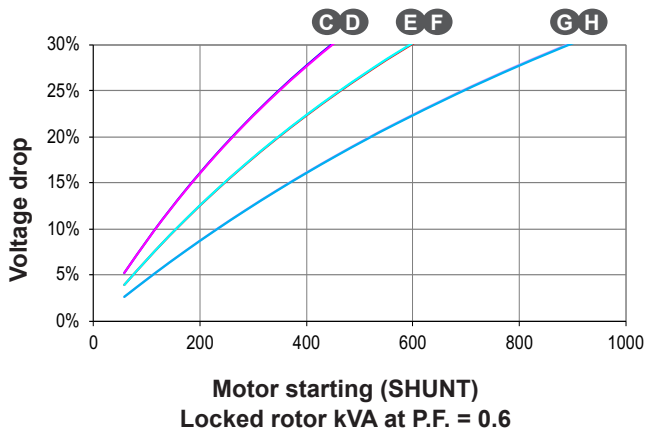
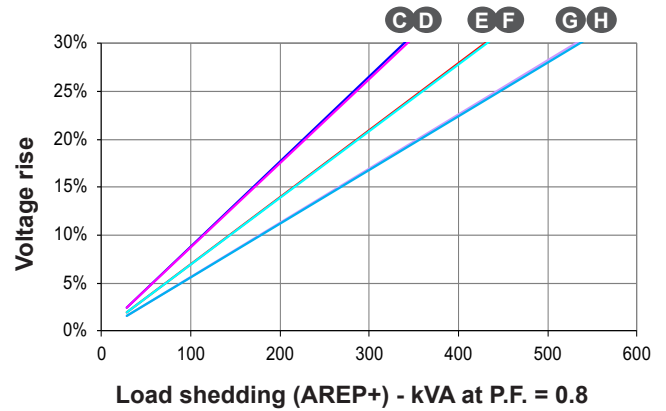
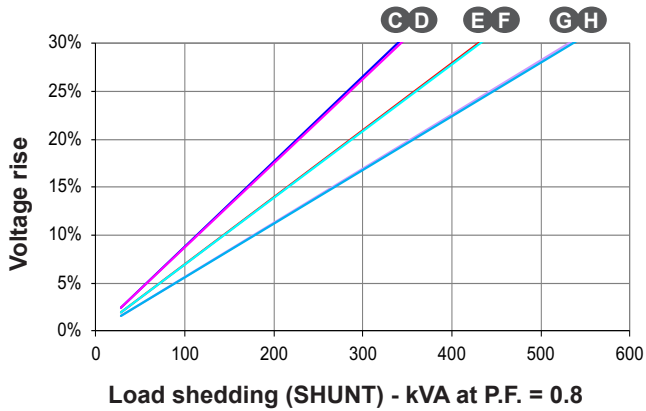
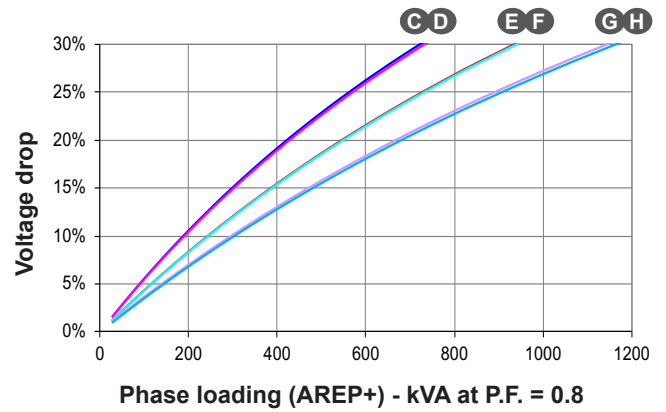
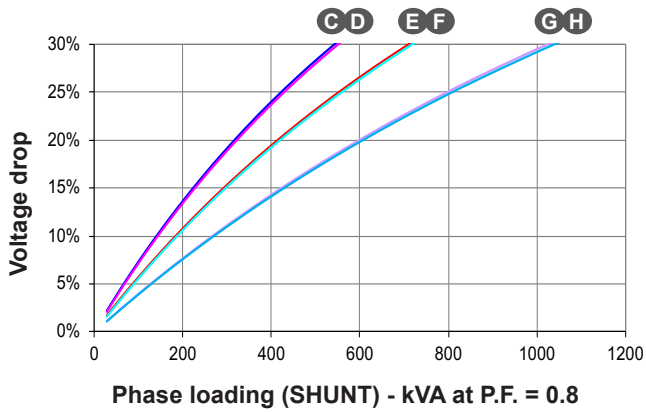

- For a starting P.F. other than 0.6, the starting kVA must be multiplied by $K = \text{Sine P.F.} / 0.8$
- For voltages other than 480V (Y), 277V (Δ), 240V (YY) at 60 Hz, then kVA must be multiplied by $(480/U)^2$ or $(277/U)^2$ or $(240/U)^2$.
- Transient performance of the PMG option, consult us.

3-phase short-circuit curves at no load and rated speed (star connection Y)

TAL 046 C

Symmetrical —
Asymmetrical - - -

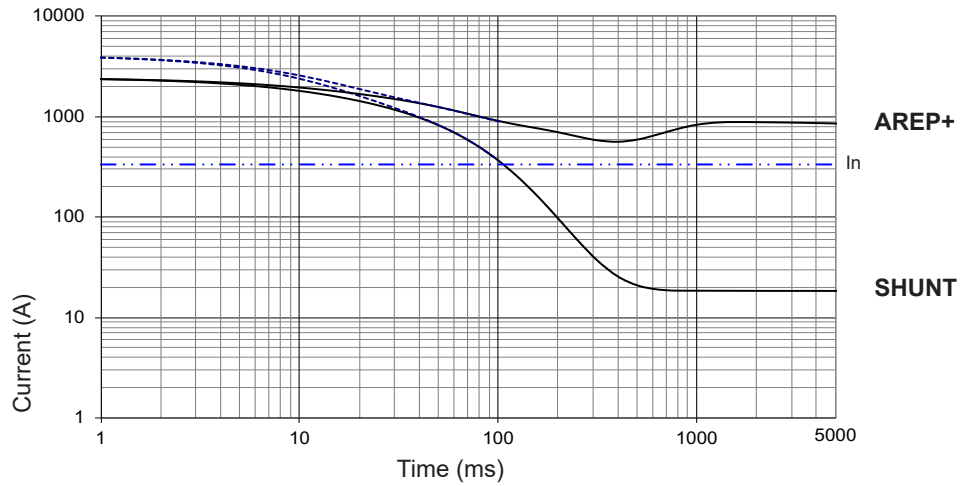

TAL 046 D

Symmetrical —
Asymmetrical - - -

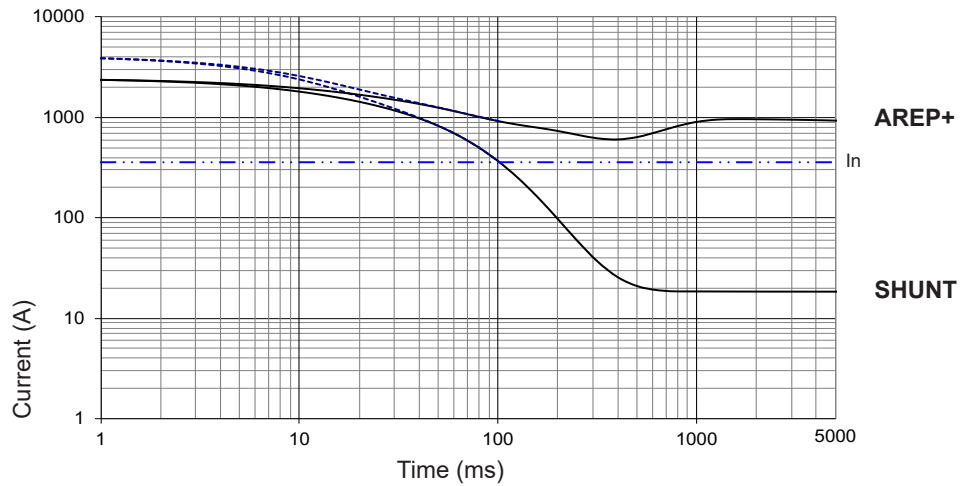

TAL 046 E

Symmetrical —
Asymmetrical - - -

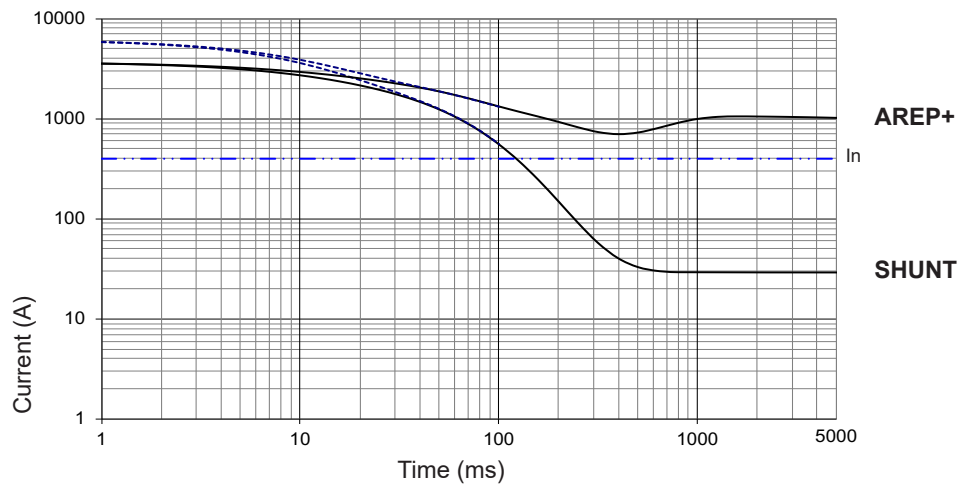

Influence due to connection

For (Δ) connection, use the following multiplication factor:
- Current value x 1.732.

3-phase short-circuit curves at no load and rated speed (star connection Y)

TAL 046 F

Symmetrical —
Asymmetrical - - -

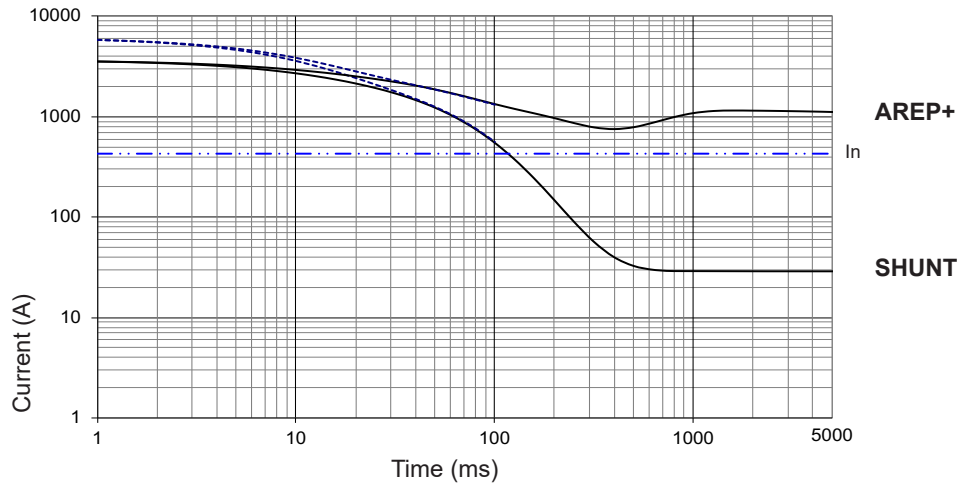

TAL 046 G

Symmetrical —
Asymmetrical - - -

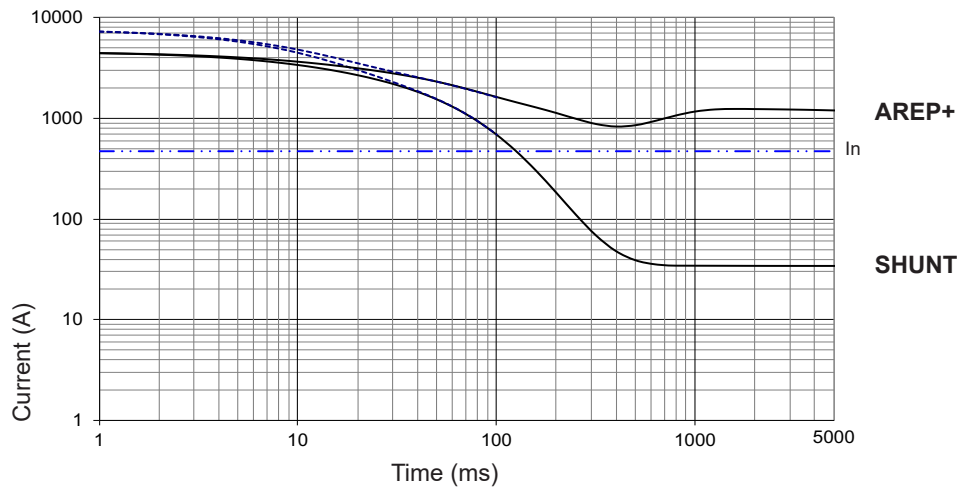

TAL 046 H

Symmetrical —
Asymmetrical - - -

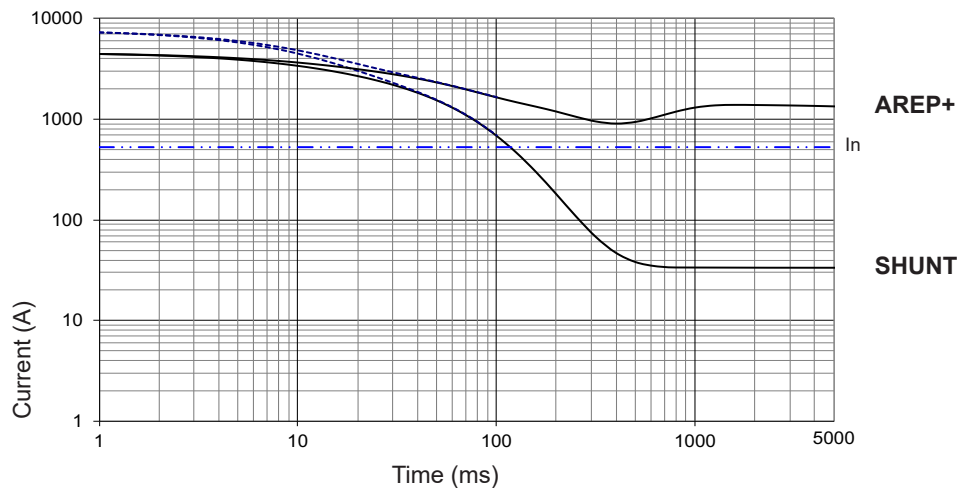

Influence due to short-circuit

Curves are based on a three-phase short-circuit.
For other types of short-circuit,
use the following multiplication factors.

	3 - phase	2 - phase L / L	1 - phase L / N
Instantaneous (max.)	1	0.87	1.3
Continuous	1	1.5	2.2
Maximum duration (AREP+/PMG)		1.5	

Single-bearing dimensions

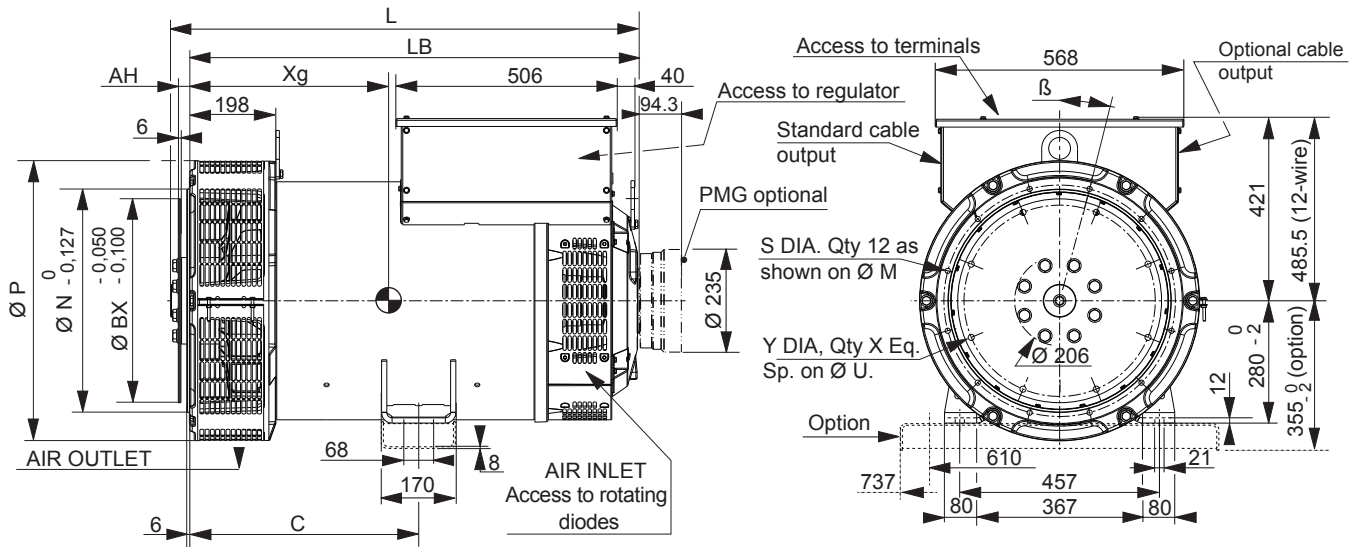

Dimensions (mm) and weight					
Type	L without PMG maxi*	LB	Xg	C	Weight (kg)
TAL 046 C	944	892	423	429	599
TAL 046 D	944	892	423	429	607
TAL 046 E	989	937	445	429	754
TAL 046 F	989	937	445	429	754
TAL 046 G**	1084	1032	493	525	888
TAL 046 H**	1084	1032	493	525	888

Coupling			
Flex plate	11 ½	14	18
Flange S.A.E 3	X		
Flange S.A.E 2	X		
Flange S.A.E 1	X	X	
Flange S.A.E ½		X	
Flange S.A.E 0		X	X

* L maxi = LB + AH maxi + 12.4 (only for SAE 11 ½) ** Shaft height = 355 mm optional

Flange (mm)					
S.A.E.	P	N	M	S	β °
3	600*/641	409.575	428.625	11	15°
2	600*/641	447.675	466.725	11	15°
1	600*/641	511.175	530.225	12	15°
½	713	584.2	619.125	14	15°
0	713	647.7	679.45	14	11° 15'

Flex plate (mm)					
S.A.E.	BX	U	X	Y	AH
11 ½	352.42	333.38	8	11	39.6
14	466.72	438.15	8	14	25.4
18*	571.5	542.92	6	17	15.7

* Option

* Specific dimension TAL 046 C

Torsional analysis data

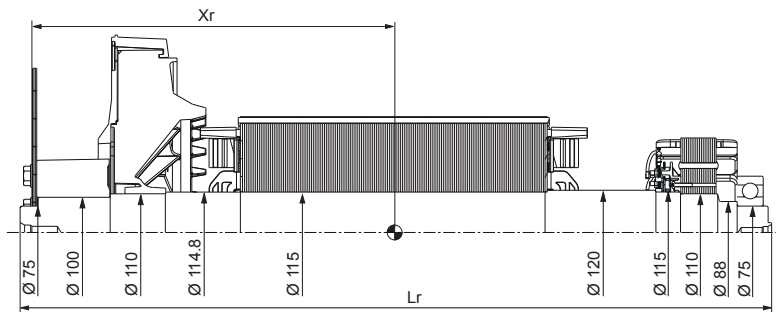

Centre of gravity: Xr (mm), Rotor length: Lr (mm), Weight: M (kg), Moment of inertia: J (kgm²): (4J = MD²)									
Flex plate	S.A.E. 11 ½				S.A.E. 14				
	Type	Xr	Lr	M	J	Xr	Lr	M	J
TAL 046 C		420	923	255	2.64	408	923	256	2.8
TAL 046 D		420	923	255	2.64	408	923	256	2.8
TAL 046 E		460	968	304	3.28	448	968	305	3.44
TAL 046 F		460	968	304	3.28	448	968	305	3.44
TAL 046 G		508	1063	358	3.97	497	1063	359	4.13
TAL 046 H		508	1063	358	3.97	497	1063	359	4.13

NOTE : Dimensions are for information only and may be subject to modifications. The torsional analysis of the transmission is imperative. All values are available upon request.

LEROY-SOMER[™]

www.leroy-somer.com/epg

[Linkedin.com/company/leroy-somer](https://www.linkedin.com/company/leroy-somer)
[Twitter.com/Leroy_Somer_en](https://twitter.com/Leroy_Somer_en)
[Facebook.com/LeroySomer.Nidec.en](https://www.facebook.com/LeroySomer.Nidec.en)
[YouTube.com/LeroySomerOfficiel](https://www.youtube.com/LeroySomerOfficiel)



Nidec
All for dreams

© Nidec 2020. The information contained in this brochure is for guidance only and does not form part of any contract. The accuracy cannot be guaranteed as Nidec have an ongoing process of development and reserve the right to change the specification of their products without notice.

Moteurs Leroy-Somer SAS. Siège : Bd Marcellin Leroy, CS 10015, 16915 Angoulême Cedex 9, France.
Capital social : 38 679 664 €, RCS Angoulême 338 567 258.