

STANDARD ACCESSORIES



DSE9470 MKII

24 Volt, 10 Amp Battery Charger



ADVANCED FEATURES

- UL recognised (9470-01 USA / 9470-A4 USA & Canada)
- Intelligent three and four stage charging profiles
- Configurable to suit 12V/24V - 5A/10A applications
- Adjustable current limit
- Can be used as a battery charger, power supply or both at the same time
- Automatic or manual boost and storage charge functions to help maintain battery condition
- Digital microprocessor technology
- Temperature compensation for battery charging
- Low output ripple and superb line regulation
- Three LED indicators
- Switched mode design
- Fully customisable battery charging curves
- Battery health check
- Battery voltage sensing
- Deep sleep mode
- PSU only mode
- Automatic voltage detection
- Wide output current range

Full Protection

- AC input under voltage
- AC input over voltage
- Battery charger output over voltage
- Battery charger output over current
- Battery under voltage alarm
- Automatic battery detection
- Automatic battery charger self test
- Output short circuit and inversion polarity with auto recovery
- Max current mode
- SCADA digital input status information
- Automatic power de-rating at high ambient temperatures.
- Optional battery temperature compensation using PT1000 temperature sensor with over temperature protection

Automatic Boost Mode

- Boosts and equalises cell charge, improving battery performance

Power Save Mode

- Once the battery is fully charged, the chargers switch to eco-power to save energy

Communication

- Can be integrated into external systems through MODBUS RTU using RS485

- Fully configurable via DSE Configuration Suite PC Software
- External remote display option - DSE2541

KEY BENEFITS

- Fully flexible to maximise the life of the battery
- Suitable for a wide range of battery types
- Minimum 86% efficiency throughout full operating range
- No external intervention for boost mode
- Multiple chargers can be linked together to provide larger current outputs
- Can be permanently connected to a battery and AC supply. No need to disconnect through high load conditions such as cranking or when the engine is running.

SPECIFICATIONS

AC SUPPLY

VOLTAGE RANGE
90 V to 305 V (L to N)

FREQUENCY RANGE
48 Hz to 64 Hz (L to N)

DC OUTPUT

10 A DC at 24 V DC (Configurable)

RIPPLE AND NOISE
<1%

EFFICIENCY
>86%

REGULATION LINE
<0.5%

LOAD
2%

TEMPERATURE SENSOR INPUT
PT1000

PROTECTIONS

Short circuit
DC over voltage
DC over current
Reverse polarity
Over temperature
AC under & over voltage

CHARGE FAILURE RELAY
3 A at 30 V DC volt free relay

DIMENSIONS

OVERALL
70 mm x 200 mm x 130 mm
2.7" x 7.9" x 5.1"

WEIGHT
0.75 kg

OPERATING TEMPERATURE RANGE

-30 °C to +70 °C
-22 °F to +158 °F

STORAGE TEMPERATURE RANGE

-30 °C to +70 °C
-22 °F to +158 °F

UL VOLTAGE APPROVAL RATINGS

USA ONLY (9470-01)
110 V - 250 V
USA & CANADA (9470-A4)
110 V - 150 V

RELATED MATERIALS

TITLE

DSE9400 Series Configuration Suite PC Software Manual
DSE Configuration Suite Installation & Operators Manual
DSE9000 Series Installation Instructions
DSE9000 Series Operators Manual

PART NO.

057-159
057-151
053-049
057-085

DEEP SEA ELECTRONICS LTD UK

Highfield House, Hunmanby Industrial Estate, Hunmanby YO14 0PH
TELEPHONE +44 (0) 1723 890099

EMAIL sales@deepseaelectronics.com **WEBSITE** www.deepseaelectronics.com

DEEP SEA ELECTRONICS INC USA

3230 Williams Avenue, Rockford, IL 61101-2668 USA
TELEPHONE +1 (815) 316 8706 **FACSIMILE** +1 (815) 316 8708

EMAIL usasales@deepseaelectronics.com **WEBSITE** www.deepseaelectronics.com

DSE9470 MKII

24 Volt, 10 Amp Battery Charger

The DSE9470 MKII is a UL recognised intelligent battery charger fully configurable for 12 Volt/ 24 Volt & 5 Amp / 10 Amp applications.

There are two different UL recognised variants. The 9470-01 is recognised for USA only (110 V - 250 V) and the 9470-A4 is recognised for USA & Canada (110 V - 150 V).

The charger features automatic voltage detection and battery voltage sensing down to 1 volt and has an output current range that can go down to 1 amp. The charger can be easily programmed for different charging curves, to maximise battery life.

The charger can be DIN rail or chassis mounted, using the fixing holes that are built into the case. The charger includes three coloured LEDs to indicate charging status and fault conditions.

The chargers do not include any moving parts for additional durability and reliability. Each charger will continue to operate during engine running.

Multiple chargers can be linked together to provide a larger current output where required.

The battery chargers are programmed using the user-friendly DSE Configuration Suite PC software.

PART NUMBERS

9470-01
24 V 10 A Battery Charger
(110 V - 250 V UL Recognised - USA)

9470-A4
24 V 10 A Battery Charger
(110 V - 150 V UL Recognised - USA & Canada)

ENVIRONMENTAL TESTING STANDARDS

ELECTRO-MAGNETIC COMPATIBILITY

BS EN 61000-6-2
EMC Generic Immunity Standard for the Industrial Environment
BS EN 61000-6-4
EMC Generic Emission Standard for the Industrial Environment

OPERATING TEMPERATURE RANGE

BS EN 60068-2-1
Ab/Ae Cold Test -30 °C
BS EN 60068-2-2
Bb/Be Dry Heat +80 °C
* Refer to de-rating curve in the DSE9000 Operator Manual

VIBRATION

BS EN 60068-2-6
Ten sweeps in each of three major axes
5 Hz to 8 Hz @ +/-7.5 mm,
8 Hz to 500 Hz @ 2 gn

HUMIDITY

BS EN 60068-2-30
Db Damp Heat Cyclic 20/55 oC
@ 95% RH 48 Hours
BS EN 60068-2-78
Cab Damp Heat Static 40 oC
@ 93% RH 48 Hours

SHOCK

BS EN 60068-2-27
Three shocks in each of three major axes
15 gn in 11 ms

COMPREHENSIVE FEATURE LIST TO SUIT A WIDE VARIETY OF BATTERY CHARGER APPLICATIONS

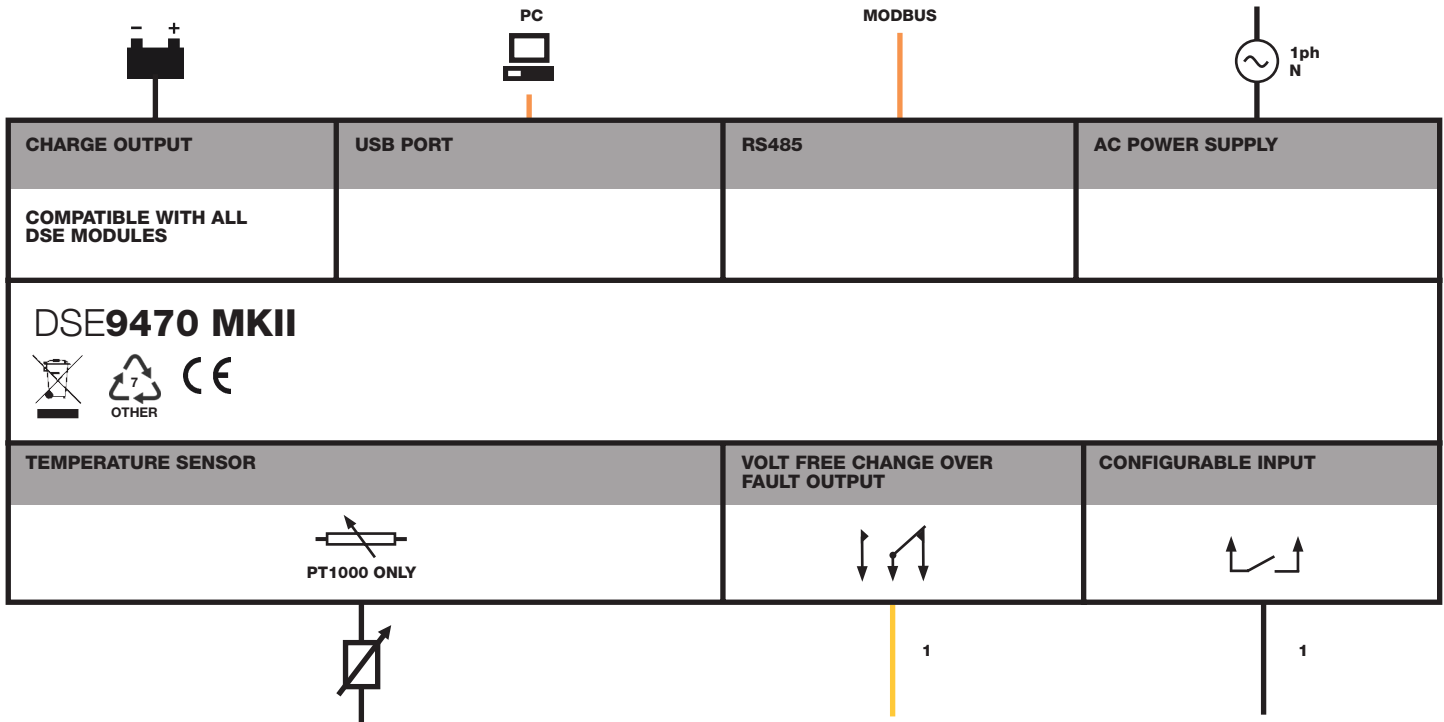

Thermosiphon Heating Systems

TPS



Hotstart's TPS thermosiphon heating system is a coolant preheater, developed to maintain optimal temperatures for diesel and gas engines in stationary land power, marine, construction equipment, and truck applications.



PROVEN DESIGN

Depend on consistent, reliable heating with the proven design of the TPS thermosiphon heater. Heated coolant rises through the engine block, maintaining critical fluid temperatures for easy engine starts when needed.



EASY INSTALLATION

The TPS's inlet and outlet positions allow for quick and simple installations, reducing complicated plumbing requirements. Each heater comes with a mounting kit for optimized installations.



VERSATILE & ADAPTABLE

The TPS can be configured for almost any weather-protected application. Multiple options and voltages are available, including UL/C-US listed and CE-compliant models.

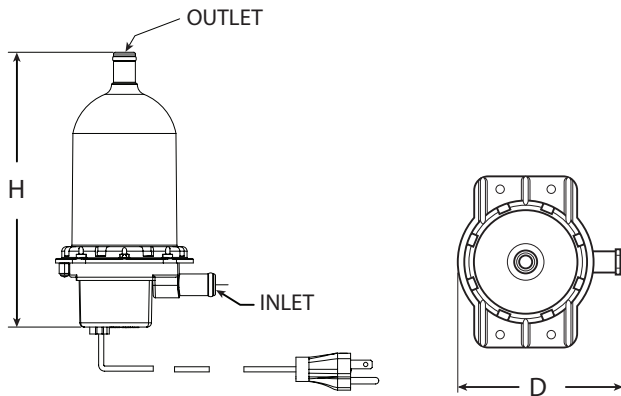

| Height (H) | Depth (D) | Weight |
|------------|-----------|--------|
| 7.9" | 4.6" | 1.7 lb |
| 200 mm | 117 mm | 771 g |

| TPS System | |
|--------------------------|------------------------------|
| Phase | single-phase (1 Ø) |
| Voltage | 120V 240V 277V |
| Ingress | IP41 |
| Tank Material | Polyphenylene Sulfide (PPS) |
| Heating Element Material | Incoloy 800 |
| Min./Max. Ambient Temp | -40–40 °C (-40–104 °F) |
| Certification | UL/C-US-listed, CE-compliant |

| TPS Coolant | |
|---------------|--|
| Fluid Type | Water Coolant mix (50% water/50% glycol) |
| Heat Power* | 0.5 kW 1 kW 1.5 kW 1.8 kW 2 kW |
| Temp. Control | Fixed, 100–120 °F (38–49 °C) |
| Max. Pressure | 90 psi (620 kPa) |
| Inlet/Outlet | 0.625" hose barb (15.9 mm) |

| Temperature Range | | Numerical Code |
|-------------------|----------------|----------------|
| ON | OFF | Code |
| 80 °F (27 °C) | 100 °F (38 °C) | 8 |
| 100 °F (38 °C) | 120 °F (49 °C) | 10 |
| 120 °F (49 °C) | 140 °F (60 °C) | 12 |

Options shown represent typical tested or certified configurations. Additional options or configurations may be available. For assistance with your heating system application, contact Hotstart at 509.536.8660 or sales@hotstart.com.

*2 kW available in 240 V only, 1.8 kW available in 120 V only.

Ordering Information

TPS

| Engine Displacement | Power Supply | | | Heating System | | |
|---------------------------|--------------|---|----|----------------|------|----------------|
| | V | Ø | Hz | kW | A | Model Number |
| 150 CID 2.5 L | 120 | 1 | 60 | 0.5 | 4.2 | TPS051GT8-000 |
| | 120 | 1 | 60 | 0.5 | 4.2 | TPS051GT10-000 |
| | 120 | 1 | 60 | 0.5 | 4.2 | TPS051GT12-000 |
| | 240 | 1 | 60 | 0.5 | 2.1 | TPS052GT8-000 |
| | 240 | 1 | 60 | 0.5 | 2.1 | TPS052GT10-000 |
| | 240 | 1 | 60 | 0.5 | 2.1 | TPS052GT10-013 |
| | 240 | 1 | 60 | 0.5 | 2.1 | TPS052GT12-000 |
| 350 CID 5.7 L | 120 | 1 | 60 | 1 | 8.4 | TPS101GT8-000 |
| | 120 | 1 | 60 | 1 | 8.4 | TPS101GT10-000 |
| | 120 | 1 | 60 | 1 | 8.4 | TPS101GT12-000 |
| | 240 | 1 | 60 | 1 | 4.2 | TPS102GT8-000 |
| | 240 | 1 | 60 | 1 | 4.2 | TPS102GT10-000 |
| | 240 | 1 | 60 | 1 | 4.2 | TPS102GT10-013 |
| | 240 | 1 | 60 | 1 | 4.2 | TPS102GT12-000 |
| 350–500 CID 5.7–8.2 L | 120 | 1 | 60 | 1.5 | 12.5 | TPS151GT8-000 |
| | 120 | 1 | 60 | 1.5 | 12.5 | TPS151GT10-000 |
| | 120 | 1 | 60 | 1.5 | 12.5 | TPS151GT12-000 |
| | 240 | 1 | 60 | 1.5 | 6.3 | TPS152GT8-000 |
| | 240 | 1 | 60 | 1.5 | 6.3 | TPS152GT10-000 |
| | 240 | 1 | 60 | 1.5 | 6.3 | TPS152GT10-013 |
| | 240 | 1 | 60 | 1.5 | 6.3 | TPS152GT12-000 |
| 500–700 CID 8.2–11.5 L | 120 | 1 | 60 | 1.8 | 15 | TPS181GT8-000 |
| | 120 | 1 | 60 | 1.8 | 15 | TPS181GT10-000 |
| | 120 | 1 | 60 | 1.8 | 15 | TPS181GT12-000 |
| | 240 | 1 | 60 | 2 | 8.3 | TPS202GT8-000 |
| | 240 | 1 | 60 | 2 | 8.3 | TPS202GT10-000 |
| | 240 | 1 | 60 | 2 | 8.3 | TPS202GT10-013 |
| | 240 | 1 | 60 | 2 | 8.3 | TPS202GT12-000 |

Power cord length on all models – 48" (1219 mm). Part numbers ending in -013 feature 2 meter round cord & Schuko plug - CE compliant

TPS engine preheaters include a fixed setting thermostat. A single or double digit numeral at the end of the model number prefix designates the temperature range. Example: TPS101GT10-000

TPS heaters are available with in-line adjustable and remote thread-in fixed thermostat. Please reference Hotstart's product catalog for part numbers.



D350 DIGITAL AVR FOR ALTERNATORS WITH SHUNT, AREP OR PMG EXCITATION

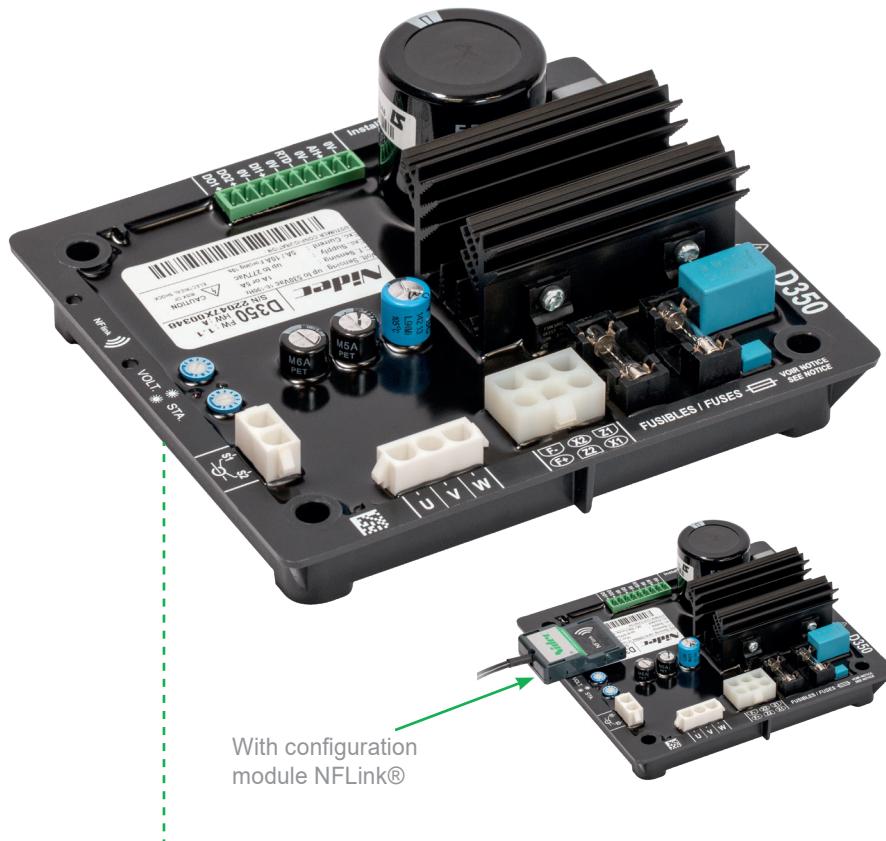

With configuration module NFLink®

KEY FEATURES

- Rated excitation current: 5 A
- Maximum excitation current: 10 A for 10 s
- Voltage regulation accuracy: $\pm 0.25\%$
- Excitation: SHUNT, AREP or PMG
- Voltage sensing: three-phase or single-phase - 530 VAC max.
- CT input: yes (1 A and 5 A)
- Mate-N-Lok connectors
- Quadrature droop function
- Over-excitation protection
- Loss of sensing
- Stator current monitoring
- U/F function
- LAM function
- Soft Start function
- Voltage soft recovery
- Two configuration modes can be activated by a digital input (eg. 50/60 Hz)
- Event logger

The D350 is a digital automatic voltage regulator (AVR) for alternators which require rated field current up to 5 A.

It offers numerous control and protection functions for the various components of generator sets, especially for managing short-circuits and load impacts.

The D350 can be configured using the Nidec Leroy-Somer EasyReg Advanced software.

For easier maintenance and investigations in the event of problems, the D350 also offers an event logger function and an NFLink® wireless communication module for setting parameters and retrieving data.

The D350 conforms to standard IEC 60034-1 and is certified UL508 and CSA.

CONNECTIONS AND COMMUNICATION

- Inputs:
 - 1 x analog input
 - 1 x digital input
 - 1 x thermal sensor input (configurable in PT100 or PTC)
- Outputs:
 - 2 x digital outputs
- Event logger
- NFLink® module for configuration
- Mate-N-Lok connectors

OPERATION CONDITIONS

- Operating temperature range: -40°C to +65°C
- Storage temperature range: -55°C to +85°C
- Hygrometry: up to 98%
- Maximum impact: 9 g on 3 axis

OPERATION RANGE

| | LSA 40 | LSA 42.3 | LSA 44.3 | LSA 46.3 | LSA 47.3 | LSA 49.3 | LSA 50.2 |
|-------|-----------|-----------|----------|----------|----------|----------|----------|
| SHUNT | ✓ | ✓ | ✓ | ✓ | ✓ | ✓ | ✓ |
| AREP | ✓ | ✓ | ✓ | ✓ | ✓ | ✓ | ✓ |
| PMG | - | ✓ | ✓ | ✓ | ✓ | ✓ | ✓ |
| | TAL 040 | TAL 042 | TAL 044 | TAL 046 | TAL 0473 | TAL 049 | |
| SHUNT | ✓ | ✓ | ✓ | ✓ | ✓ | ✓ | |
| AREP+ | ✓ | ✓ | ✓ | ✓ | ✓ | ✓ | |
| PMG | - | ✓ | ✓ | ✓ | ✓ | ✓ | |
| | LSAH 42.3 | LSAH 44.3 | | | | | |
| AREP | ✓ | ✓ | | | | | |

DIMENSIONS

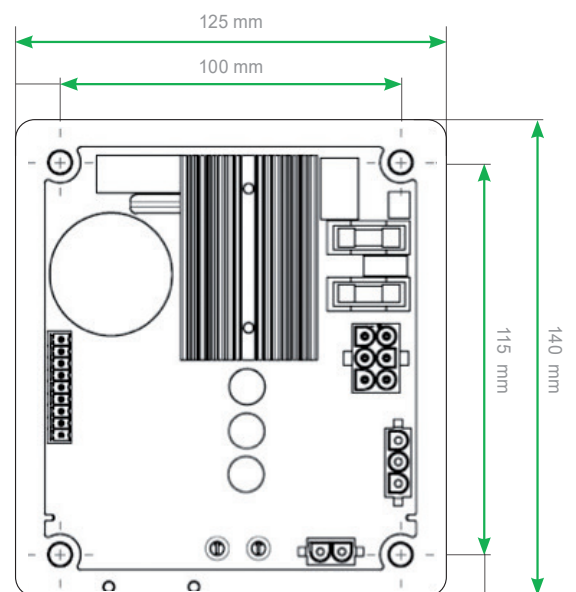
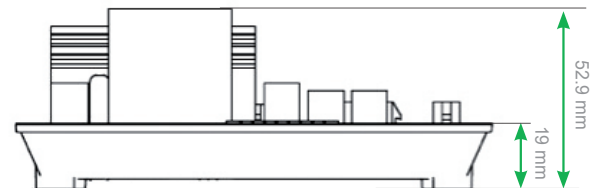
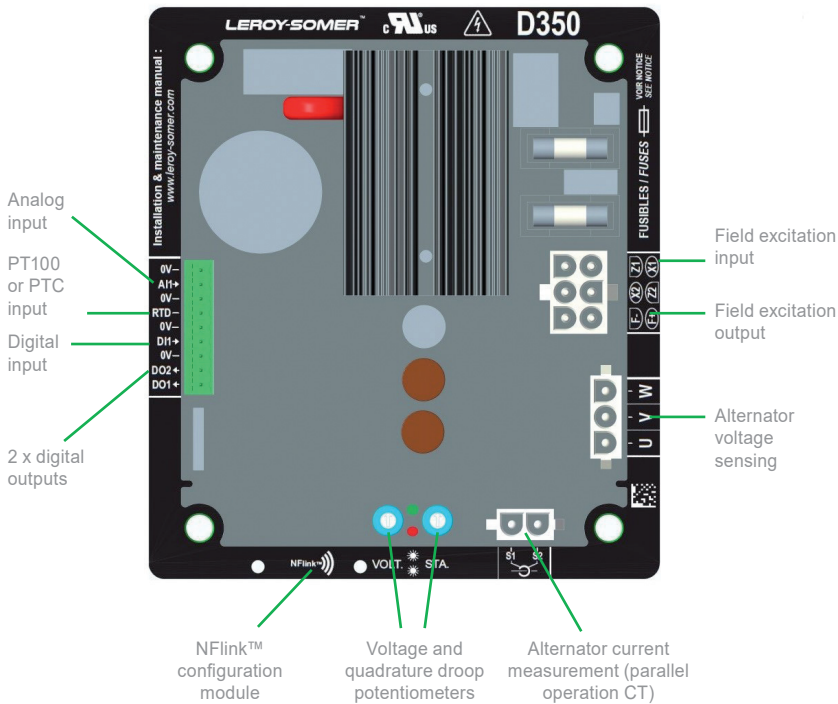

SYSTEM BATTERIES



TEKSAN gensets equipped with fully closed, maintenance-free lead acid batteries.

TEKSAN selects batteries according to engine manufacturer's recommendation and to comply NFPA requirements.



| Genset Model | BATTERY | | | Genset Model | BATTERY | | |
|----------------|-------------|----------------|-------------|--------------|---------|----------|------|
| | CCA | Size | Type | | CCA | Size | Type |
| TJUD9P | 350A | (1)47Ah | NS60 | TJUD250P | 860A | (2)102Ah | L5 |
| TJUD13P | 350A | (1)47Ah | NS60 | TJUD275P | 860A | (2)102Ah | L5 |
| TJUD20P | 700A | (1)75Ah | LB3 | TJUD300P | 860A | (2)102Ah | L5 |
| TJUD25P | 700A | (1)75Ah | LB3 | TJUD315P | 860A | (2)102Ah | L5 |
| TJUD28P | 700A | (1)75Ah | LB3 | TJUD350P | 860A | (2)102Ah | L5 |
| TJUD30P | 700A | (1)75Ah | LB3 | TJUD400P | 860A | (2)102Ah | L5 |
| TJUD50P | 700A | (1)75Ah | LB3 | TJUD450P | 860A | (2)102Ah | L5 |
| TJUD55P | 700A | (1)75Ah | LB3 | TJUD500P | 860A | (2)102Ah | L5 |
| TJUD60P | 700A | (1)75Ah | LB3 | TJUD530P | 860A | (2)102Ah | L5 |
| TJUD65P | 700A | (1)75Ah | LB3 | TJUD550P | 860A | (2)102Ah | L5 |
| TJUD80P | 700A | (1)75Ah | LB3 | TJUD600P | (2)860A | (4)102Ah | L5 |
| TJUD100P | 700A | (1)75Ah | LB3 | TJUD750P | (2)860A | (4)102Ah | L5 |
| TJUD125P | 860A | (1)102Ah | L5 | TJUD800P | (2)860A | (4)102Ah | L5 |
| TJUD150P | 860A | (1)102Ah | L5 | TJUD865P | (2)860A | (4)102Ah | L5 |
| TJUD160P | 860A | (1)102Ah | L5 | TJUD900P | (2)860A | (4)102Ah | L5 |
| TJUD175P | 860A | (1)102Ah | L5 | TJUD1000P | (2)860A | (4)102Ah | L5 |
| TJUD180P | 860A | (1)102Ah | L5 | | | | |
| TJUD200P | 860A | (1)102Ah | L5 | | | | |
| | | | | | | | |
| TJUD300H | 860A | (2)102Ah | L5 | TJUD750H | (2)860A | (4)102Ah | L5 |
| TJUD325H | 860A | (2)102Ah | L5 | TJUD800H | (2)860A | (4)102Ah | L5 |
| TJUD350H | 860A | (2)102Ah | L5 | TJUD900H | (2)860A | (4)102Ah | L5 |
| TJUD400H | 860A | (2)102Ah | L5 | | | | |
| | | | | | | | |
| TJUD800B | (2)860A | (4)102Ah | L5 | TJUD1000B | (2)860A | (4)102Ah | L5 |
| TJUD900B | (2)860A | (4)102Ah | L5 | TJUD1250B | (2)860A | (4)102Ah | L5 |





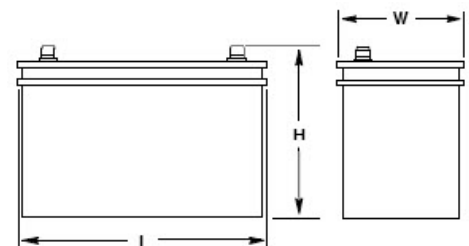

| Genset Model | BATTERY | | | Genset Model | BATTERY | | |
|--------------|---------|----------|------|--------------|---------|----------|------|
| | CCA | Size | Type | | CCA | Size | Type |
| TJUG25PS | 700A | (1)75Ah | LB3 | TJUG200PS | 860A | (2)102Ah | L5 |
| TJUG40PS | 700A | (1)75Ah | LB3 | TJUG200PD | 860A | (2)102Ah | L5 |
| TJUG60PS | 700A | (1)75Ah | LB3 | TJUG250PS | 860A | (2)102Ah | L5 |
| TJUG80PS | 700A | (1)75Ah | LB3 | TJUG275PD | 860A | (2)102Ah | L5 |
| TJUG100PS | 700A | (1)75Ah | LB3 | TJUG300PD | 860A | (2)102Ah | L5 |
| TJUG115PS | 860A | (1)102Ah | L5 | TJUG350PD | 860A | (2)102Ah | L5 |
| TJUG125PS | 860A | (1)102Ah | L5 | TJUG400PD | 860A | (2)102Ah | L5 |
| TJUG150PS | 860A | (1)102Ah | L5 | TJUG450PD | 860A | (2)102Ah | L5 |
| TJUG200PN | 860A | (1)102Ah | L5 | TJUG500PD | 860A | (2)102Ah | L5 |

| BATTERY DIMENSIONS | | | |
|--------------------|---------------|--------------|--------------|
| Type | L | W | H |
| NS60 | 238mm / 9.4" | 129mm / 5.1" | 224mm / 8.8" |
| LB3 | 278mm / 11" | 175mm / 6.9" | 175mm / 6.9" |
| L5 | 352mm / 13.9" | 175mm / 6.9" | 190mm / 7.5" |



Attention: Batteries must always be kept under a buffer charge. Batteries on a genset that is stored for a long period of time, must be re-charged to prevent corruption on battery plates and become out of use.

| | | | | |
|---|-----------------------|--|---------------------|--|
| BATTERY TECHNICAL DATA SHEET | | Date: 24/05/2013 | | |
| | | Number: 1 | | |
| Customer: TEKSAN | | Type: NS60 | | |
| INCI Reference: 1007015 | | 12 V 47 AH 380A (EN) | | |
| Dimensions: 238*129*224 (L*W*TH) | |  | | |
| CONTAINER | Box | Color: | GREY | |
| | | Hold Down: | B0 | |
| | | Material: | PP | |
| Lid | | Type: | SEALED | |
| | | Polarity: | 0 | |
| | | Color: | GREY | |
| | | Material: | PP | |
| Plug | | Type: | 6x1 Plug set | |
| | | Color: | GREY | |
| | | Material: | PP | |
| CELL | Plate number per cell | Positive: | 05 | |
| | | Negatives: | 05 | |
| | Plate dimensions | Height x Length: | 125x144 mm | |
| | | Positive thickness: | 1.90mm | |
| | | Negative thickness: | 1.51mm | |
| Grid Alloy | Positives: | PbSb | | |
| | Negatives: | PbCa | | |
| Separator | Type: | PE | | |
| | Thickness: | 0.8 mm | | |
| | Enveloped plate: | Negative | | |
| Plate Blocking | Hot Melt on top: | NO | | |
| MASS | Total Battery: | 11,58 | kg (MAX) | |

| | | |
|---|--------------------|---|
|  | |  |
| B200E | | |
| Product | | Control Unit |
| Model | | Emergency |
| Type | | Turn to Release |
| Contact | | 1NC |
| Color | | Red |
| Dia | | 22 mm |
| Head Dia | | 40 mm |
| Current | Ie | 4 A (250V AC) |
| Usage Category | | AC 15 |
| Mechanical Life | Min Qty | 500000 |
| Electrical Life | Min Qty | 100000 |
| Operating Frequency | On-Off/Hour | Mech. 1200 Elec. 1200 |
| Insulation Voltage | Ui | 300V |
| Impulse Withstand Voltage | Uimp | 2.5 kV |
| Dielectric Strength (Body-Contact) | | 2.500V AC |
| Dielectric Strength (Contact-Contact) | | 1.500V AC |
| Isolation Resistance | | 10 MΩ min. (500V DC) |
| Operating Temperature | | -15 / + 80 °C |
| Pollution Degree | | 3 |
| Protection Degree | | IP50 |
| Contact Material | | AgNi |
| Cable Section | | 1.5-2.5 mm ² |
| Screw Torque | | 1,5 Nm |
| Short Circuit Breaking Capacity | Ics | 1 kA |
| Production Time | | 31.12.1899 00:00:00 |
| Serial | | B Series Plastic |
| Specifications | | Non-flammable V0 PA6.6 contact blocks |
| | | Various illumination contact blocks availability |
| | | Variety of products for all areas of application |
| Standards / Certificates | | IEC 60947-5-1 TS EN 60947-5-1 UL 508 VDE 0660 |
|     | | |