

*ALTERNATOR DATASHEET*

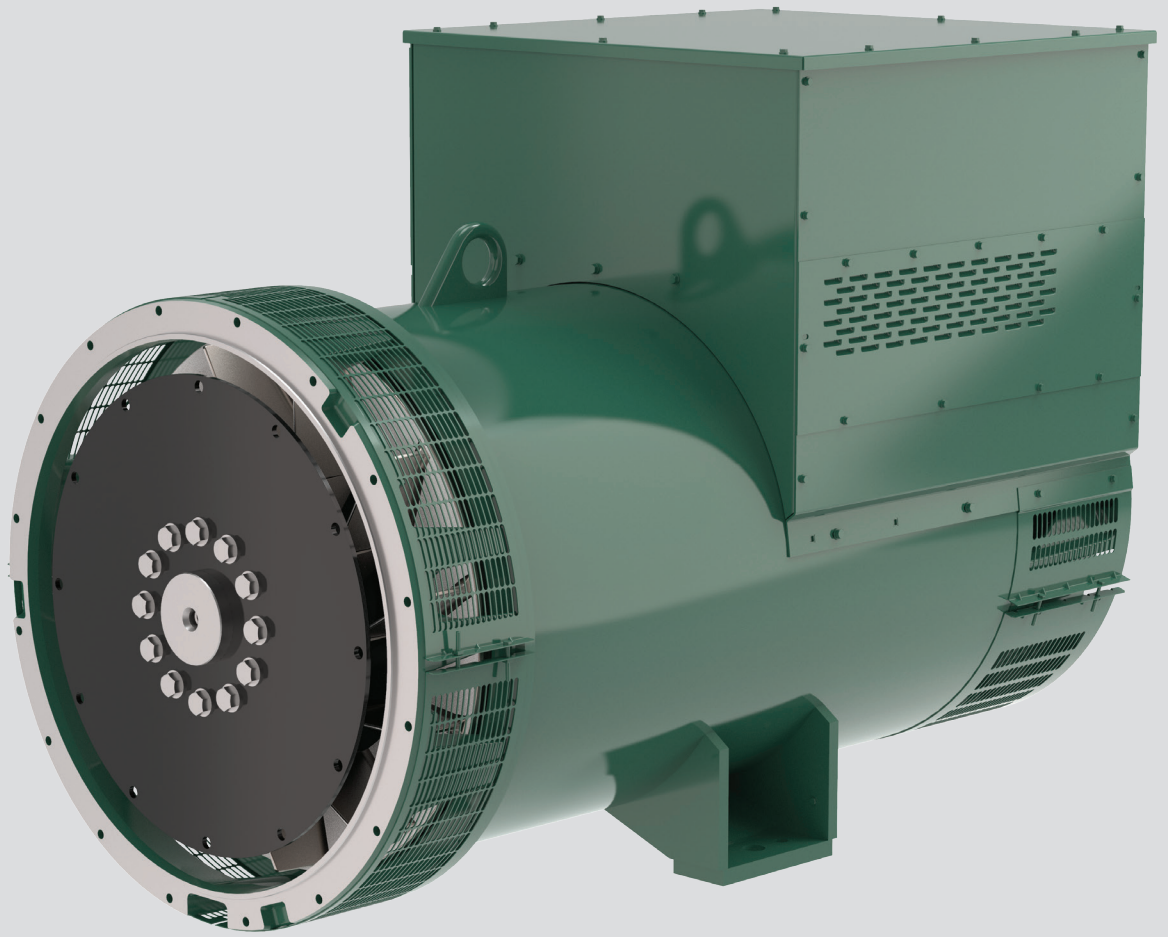



## LSA 50.2

### Low Voltage Alternator - 4 pole

1100 to 1640 kVA - 50 Hz / 1250 to 2000 kVA - 60 Hz  
Electrical and mechanical data

**LEROY-SOMER**<sup>™</sup>

***Nidec***  
All for dreams

## The best of performance

Nidec Leroy-Somer LSA 50.2 alternator has been designed to offer you the best power generation performances. With its meticulous design and optimized architecture, the LSA 50.2 strikes the perfect balance between compactness, reliability, performance and longevity.

Whatever your application, the LSA 50.2 will meet your needs and will adapt to all situations.

## Standards

Nidec Leroy-Somer LSA 50.2 alternator meets all key international standards and regulations, including IEC 60034, NEMA MG 1.32-33, ISO 8528-3, CSA C22.2 n°100-14 and UL 1446 (UL 1004 on request). Also compliant with IEC 61000-6-2, IEC 61000-6-3, IEC 61000-6-4, VDE 0875G, VDE 0875N and EN 55011, group 1 class A for European zone.

Nidec Leroy-Somer LSA 50.2 alternator can be integrated in EC marked generator set, and bears EC, EAC and CMIM markings. It is designed, manufactured and marketed in an ISO 9001 and ISO 14001 quality assurance environment.

## Electrical characteristics and performances

- Class H insulation
- 2/3 pitch winding, standard 6-wire (6S) reconnectable or 12-wire (6) optional
- Voltage range:
  - 50 Hz: 220V - 240V and 380V - 415V (440V)
  - 60 Hz: 208V - 240V and 380V - 480V
- High efficiency and motor starting capacity
- Other voltages are possible with optional adapted windings:
  - 50 Hz: 440V (no. 7), 500V (no. 9), 550V (no. 22 or 23), 600V (no. 22 or 23), 690V (no. 52)
  - 60 Hz: 380V and 416V (no. 8), 600V (no. 9), 690V (no. 22 or 23)

## Excitation and regulation system

Excitation system			Regulation options		
AVR	AREP	PMG (option)	C.T. Current transformer for paralleling	Mains paralleling	Remote voltage potentiometer
D350	Standard	Standard	√		√
D550	Option	Option	√	√	√

3-phase sensing is included as a standard with digital regulators.

## Protection system and options

- The LSA 50.2 is IP 23
- Complete winding protection for clean environments with relative humidity  $\leq 95\%$ , including indoor marine environments
- Options:
  - Filters on air inlet: derating 5%
  - Filters on air inlet and air outlet (IP 44): derating 10%
  - Reinforced winding protection for harsh environments and relative humidity greater than 95%
  - Space heater
  - Thermal protection for stator windings and shields

## Mechanical construction

- Compact and rigid assembly to better withstand generator vibrations
- Steel frame
- Cast iron flanges and shields
- Two-bearing and single-bearing versions designed to be suitable for engines on the market
- Half-key balancing
- Greased for life bearings, regreasable bearings (optional)
- Standard direction of rotation: clockwise when looking at the drive end view (for anti-clockwise, derate the machine by 5%)

## Terminal box design

- Easy access to the voltage regulator and to the connections
- Possible inclusion of accessories for paralleling, protection and measurement
- Connection bars for voltage reconnection

# LSA 50.2 - 1100 to 1640 kVA - 50 Hz / 1250 to 2000 kVA - 60 Hz

## General characteristics

Insulation class	H	Excitation system	AREP / PMG
Winding pitch	2/3 (wind.6S - 6-wire / wind.6 - 12-wire option)	AVR type	D350
Number of wires	6 (12 option)	Voltage regulation (*)	± 0.25 %
Protection	IP 23	Short-circuit current	300% (3 IN) : 10s
Altitude	≤ 1000 m	Total Harmonic Distortion THD (**) in no-load	< 3.5 %
Overspeed	2250 R.P.M.	Total Harmonic Distortion THD (**) on linear load	< 3.5 %
Air flow	1.8 m³/s (50 Hz) / 2.2 m³/s (60 Hz)	Waveform: NEMA = TIF (**)	< 50

(\*) Steady state (\*\*) Total harmonic distortion between phases, no-load or on-load (non-distorting)

## Ratings 50 Hz - 1500 R.P.M.

kVA / kW - P.F. = 0.8																	
Duty/T°C	Continuous duty/40°C				Continuous duty/40°C				Stand-by/40°C				Stand-by/27°C				
Class/T°K	H/125°K				F/105°K				H/150°K				H/163°K				
Phase	3 ph.				3 ph.				3 ph.				3 ph.				
Y	380V	400V	415V	440V	380V	400V	415V	440V	380V	400V	415V	440V	380V	400V	415V	440V	
Δ	220V	230V	240V		220V	230V	240V		220V	230V	240V		220V	230V	240V		
<b>6 wires version winding no. 6S</b>																	
<b>LSA 50.2 M6</b>	kVA	1250	<b>1250</b>	1250	1190	1125	<b>1125</b>	1125	1095	1315	<b>1315</b>	1315	1275	1375	<b>1375</b>	1375	1330
	kW	1000	<b>1000</b>	1000	952	900	<b>900</b>	900	876	1052	<b>1052</b>	1052	1020	1100	<b>1100</b>	1100	1064
<b>LSA 50.2 L7</b>	kVA	1350	<b>1350</b>	1350	1260	1215	<b>1215</b>	1215	1150	1420	<b>1420</b>	1420	1365	1485	<b>1485</b>	1485	1425
	kW	1080	<b>1080</b>	1080	1008	972	<b>972</b>	972	920	1136	<b>1136</b>	1136	1092	1188	<b>1188</b>	1188	1140
<b>LSA 50.2 L8</b>	kVA	1450	<b>1500</b>	1500	1440	1320	<b>1350</b>	1350	1320	1520	<b>1575</b>	1575	1555	1595	<b>1650</b>	1650	1625
	kW	1160	<b>1200</b>	1200	1152	1056	<b>1080</b>	1080	1056	1216	<b>1260</b>	1260	1244	1276	<b>1320</b>	1320	1300
<b>LSA 50.2 VL10</b>	kVA	1600	<b>1640</b>	1600	1545	1455	<b>1475</b>	1455	1420	1680	<b>1720</b>	1680	1670	1760	<b>1800</b>	1760	1730
	kW	1280	<b>1312</b>	1280	1236	1164	<b>1180</b>	1164	1136	1344	<b>1376</b>	1344	1336	1408	<b>1440</b>	1408	1384
<b>12 wires version winding no. 6 (option)</b>																	
Y	380V	400V	415V	440V	380V	400V	415V	440V	380V	400V	415V	440V	380V	400V	415V	440V	
Δ	220V	230V	240V		220V	230V	240V		220V	230V	240V		220V	230V	240V		
YY		200V		220V		200V		220V		200V		220V		200V		220V	
<b>LSA 50.2 M6</b>	kVA	1045	<b>1100</b>	1140	1210	940	<b>990</b>	1026	1089	1045	<b>1100</b>	1140	1210	1045	<b>1100</b>	1140	1210
	kW	836	<b>880</b>	912	968	752	<b>792</b>	821	871	836	<b>880</b>	912	968	836	<b>880</b>	912	968
<b>LSA 50.2 L8</b>	kVA	1250	<b>1300</b>	1350	1430	1125	<b>1170</b>	1215	1287	1250	<b>1300</b>	1350	1430	1250	<b>1300</b>	1350	1430
	kW	1000	<b>1040</b>	1080	1144	900	<b>936</b>	972	1030	1000	<b>1040</b>	1080	1144	1000	<b>1040</b>	1080	1144

## Ratings 60 Hz - 1800 R.P.M.

kVA / kW - P.F. = 0.8																	
Duty/T°C	Continuous duty/40°C				Continuous duty/40°C				Stand-by/40°C				Stand-by/27°C				
Class/T°K	H/125°K				F/105°K				H/150°K				H/163°K				
Phase	3 ph.				3 ph.				3 ph.				3 ph.				
Y	380V	416V	440V	<b>480V</b>	380V	416V	440V	<b>480V</b>	380V	416V	440V	<b>480V</b>	380V	416V	440V	<b>480V</b>	
Δ	220V	240V			220V	240V			220V	240V			220V	240V			
<b>6 wires version winding n°6S</b>																	
<b>LSA 50.2 M6</b>	kVA	1285	1405	1455	<b>1560</b>	1155	1265	1310	<b>1405</b>	1350	1475	1530	<b>1640</b>	1410	1545	1600	<b>1720</b>
	kW	1028	1124	1164	<b>1250</b>	924	1012	1048	<b>1124</b>	1080	1180	1224	<b>1312</b>	1128	1236	1280	<b>1376</b>
<b>LSA 50.2 L7</b>	kVA	1375	1500	1555	<b>1680</b>	1240	1350	1400	<b>1510</b>	1440	1575	1630	<b>1765</b>	1510	1650	1710	<b>1850</b>
	kW	1100	1200	1244	<b>1344</b>	992	1080	1120	<b>1208</b>	1152	1260	1304	<b>1412</b>	1208	1320	1368	<b>1480</b>
<b>LSA 50.2 L8</b>	kVA	1485	1625	1720	<b>1875</b>	1335	1460	1550	<b>1685</b>	1560	1705	1805	<b>1965</b>	1630	1785	1890	<b>2060</b>
	kW	1188	1300	1376	<b>1500</b>	1068	1168	1240	<b>1350</b>	1250	1364	1444	<b>1572</b>	1304	1428	1512	<b>1650</b>
<b>LSA 50.2 VL10</b>	kVA	1635	1785	1860	<b>2000</b>	1470	1605	1675	<b>1800</b>	1715	1875	1950	<b>2100</b>	1800	1965	2050	<b>2200</b>
	kW	1308	1428	1488	<b>1600</b>	1176	1284	1340	<b>1440</b>	1372	1500	1560	<b>1680</b>	1440	1572	1640	<b>1760</b>
<b>12 wires version winding n°6 (option)</b>																	
Y	380V	416V	440V	<b>480V</b>	380V	416V	440V	<b>480V</b>	380V	416V	440V	<b>480V</b>	380V	416V	440V	<b>480V</b>	
Δ	220V	240V	240V		220V	240V	240V		220V	240V	240V		220V	240V	240V		
YY		208V	220V	<b>240V</b>		208V	220V	<b>240V</b>		208V	220V	<b>240V</b>		208V	220V	<b>240V</b>	
<b>LSA 50.2 S4</b>	kVA	990	1080	1145	<b>1250</b>	891	972	1030	<b>1125</b>	990	1080	1145	<b>1250</b>	990	1080	1145	<b>1250</b>
	kW	792	864	916	<b>1000</b>	713	778	824	<b>900</b>	792	864	916	<b>1000</b>	792	864	916	<b>1000</b>
<b>LSA 50.2 M6</b>	kVA	1210	1320	1400	<b>1525</b>	1089	1188	1260	<b>1372</b>	1210	1320	1400	<b>1525</b>	1210	1320	1400	<b>1525</b>
	kW	968	1056	1120	<b>1220</b>	871	950	1008	<b>1098</b>	968	1056	1120	<b>1220</b>	968	1056	1120	<b>1220</b>
<b>LSA 50.2 L8</b>	kVA	1430	1565	1655	<b>1800</b>	1287	1409	1490	<b>1620</b>	1430	1565	1655	<b>1800</b>	1430	1565	1655	<b>1800</b>
	kW	1144	1252	1324	<b>1440</b>	1029	1127	1192	<b>1296</b>	1144	1252	1324	<b>1440</b>	1144	1252	1324	<b>1440</b>

**Efficiencies 400V - 50 Hz (..... P.F.: 1) (— P.F.: 0.8)**

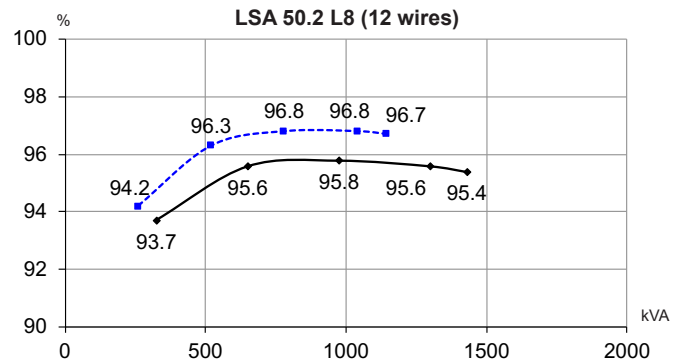
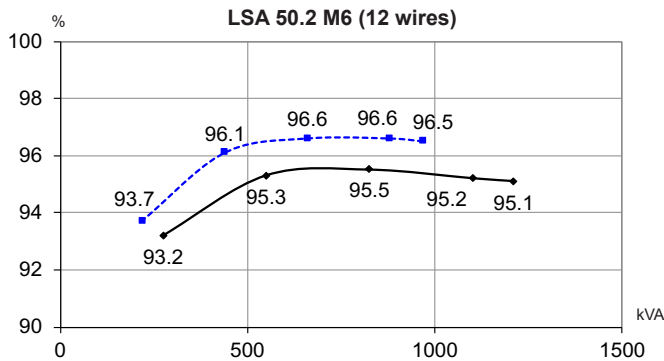
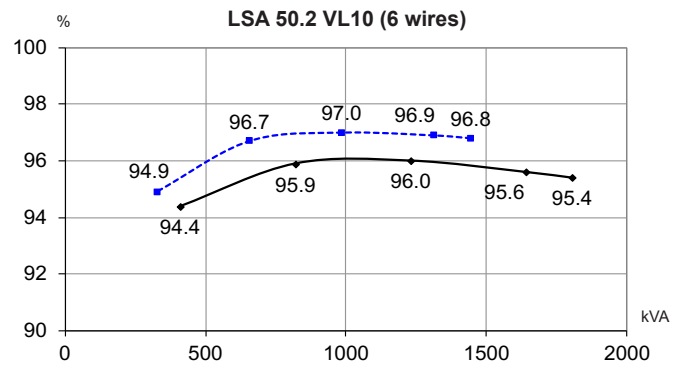
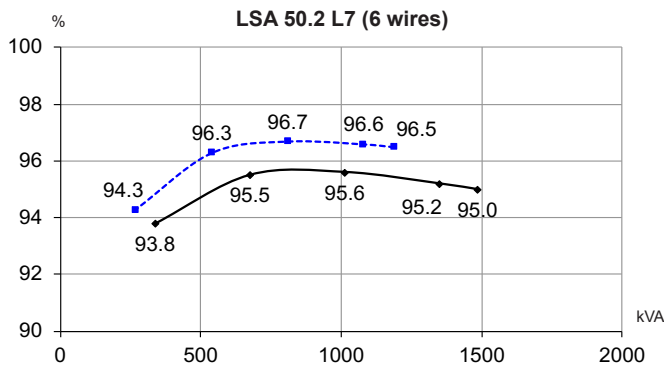
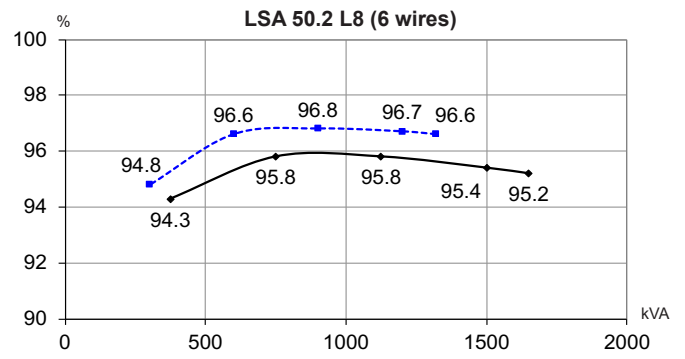
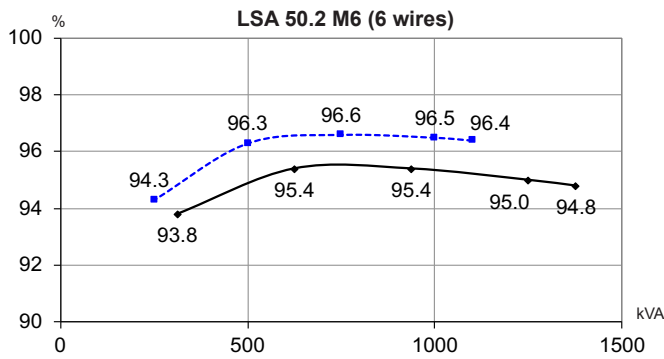

**Reactances (%). Time constants (ms) - Class H / 400 V**

	M6 (6w)	L7 (6w)	L8 (6w)	VL10 (6w)	M6 (12w)	L8 (12w)
<b>Kcc</b> Short-circuit ratio	0.32	0.34	0.32	0.33	0.36	0.37
<b>Xd</b> Direct-axis synchronous reactance unsaturated	392	364	378	362	345	329
<b>Xq</b> Quadrature-axis synchronous reactance unsaturated	200	185	193	184	176	168
<b>T'do</b> No-load transient time constant	3634	3750	3910	4058	3634	4247
<b>X'd</b> Direct-axis transient reactance saturated	29.1	26.2	26.1	24.1	25.6	20.9
<b>T'd</b> Short-circuit transient time constant	180	180	180	180	180	180
<b>X''d</b> Direct-axis subtransient reactance saturated	16.5	14.8	14.8	13.6	14.5	11.8
<b>T''d</b> Subtransient time constant	18	18	18	18	18	18
<b>X''q</b> Quadrature-axis subtransient reactance saturated	17.3	15.5	15.4	14.2	15.2	13.4
<b>Xo</b> Zero sequence reactance	0.8	0.72	0.72	0.66	0.71	0.58
<b>X2</b> Negative sequence reactance saturated	16.92	15.21	15.14	13.94	14.89	12.67
<b>Ta</b> Armature time constant	27	27	27	27	27	27

**Other class H/400 V data**

	M6 (6w)	L7 (6w)	L8 (6w)	VL10 (6w)	M6 (12w)	L8 (12w)
<b>io (A)</b> No-load excitation current	0.82	0.85	0.78	0.78	0.82	0.79
<b>ic (A)</b> On-load excitation current	3.6	3.48	3.38	3.26	3.21	3.02
<b>uc (V)</b> On-load excitation voltage	45.2	43.7	42.4	40.8	40.4	37.9
<b>ms</b> Response time ( $\Delta U = 20\%$ transient)	500	500	500	500	500	500
<b>kVA</b> Start ( $\Delta U = 20\%$ cont. or $30\%$ trans.)	2763	3324	3704	4387	2765	4003
<b>%</b> Transient $\Delta U$ (on-load 4/4) - P.F.: 0.8 <sub>LAG</sub>	13.6	12.5	12.5	11.7	12.3	10.5
<b>W</b> No-load losses	14039	15299	15454	16552	14039	15322
<b>W</b> Heat dissipation	52218	53790	57594	59458	43714	47854

Transient voltage variation 400V - 50 Hz

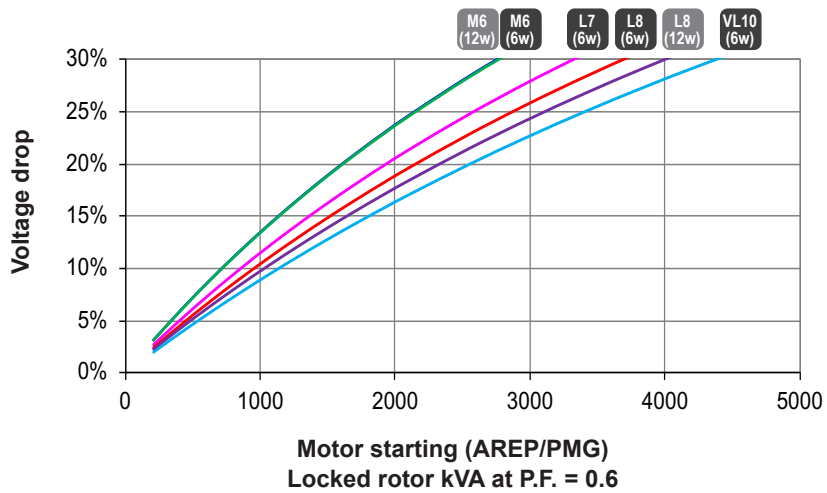
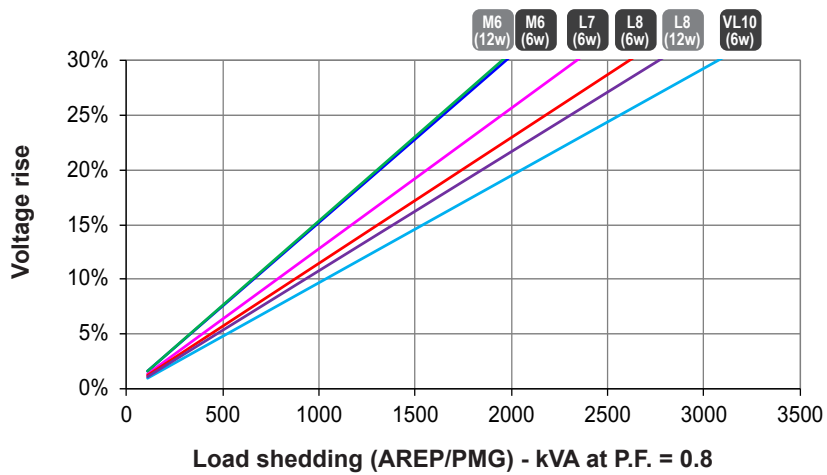
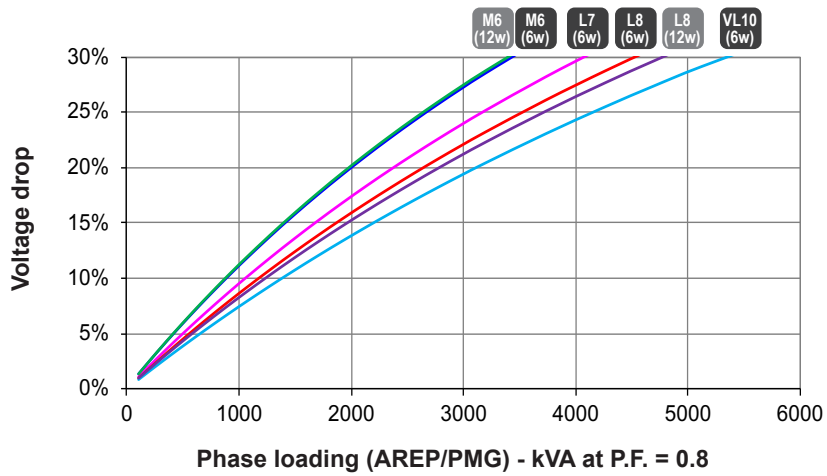

- 1) For a starting P.F. other than 0.6, the starting kVA must be multiplied by  $K = \text{Sine P.F.} / 0.8$
- 2) For voltages other than 400V (Y), 230V(Δ) at 50 Hz, then kVA must be multiplied by  $(400/U)^2$  or  $(230/U)^2$ .

**Efficiencies 480V - 60 Hz (..... P.F.: 1) (— P.F.: 0.8)**

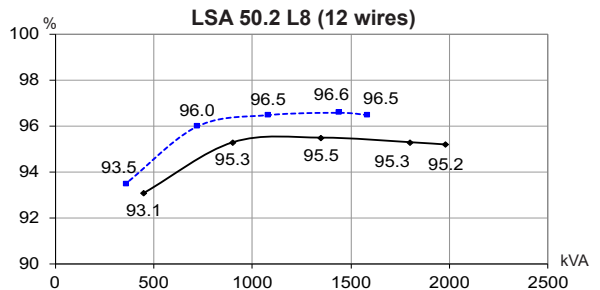
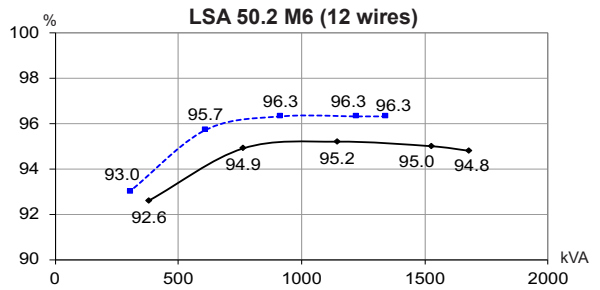
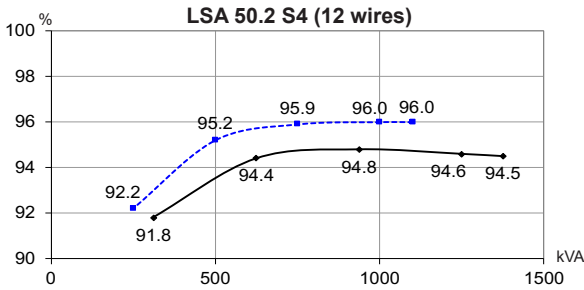
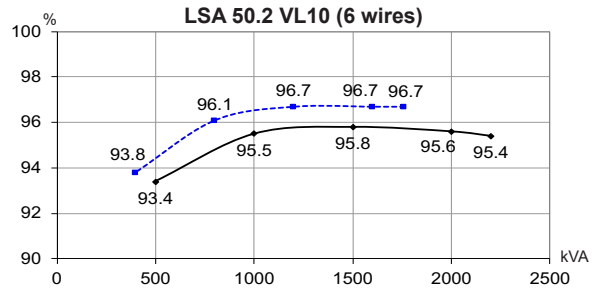
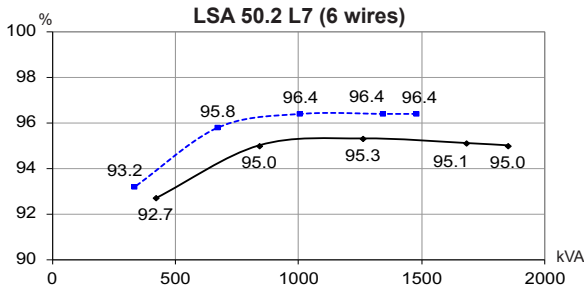
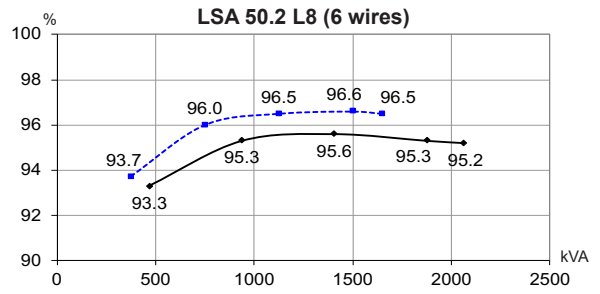
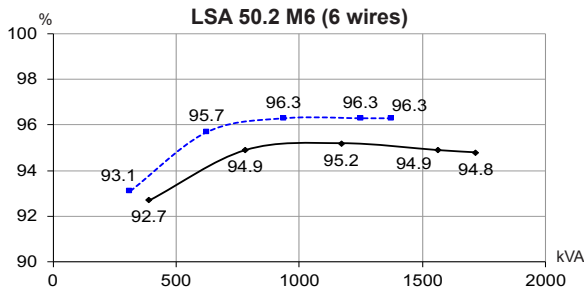

**Reactances (%). Time constants (ms) - Class H / 480 V**

	M6 (6w)	L7 (6w)	L8 (6w)	VL10 (6w)	S4 (12w)	M6 (12w)	L8 (12w)
<b>Kcc</b> Short-circuit ratio	0.31	0.33	0.3	0.32	0.3	0.31	0.32
<b>Xd</b> Direct-axis synchronous reactance unsaturated	407	377	394	368	394	398	380
<b>Xq</b> Quadrature-axis synchronous reactance unsaturated	208	192	201	187	201	203	193
<b>T'do</b> No-load transient time constant	3634	3750	3910	4058	3411	3634	4247
<b>X'd</b> Direct-axis transient reactance saturated	30.3	27.2	27.2	24.5	31.2	29.6	24.1
<b>T'd</b> Short-circuit transient time constant	180	180	180	180	180	180	180
<b>X''d</b> Direct-axis subtransient reactance saturated	17.1	15.4	15.4	13.8	17.7	16.7	13.7
<b>T''d</b> Subtransient time constant	18	18	18	18	18	18	18
<b>X''q</b> Quadrature-axis subtransient reactance saturated	18	16.1	16.1	14.4	18.6	17.6	15.5
<b>Xo</b> Zero sequence reactance	0.84	0.75	0.75	0.68	0.86	0.82	0.67
<b>X2</b> Negative sequence reactance saturated	17.6	15.78	15.77	14.17	18.19	17.21	14.62
<b>Ta</b> Armature time constant	27	27	27	27	27	27	27

**Other class H/480 V data**

<b>io (A)</b> No-load excitation current	0.82	0.85	0.78	0.78	0.78	0.82	0.79
<b>ic (A)</b> On-load excitation current	3.69	3.56	3.47	3.27	3.49	3.61	3.38
<b>uc (V)</b> On-load excitation voltage	46.4	44.8	43.6	41	44	45.5	42.5
<b>ms</b> Response time ( $\Delta U = 20\%$ transient)	500	500	500	500	500	500	500
<b>kVA</b> Start ( $\Delta U = 20\%$ cont. or 30% trans.)	3305	3977	4433	5272	2578	3321	4803
<b>%</b> Transient $\Delta U$ (on-load 4/4) - P.F.: 0.8 <sub>LAG</sub>	14	12.9	12.9	11.9	14.3	13.7	11.7
<b>W</b> No-load losses	22080	23864	24115	25675	20444	22080	23916
<b>W</b> Heat dissipation	65871	67848	72952	73168	56038	63910	69953

Transient voltage variation 480V - 60 Hz

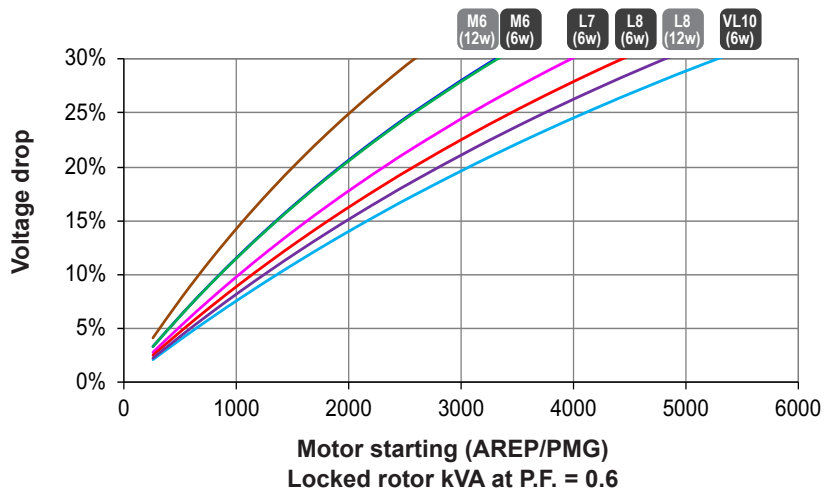
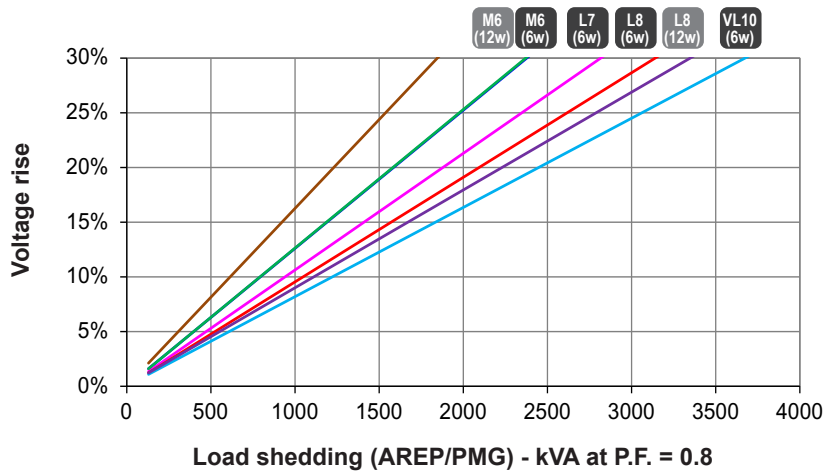
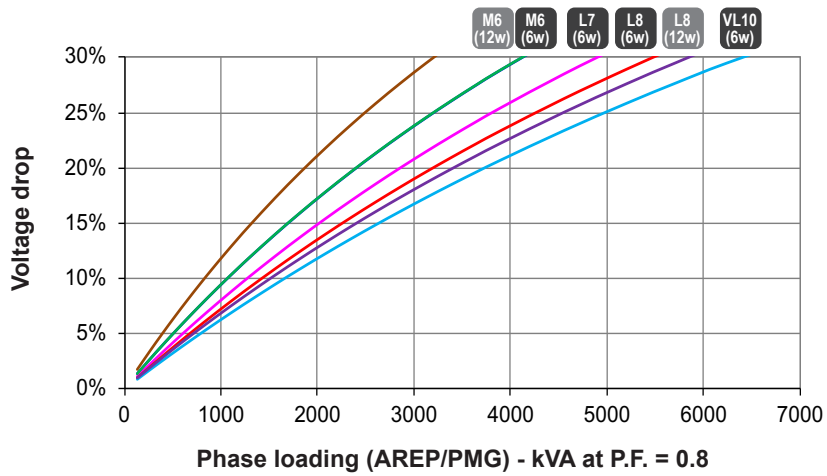

- 1) For a starting P.F. other than 0.6, the starting kVA must be multiplied by  $K = \text{Sine P.F.} / 0.8$
- 2) For voltages other than 480V (Y), 277V ( $\Delta$ ), 240V (YY) at 60 Hz, then kVA must be multiplied by  $(480/U)^2$  or  $(277/U)^2$  or  $(240/U)^2$ .



**3-phase short-circuit curves at no load and rated speed (star connection Y)**

**LSA 50.2 M6  
(6 wires)**

Symmetrical —  
Asymmetrical - - -

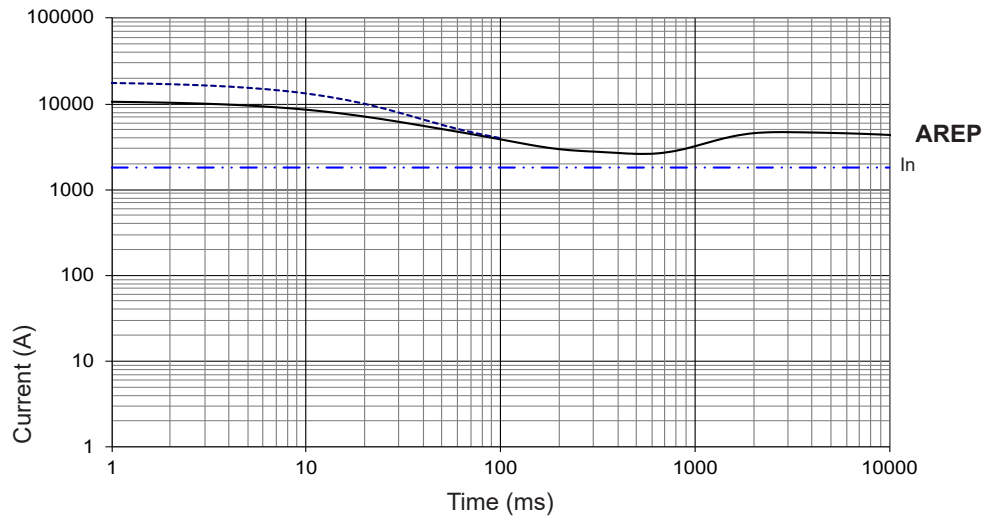

**LSA 50.2 L7  
(6 wires)**

Symmetrical —  
Asymmetrical - - -

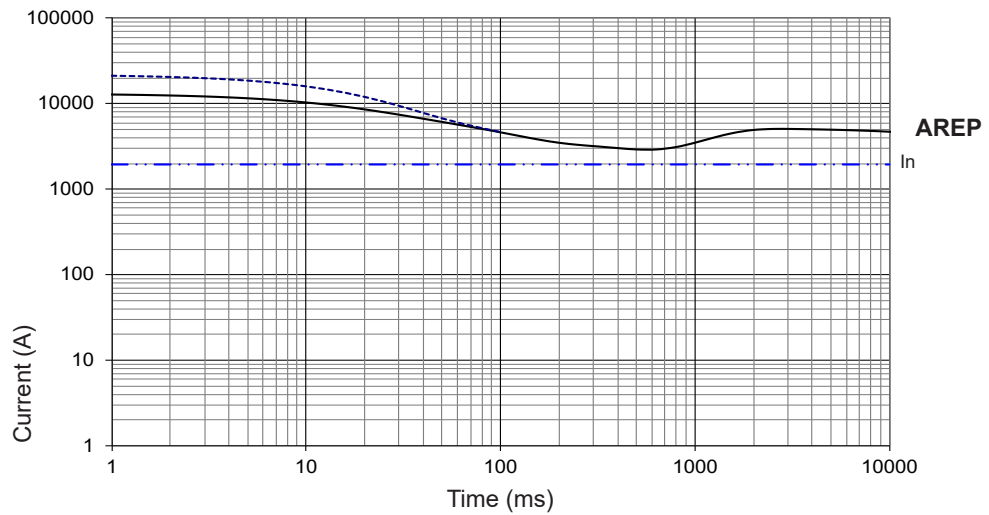

**LSA 50.2 L8  
(6 wires)**

Symmetrical —  
Asymmetrical - - -

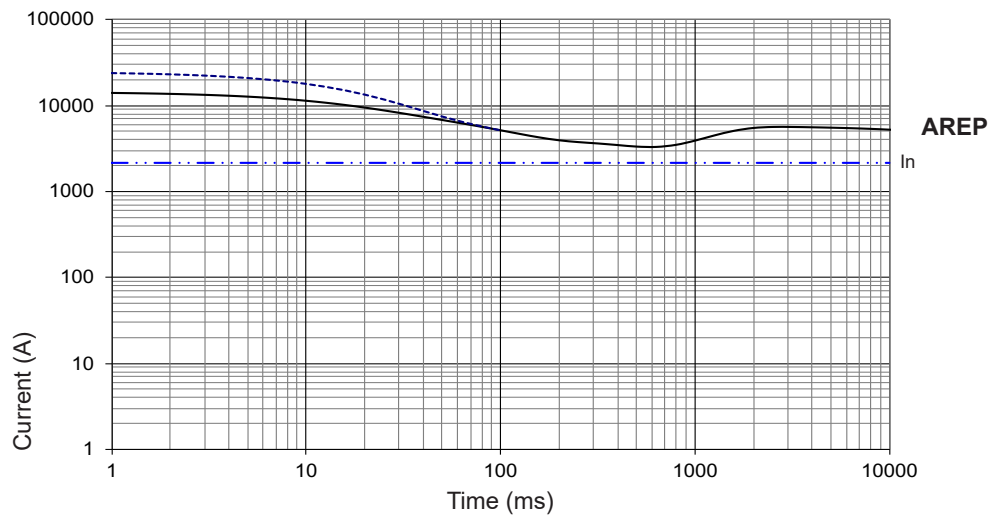

**Influence due to connection**

Curves shown are for star (Y) connection.

For other connections, use the following multiplication factors:

- Series delta : current value x 1.732 - Parallel star : current value x 2

3-phase short-circuit curves at no load and rated speed (star connection Y)

**LSA 50.2 VL10  
(6 wires)**

Symmetrical —  
Asymmetrical - - -

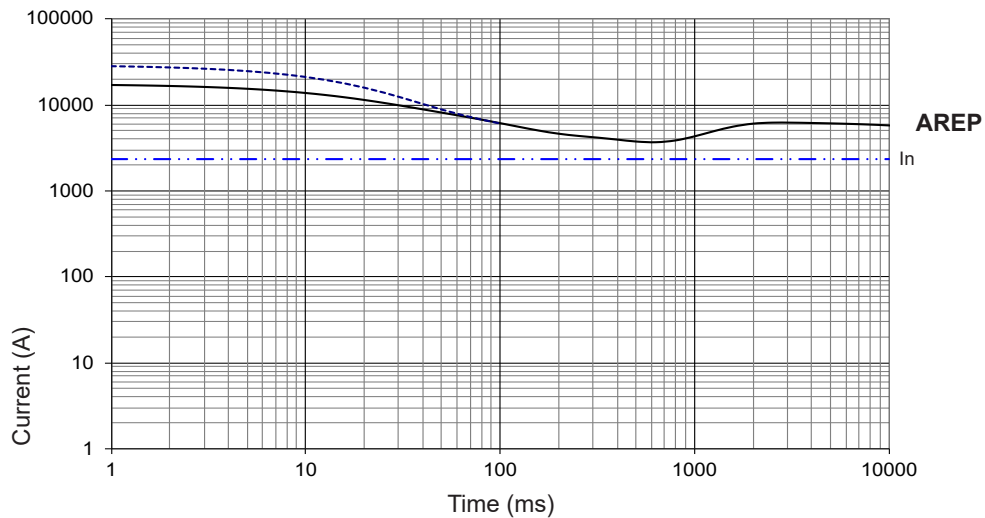

**LSA 50.2 M6  
(12 wires)**

Symmetrical —  
Asymmetrical - - -

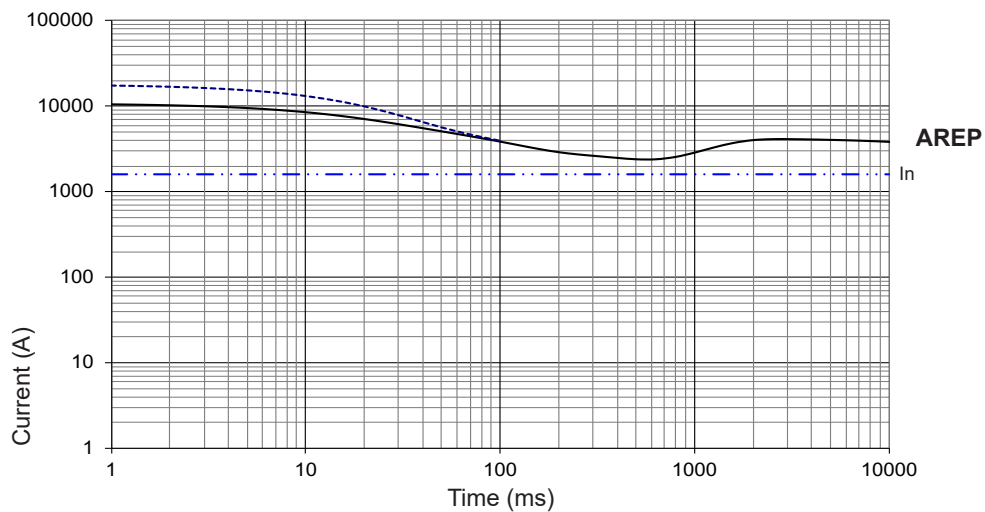

**LSA 50.2 L8  
(12 wires)**

Symmetrical —  
Asymmetrical - - -

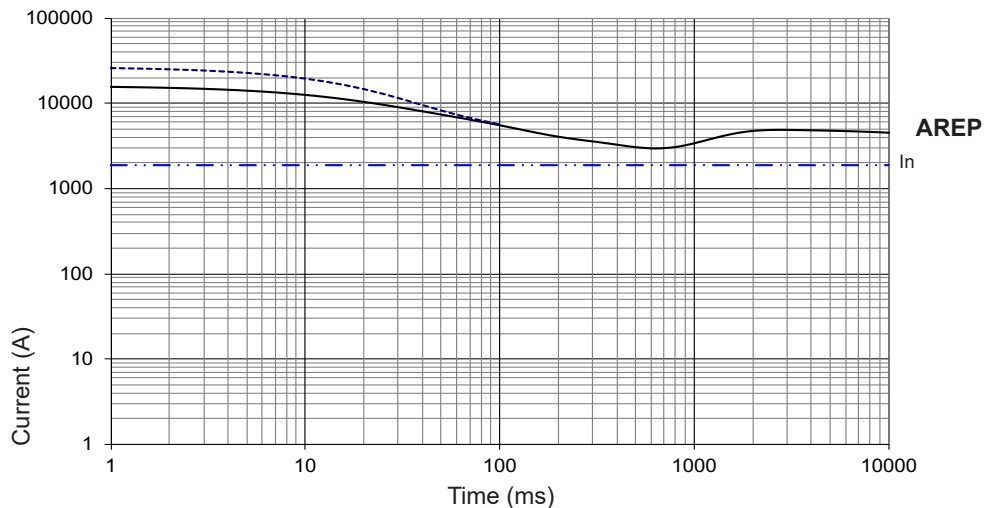

**Influence due to short-circuit**

Curves are based on a three-phase short-circuit.  
For other types of short-circuit, use the following multiplication factors.

	3-phase	2-phase L/L	1-phase L/N
Instantaneous (max.)	1	0.87	1.3
Continuous	1	1.5	2.2
Maximum duration (AREP/PMG)	10 sec.	5 sec.	2 sec.

Single-bearing dimensions

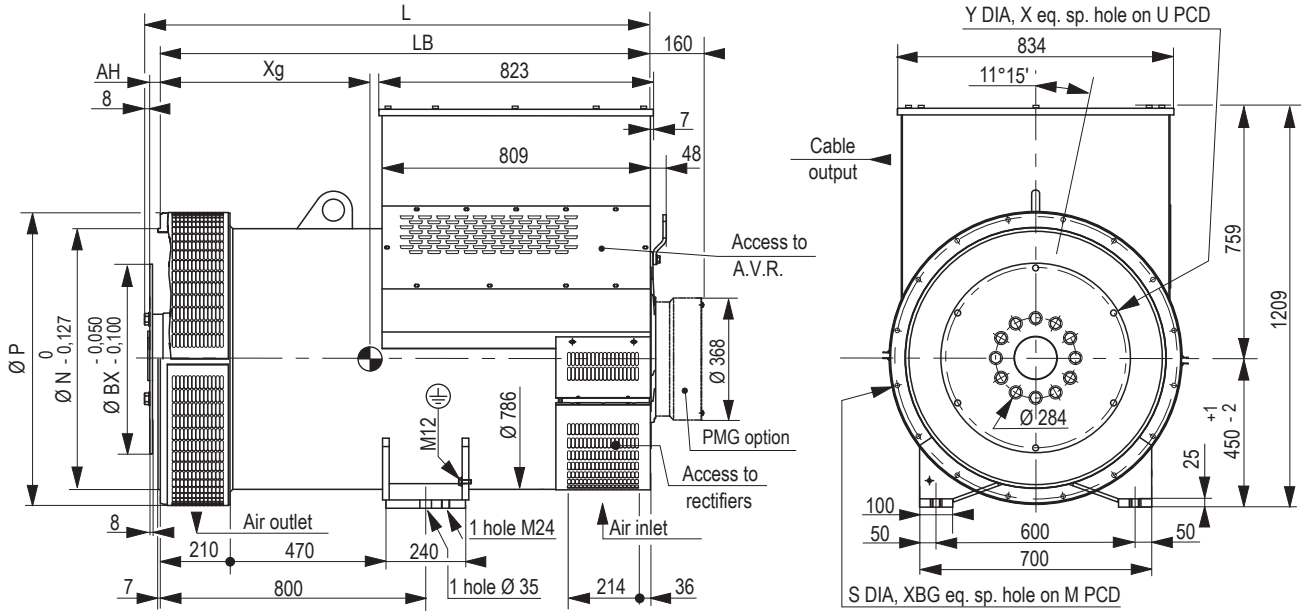

Dimensions (mm) and weight					Coupling		
Type	L without PMG maxi*	LB	Xg	Weight (kg)	Flex plate	18	21
LSA 50.2 S4	1302	1278	620	2290	Flange S.A.E 0	X	
LSA 50.2 M6	1402	1378	640	2490	Flange S.A.E 00	X	X
LSA 50.2 L7	1502	1478	690	2760			
LSA 50.2 L8	1502	1478	710	2980			
LSA 50.2 VL10	1602	1578	760	3260			

\* L maxi = LB + AH maxi + 8

Flange (mm)						Flex plate (mm)					
S.A.E.	P	N	M	XBG	β°	S.A.E.	BX	U	X	Y	AH
0	880	647.7	679.5	16	14	21	673.1	641.3	12	18	0
00	880	787.4	850.9	16	14	18	571.5	542.9	6	18	15.7

Torsional analysis data

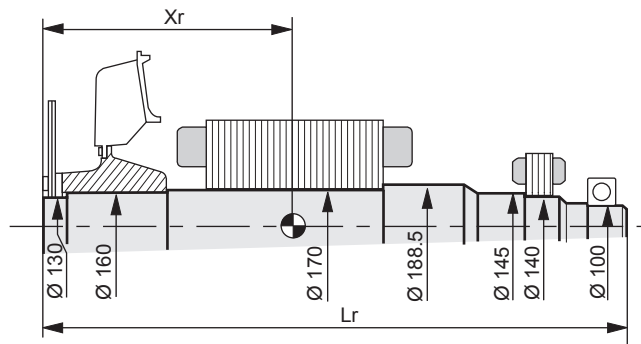

Centre of gravity: Xr (mm), Rotor length: Lr (mm), Weight: M (kg), Moment of inertia: J (kgm <sup>2</sup> ): (4J = MD <sup>2</sup> )								
Flange	S.A.E. 18				S.A.E. 21			
	Type	Xr	Lr	M	J	Xr	Lr	M
LSA 50.2 S4	564	1320.5	833	18.17	549	1320.5	831	18.62
LSA 50.2 M6	608	1420.5	934	20.6	593	1420.5	932	21.09
LSA 50.2 L7	643	1520.5	1005	22.23	627	1520.5	1003	22.68
LSA 50.2 L8	667	1520.5	1082	24.6	652	1520.5	1081	25.05
LSA 50.2 VL10	714	1620.5	1192	27.27	698	1620.5	1191	27.72

NOTE : Dimensions are for information only and may be subject to modifications. Contractual 2D drawings can be downloaded from the Leroy-Somer site, 3D drawing files are available upon request. The torsional analysis of the transmission is imperative. All values are available upon request.

## Two-bearing dimensions

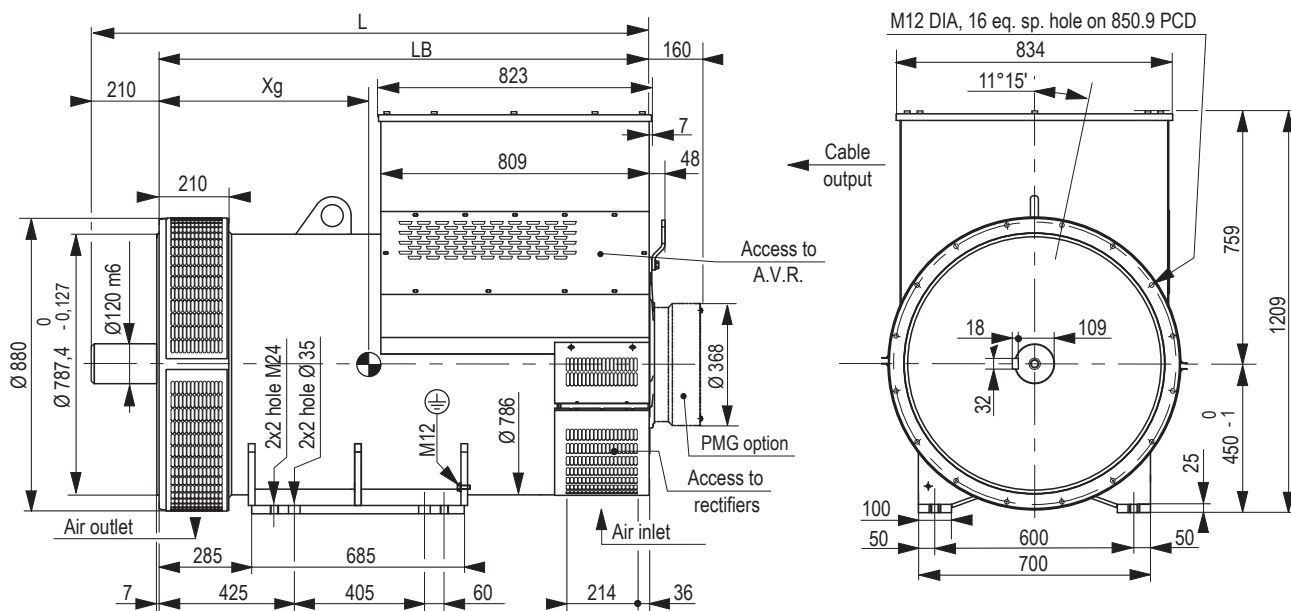

Dimensions (mm) and weight

Type	L without PMG	LB	Xg	Weight (kg)
LSA 50.2 S4	1488	1278	600	2330
LSA 50.2 M6	1588	1378	620	2530
LSA 50.2 L7	1688	1478	670	2800
LSA 50.2 L8	1688	1478	690	3010
LSA 50.2 VL10	1788	1578	740	3300

## Torsional analysis data

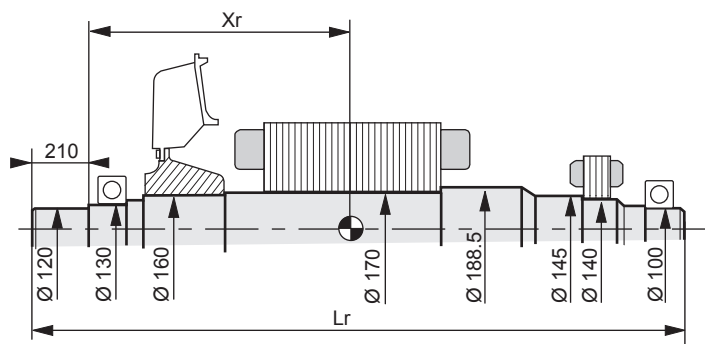

Centre of gravity: Xr (mm), Rotor length: Lr (mm), Weight: M (kg), Moment of inertia: J (kgm<sup>2</sup>): (4J = MD<sup>2</sup>)

Type	Xr	Lr	M	J
LSA 50.2 S4	567	1509	800	17.24
LSA 50.2 M6	610	1609	900	19.71
LSA 50.2 L7	645	1709	971	21.29
LSA 50.2 L8	668	1709	1049	23.66
LSA 50.2 VL10	715	1809	1159	26.33

**NOTE :** Dimensions are for information only and may be subject to modifications. Contractual 2D drawings can be downloaded from the Leroy-Somer site, 3D drawing files are available upon request. The torsional analysis of the transmission is imperative. All values are available upon request.

**LEROY-SOMER**<sup>™</sup>

[www.leroy-somer.com/epg](http://www.leroy-somer.com/epg)

[Linkedin.com/company/leroy-somer](https://www.linkedin.com/company/leroy-somer)  
[Twitter.com/Leroy\\_Somer\\_en](https://twitter.com/Leroy_Somer_en)  
[Facebook.com/LeroySomer.Nidec.en](https://www.facebook.com/LeroySomer.Nidec.en)  
[YouTube.com/LeroySomerOfficiel](https://www.youtube.com/LeroySomerOfficiel)



***Nidec***  
All for dreams

© Nidec 2020. The information contained in this brochure is for guidance only and does not form part of any contract. The accuracy cannot be guaranteed as Nidec have an ongoing process of development and reserve the right to change the specification of their products without notice.

Moteurs Leroy-Somer SAS. Siège : Bd Marcellin Leroy, CS 10015, 16915 Angoulême Cedex 9, France.  
Capital social : 38 679 664 €, RCS Angoulême 338 567 258.