

ALTERNATOR DATASHEET

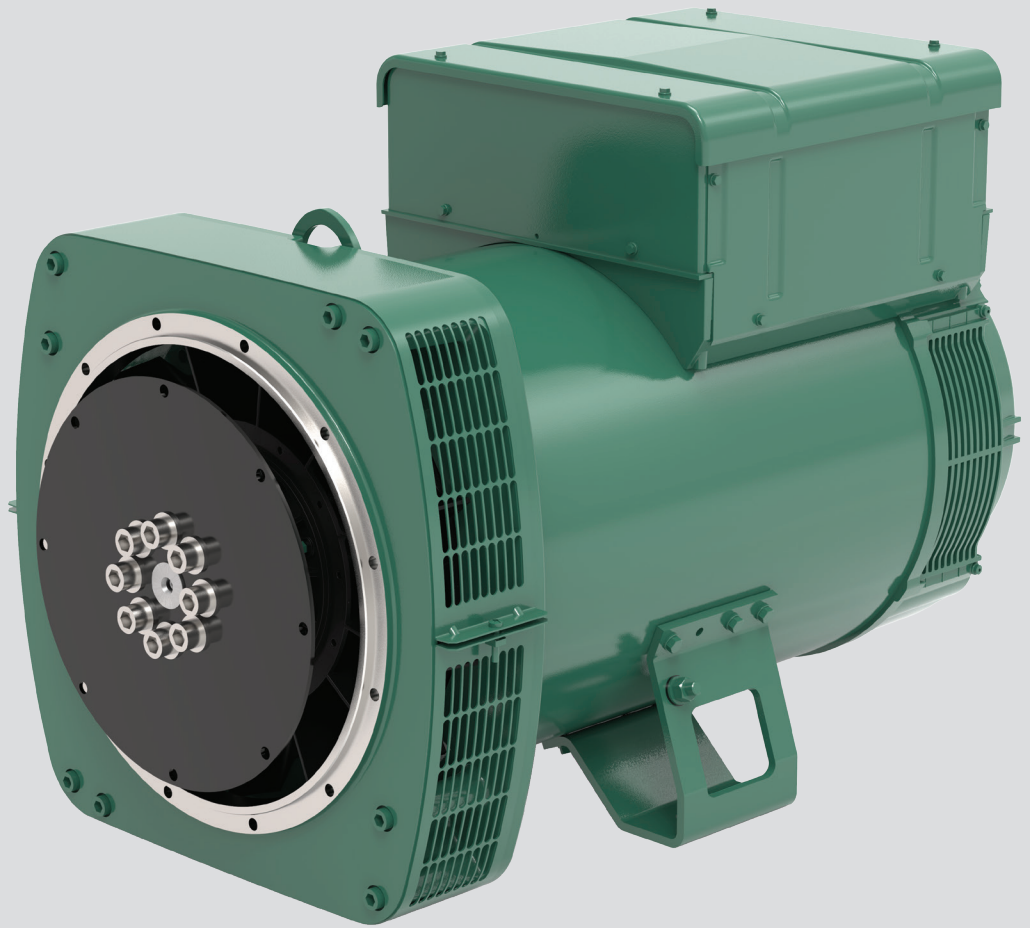



LSA 44.3

Low Voltage Alternator - 4 pole

70 to 200 kVA - 50 Hz / 88 to 250 kVA - 60 Hz

Electrical and mechanical data

LEROY-SOMER[™]

Nidec
All for dreams

The best of performance

Nidec Leroy-Somer LSA 44.3 alternator has been designed to offer you the best power generation performances. With its meticulous design and optimized architecture, the LSA 44.3 strikes the perfect balance between compactness, reliability, performance and longevity.

Whatever your application, the LSA 44.3 will meet your needs and will adapt to all situations.

Standards

Nidec Leroy-Somer LSA 44.3 alternator meets all key international standards and regulations, including IEC 60034, NEMA MG 1.32-33, ISO 8528-3, CSA C22.2 n°100-14 and UL 1446 (UL 1004 on request). Also compliant with IEC 61000-6-2, IEC 61000-6-3, IEC 61000-6-4, VDE 0875G, VDE 0875N and EN 55011, group 1 class A for European zone.

Nidec Leroy-Somer LSA 44.3 alternator can be integrated in EC marked generator set, and bears EC and CMIM markings. It is designed, manufactured and marketed in an ISO 9001 and ISO 14001 quality assurance environment.

Electrical characteristics and performances

- Class H insulation
- 2/3 pitch winding, standard 12-wire (6) reconnectable
- Voltage range:
 - 50 Hz: 220V - 240V and 380V - 415V (440V)
 - 60 Hz: 208V - 240V and 380V - 480V
- High efficiency and motor starting capacity
- Other voltages are possible with optional adapted windings:
 - 50 Hz: 440V (no. 7), 500V (no. 9), 550V (no. 22), 600V (no. 23), 690V (no. 10 or 52)
 - 60 Hz: 380V and 416V (no. 8), 600V (no. 9), 690V (no. 22)

Excitation and regulation system

Excitation system				Regulation options		
AVR	SHUNT	AREP (option)	PMG (option)	C.T. Current transformer for paralleling	Mains paralleling	Remote voltage potentiometer
R250	Standard					√
D350	Option	Standard	Standard	√*		√
D550	Option	Option	Option	√*	√	√

*: only with AREP or PMG

3-phase sensing is included as a standard with digital regulators.

Protection system and options

- The LSA 44.3 is IP 23
- Complete winding protection for clean environments with relative humidity $\leq 95\%$, including indoor marine environments
- Options:
 - Filters on air inlet: derating 5%
 - Filters on air inlet and air outlet (IP 44): derating 10%
 - Reinforced winding protection for harsh environments and relative humidity greater than 95%
 - Space heater
 - Thermal protection for stator windings
 - Shaft height: H = 225 mm and 280 mm (to be specified when ordering)
 - Cable outlet at right

Mechanical construction

- Compact rigid assembly to better withstand generator vibrations
- Steel frame and terminal box
- Aluminum/cast iron flanges and shields
- Two-bearing and single-bearing versions designed to be suitable for commercially-available heat engines
- Half-key balancing two-bearing
- Greased for life bearings (20 000h)
- Direction of rotation: clockwise and anti-clockwise (without derating)

Terminal box design

- Easy access to the voltage regulator (lid) and to the connections
- Terminal block for reconnecting the voltage

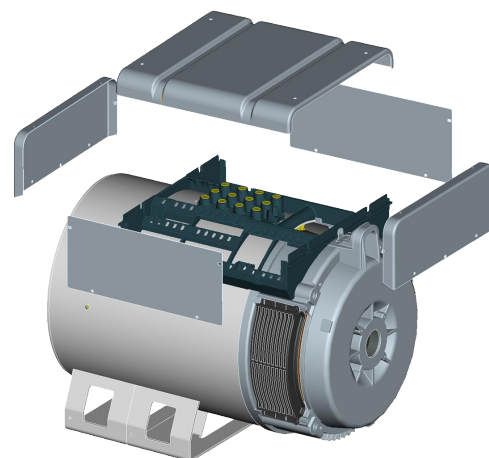

LSA 44.3 - 70 to 200 kVA - 50 Hz / 88 to 250 kVA - 60 Hz

General characteristics

Insulation class	H	Excitation system	SHUNT	AREP / PMG
Winding pitch	2/3 (wind. 6)	AVR type	R250	D350
Number of wires	12	Voltage regulation (*)	± 0.5%	± 0.25%
Protection	IP 23	Short-circuit current	-	300% (3 IN): 10 s
Altitude	≤ 1000 m	Total Harmonic Distortion THD (**) in no-load	< 2%	
Overspeed	2250 R.P.M.	Total Harmonic Distortion THD (**) on linear load ...	< 5%	
Air flow	0.25m³/s (50 Hz) - 0.30m³/s (60 Hz)	Waveform: NEMA = TIF (**)	< 50	
Air flow (***)	0.29m³/s (50 Hz) - 0.34m³/s (60 Hz)	(*) Steady state (**) Total harmonic distortion between phases, no-load or on-load (non-distorting)		

(***) Only for LS 44.3 L12, VL13 & VL14

Ratings 50 Hz - 1500 R.P.M.

kVA / kW * - P.F. = 0.8		Continuous duty/40°C					Continuous duty/40°C					Stand-by/40°C					Stand-by/27°C				
Duty/T°C		H/125°K					F/105°K					H/150°K					H/163°K				
Class/T°K		H/125°K					F/105°K					H/150°K					H/163°K				
Phase		3 ph.		1 ph.			3 ph.		1 ph.			3 ph.		1 ph.			3 ph.		1 ph.		
Y		380V	400V	415V	440V	ΔΔ	380V	400V	415V	440V	ΔΔ	380V	400V	415V	440V	ΔΔ	380V	400V	415V	440V	ΔΔ
Δ		220V	230V	240V		230V	220V	230V	240V		230V	220V	230V	240V		230V	220V	230V	240V		230V
YY			200V		220V			200V		220V			200V		220V			200V		220V	
LSA 44.3 S2	kVA	70	70	70	63	42	64	64	64	57	38	74	74	74	67	45	77	77	77	69	46
	kW	56	56	56	50	33.5	51	51	51	46	30.5	59	59	59	54	36	62	62	62	55	37
LSA 44.3 S3	kVA	80	80	80	72	48	73	73	73	66	44	85	85	85	76	51	88	88	88	79	53
	kW	64	64	64	58	38.5	58	58	58	53	35	68	68	68	61	41	70	70	70	63	42
LSA 44.3 S4	kVA	90	90	90	81	54	82	82	82	74	49	95	95	95	86	57	100	100	100	89	59
	kW	72	72	72	65	43	66	66	66	59	39	76	76	76	69	46	80	80	80	71	47
LSA 44.3 S5	kVA	100	100	100	90	60	91	91	91	82	55	106	106	106	95	64	110	110	110	99	66
	kW	80	80	80	72	48	73	73	73	66	44	85	85	85	76	51	88	88	88	79	53
LSA 44.3 M6	kVA	125	125	125	113	67	114	114	114	103	61	133	133	133	120	71	138	138	138	124	74
	kW	100	100	100	90	54	91	91	91	82	49	106	106	106	96	57	110	110	110	99	59
LSA 44.3 M8	kVA	135	135	135	122	73	123	123	123	111	66	143	143	143	129	77	150	150	150	134	80
	kW	108	108	108	98	58	98	98	98	89	53	114	114	114	103	62	120	120	120	107	64
LSA 44.3 L10	kVA	150	150	150	135	80	137	137	137	123	73	159	159	159	143	85	165	165	165	149	88
	kW	120	120	120	108	64	110	110	110	98	58	127	127	127	114	68	132	132	132	119	70
LSA 44.3 L12	kVA	165	165	165	138	88	150	150	150	126	80	175	175	175	150	93	182	182	182	157	97
	kW	132	132	132	110	70	120	120	120	101	64	140	140	140	120	74	146	146	146	126	78
LSA 44.3 VL13	kVA	180	180	180	171	90	164	164	164	156	82	191	191	191	181	95	200	200	200	188	99
	kW	144	144	144	137	72	131	131	131	125	66	153	153	153	145	76	160	160	160	150	79
LSA 44.3 VL14	kVA	192	200	200	192	100	175	182	182	175	91	204	212	212	204	106	211	220	220	211	110
	kW	154	160	160	154	80	140	146	146	140	73	163	170	170	163	85	169	176	176	169	88

Ratings 60 Hz - 1800 R.P.M.

kVA / kW * - P.F. = 0.8		Continuous duty/40°C					Continuous duty/40°C					Stand-by/40°C					Stand-by/27°C				
Duty/T°C		H/125°K					F/105°K					H/150°K					H/163°K				
Class/T°K		H/125°K					F/105°K					H/150°K					H/163°K				
Phase		3 ph.		1 ph.			3 ph.		1 ph.			3 ph.		1 ph.			3 ph.		1 ph.		
Y		380V	416V	440V	480V	ΔΔ	380V	416V	440V	480V	ΔΔ	380V	416V	440V	480V	ΔΔ	380V	416V	440V	480V	ΔΔ
Δ		220V	240V		240V	240V	220V	240V		240V	240V	220V	240V		240V	240V	220V	240V		240V	240V
YY			208V	220V	240V			208V	220V	240V			208V	220V	240V			208V	220V	240V	
LSA 44.3 S2	kVA	69	76	80	88	46	63	69	73	80	42	73	81	85	93	49	76	84	88	97	51
	kW	55	61	64	70	37	50	55	58	64	33.5	58	65	68	74	39	61	67	70	78	41
LSA 44.3 S3	kVA	79	87	92	100	52	72	79	84	91	47	84	92	98	106	55	87	96	101	110	57
	kW	63	70	74	80	42	58	63	67	73	37.5	67	74	78	85	44	70	77	81	88	46
LSA 44.3 S4	kVA	89	98	103	113	59	81	89	94	103	54	94	104	109	120	63	98	108	113	124	65
	kW	71	78	82	90	47	65	71	75	82	43	75	83	87	96	50	78	86	90	99	52
LSA 44.3 S5	kVA	99	108	115	125	65	90	99	105	114	59	105	114	122	133	69	109	119	127	138	72
	kW	79	86	92	100	52	72	79	84	91	47	84	91	98	106	55	87	95	102	110	58
LSA 44.3 M6	kVA	124	135	143	156	76	113	123	130	142	69	131	143	152	165	81	136	149	157	172	84
	kW	99	108	114	125	61	90	98	104	114	55	105	114	122	132	65	109	119	126	138	67
LSA 44.3 M8	kVA	134	146	155	169	81	122	133	141	154	74	142	155	164	179	86	147	161	171	186	89
	kW	107	117	124	135	65	98	106	113	123	59	114	124	131	143	69	118	129	137	149	71
LSA 44.3 L10	kVA	148	163	172	188	95	135	148	157	171	86	157	173	182	199	101	163	179	189	207	105
	kW	118	130	138	150	76	108	118	126	137	69	126	138	146	159	81	130	143	151	166	84
LSA 44.3 L12	kVA	165	179	189	206	105	150	163	172	187	96	175	190	200	218	111	182	197	208	227	116
	kW	132	143	151	165	84	120	130	138	150	77	140	152	160	174	89	146	158	166	182	93
LSA 44.3 VL13	kVA	180	195	210	225	113	164	177	191	205	102	191	207	223	239	119	200	215	231	250	124
	kW	144	156	168	180	90	131	142	153	164	82	153	166	178	191	95	160	172	185	200	99
LSA 44.3 VL14	kVA	200	215	230	250	125	182	196	209	228	114	212	228	244	265	133	220	237	253	275	136
	kW	160	172	184	200	100	146	157	167	182	91	170	182	195	212	106	176	190	202	220	109

* Values are rounded-off and are subject to change without notice by the manufacturer.

LSA 44.3 - 70 to 200 kVA - 50 Hz / 88 to 250 kVA - 60 Hz

Efficiencies 400 V - 50 Hz (— P.F.: 0.8) (- - - P.F.: 1)

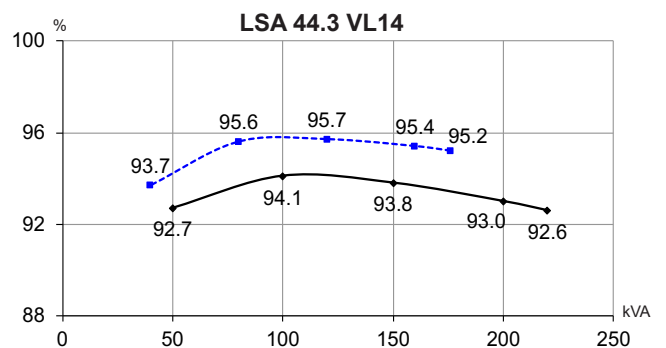
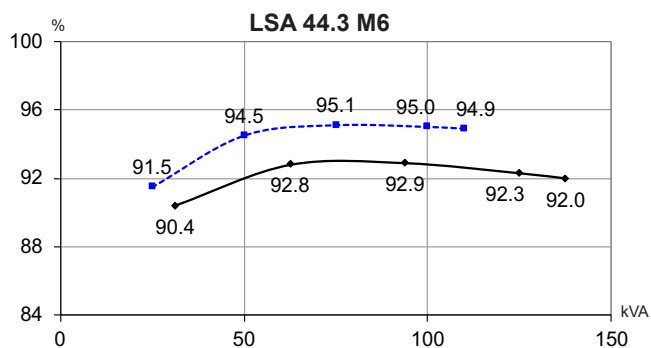
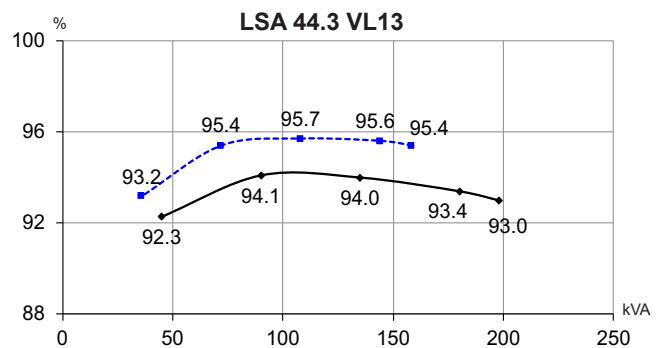
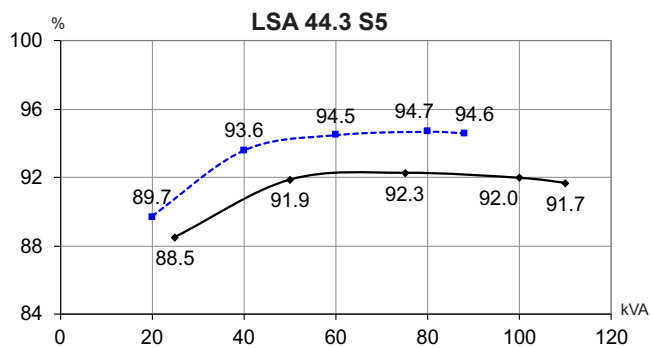
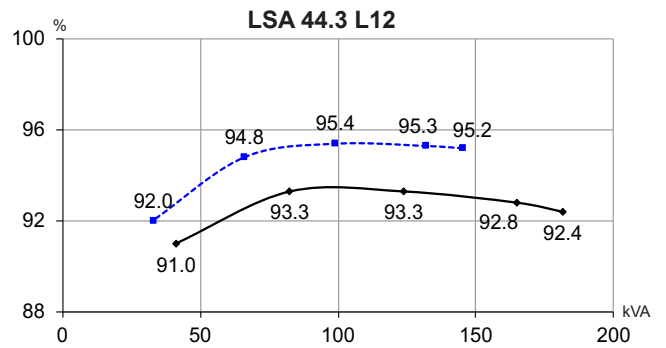
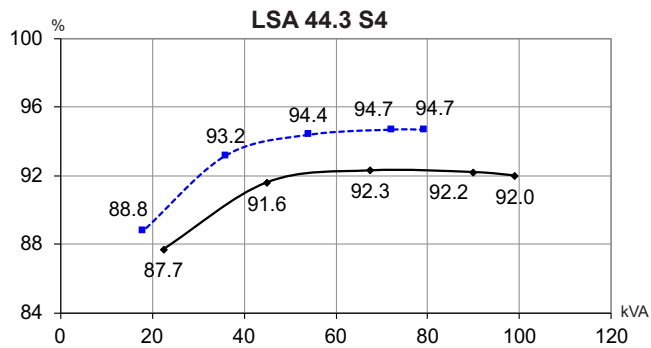
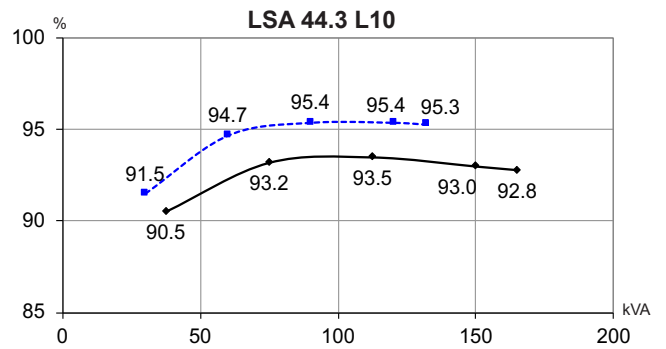
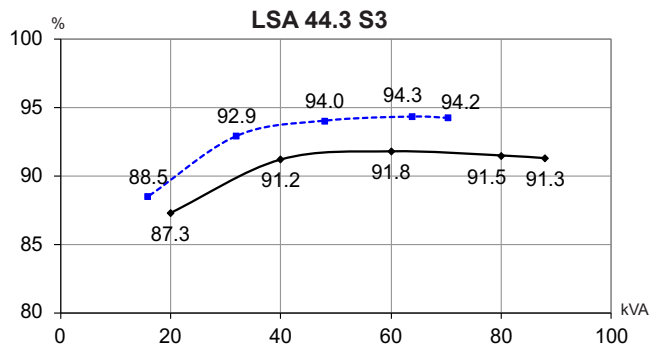
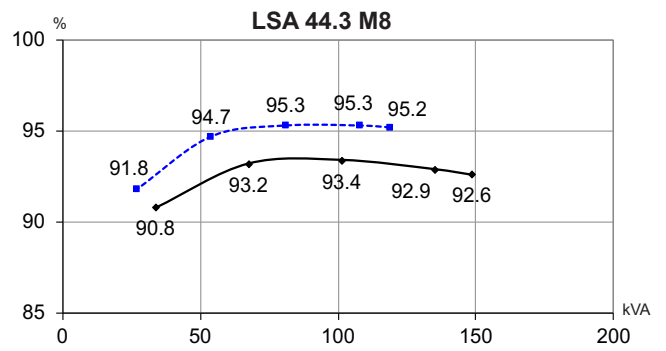
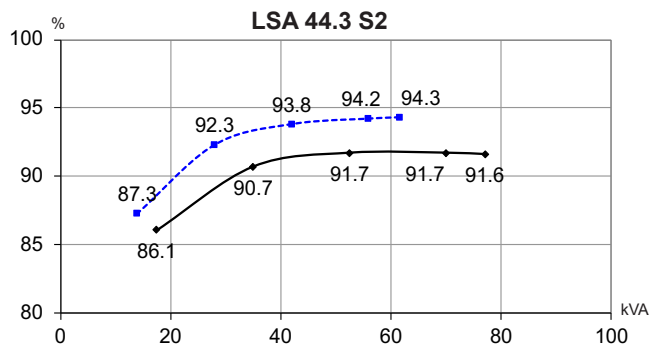

LSA 44.3 - 70 to 200 kVA - 50 Hz / 88 to 250 kVA - 60 Hz

Efficiencies 480 V - 60 Hz (— P.F.: 0.8) (- - - P.F.: 1)

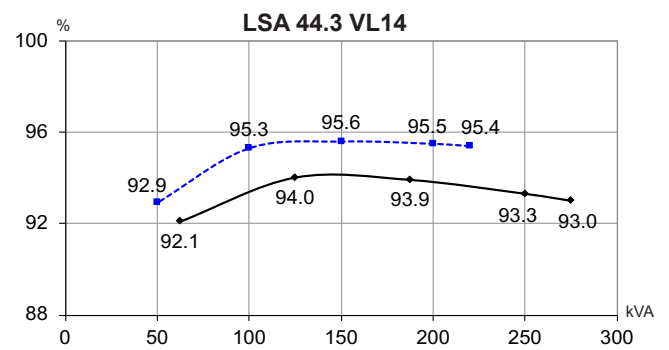
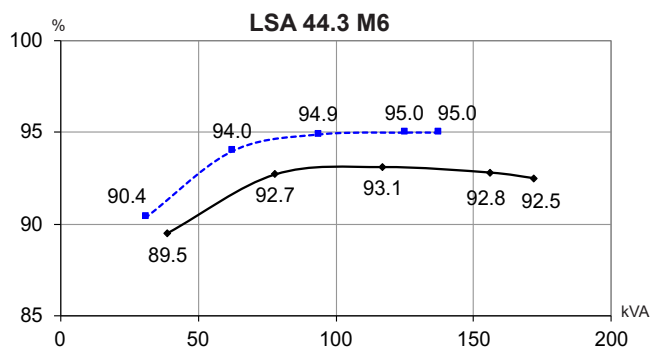
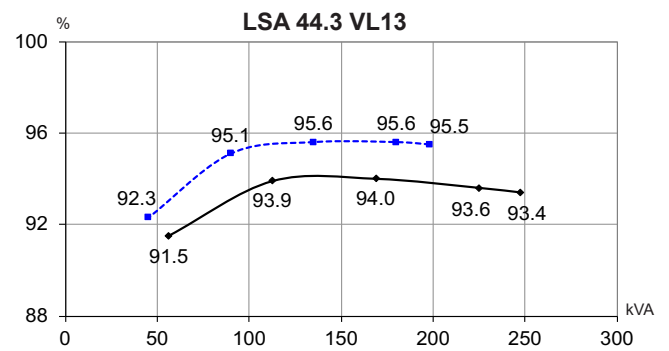
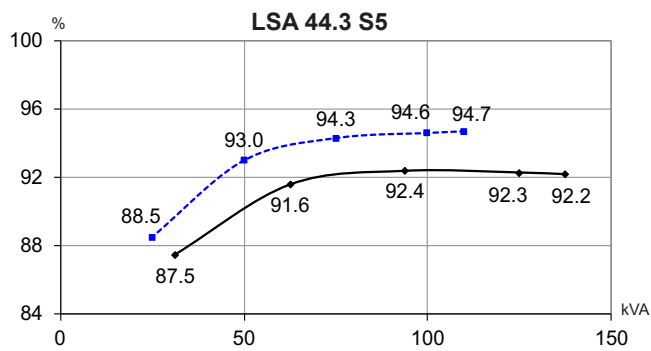
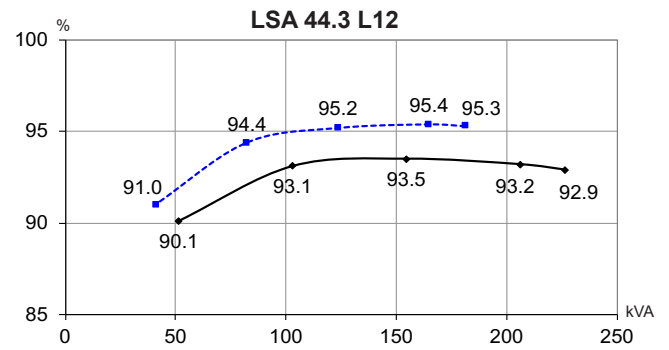
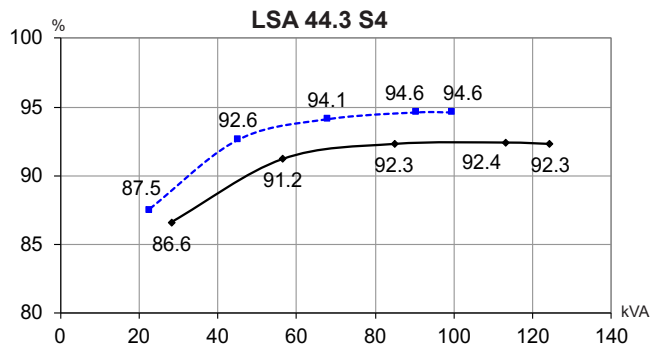
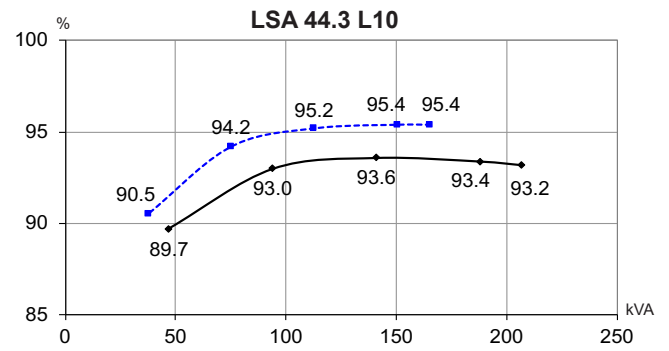
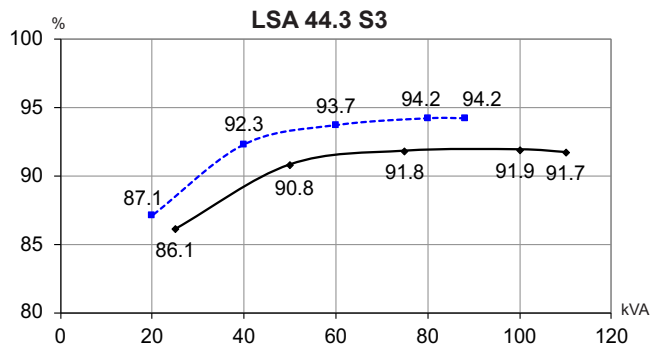
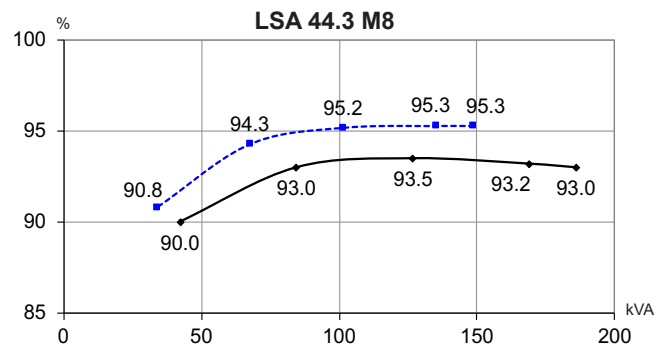
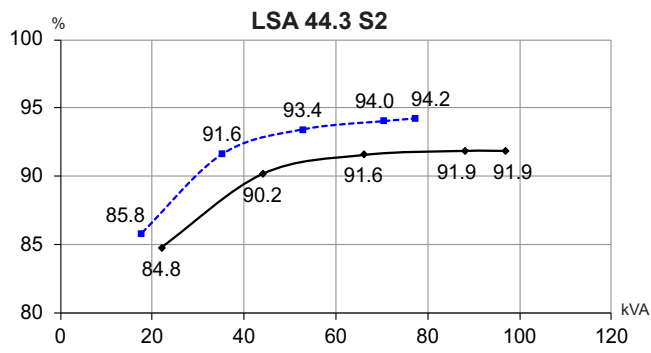

Reactances (%). Time constants (ms) - Class H / 400 V

	S2	S3	S4	S5	M6	M8	L10	L12	VL13	VL14
Kcc Short-circuit ratio	0.68	0.59	0.61	0.55	0.45	0.44	0.49	0.44	0.37	0.33
Xd Direct-axis synchronous reactance unsaturated	239	273	258	287	329	323	305	335	343	381
Xq Quadrature-axis synchronous reactance unsaturated	121	139	131	146	167	165	155	171	175	194
T'do No-load transient time constant	2308	2308	2211	2211	2154	2112	2077	2077	2025	2025
X'd Direct-axis transient reactance saturated	10.3	11.8	11.6	12.9	15.2	15.3	14.6	16.1	16.9	18.8
T'd Short-circuit transient time constant	100	100	100	100	100	100	100	100	100	100
X''d Direct-axis subtransient reactance saturated	6.2	7	7	7.7	9.1	9.1	8.8	9.6	10.1	11.3
T''d Subtransient time constant	10	10	10	10	10	10	10	10	10	10
X''q Quadrature-axis subtransient reactance saturated	13.2	15.1	14.5	16.1	18.6	18.3	17.4	19.1	19.7	21.9
Xo Zero sequence reactance	0.43	0.49	0.48	0.54	0.63	0.63	0.61	0.67	0.7	0.78
X2 Negative sequence reactance saturated	9.74	11.13	10.75	11.95	13.89	13.78	13.11	14.42	14.96	16.62
Ta Armature time constant	15	15	15	15	15	15	15	15	15	15

Other class H / 400 V data

io (A) No-load excitation current SHUNT	0.75	0.75	0.73	0.73	0.66	0.62	0.67	0.67	0.78	0.78
io (A) No-load excitation current AREP	0.97	0.97	0.94	0.94	0.85	0.81	0.86	0.86	0.78	0.78
ic (A) On-load excitation current SHUNT	2.07	2.33	2.11	2.31	2.47	2.37	2.45	2.71	3.17	3.53
ic (A) On-load excitation current AREP	2.67	3	2.71	2.98	3.18	3.05	3.15	3.49	3.17	3.53
uc (V) On-load excitation voltage SHUNT	23.1	25.8	26.5	28.9	30.6	29.3	29.9	32.7	16.2	17.9
uc (V) On-load excitation voltage AREP	18.6	20.7	21.3	23.2	24.5	23.5	24	26.3	16.2	17.9
ms Response time ($\Delta U = 20\%$ transient)	500	500	500	500	500	500	500	500	500	500
kVA Start ($\Delta U = 20\%$ cont. or $\Delta U = 30\%$ trans.) SHUNT*	184	184	292	293	310	334	371	379	487	487
kVA Start ($\Delta U = 20\%$ cont. or $\Delta U = 30\%$ trans.) AREP*	222	221	344	344	366	400	414	414	545	545
% Transient ΔU (on-load 4/4) SHUNT - P.F.: 0.8 _{LAG}	13.3	14.5	11.6	12.4	13.8	13.8	13.4	14.3	13	13.9
% Transient ΔU (on-load 4/4) AREP - P.F.: 0.8 _{LAG}	11.8	12.9	10.4	11.1	12.3	12.3	12	12.7	11.6	12.4
W No-load losses	2174	2174	2396	2396	2387	2478	2894	2946	2670	2670
W Heat dissipation	5025	5892	6073	6935	8254	8251	8914	10236	10165	11933

* P.F. = 0.6

Reactances (%). Time constants (ms) - Class H / 480 V

	S2	S3	S4	S5	M6	M8	L10	L12	VL13	VL14
Kcc Short-circuit ratio	0.65	0.57	0.58	0.53	0.43	0.42	0.47	0.43	0.36	0.32
Xd Direct-axis synchronous reactance unsaturated	250	284	270	299	342	337	318	349	358	397
Xq Quadrature-axis synchronous reactance unsaturated	127	145	137	152	174	172	162	178	182	202
T'do No-load transient time constant	2308	2308	2211	2211	2154	2112	2077	2077	2025	2025
X'd Direct-axis transient reactance saturated	10.8	12.3	12.2	13.5	15.8	15.9	15.3	16.8	17.6	19.6
T'd Short-circuit transient time constant	100	100	100	100	100	100	100	100	100	100
X''d Direct-axis subtransient reactance saturated	6.5	7.3	7.3	8.1	9.5	9.5	9.2	10	10.6	11.7
T''d Subtransient time constant	10	10	10	10	10	10	10	10	10	10
X''q Quadrature-axis subtransient reactance saturated	13.9	15.7	15.1	16.7	19.3	19.1	18.1	19.9	20.5	22.8
Xo Zero sequence reactance	0.45	0.51	0.5	0.56	0.66	0.66	0.63	0.7	0.73	0.81
X2 Negative sequence reactance saturated	10.2	11.59	11.25	12.44	14.44	14.37	13.7	15	15.59	17.32
Ta Armature time constant	15	15	15	15	15	15	15	15	15	15

Other class H / 480 V data

io (A) No-load excitation current SHUNT	0.75	0.75	0.73	0.73	0.66	0.62	0.67	0.67	0.77	0.77
io (A) No-load excitation current AREP	0.97	0.97	0.94	0.94	0.85	0.81	0.86	0.86	0.77	0.77
ic (A) On-load excitation current SHUNT	2.08	2.31	2.13	2.32	2.47	2.38	2.44	2.68	3.21	3.56
ic (A) On-load excitation current AREP	2.67	2.98	2.75	2.99	3.18	3.06	3.14	3.45	3.21	3.56
uc (V) On-load excitation voltage SHUNT	23.5	26	27	29.4	31	29.7	30.3	33	16.6	18.3
uc (V) On-load excitation voltage AREP	18.8	20.8	21.7	23.6	24.9	23.9	24.3	26.5	16.6	18.3
ms Response time ($\Delta U = 20\%$ transient)	500	500	500	500	500	500	500	500	500	500
kVA Start ($\Delta U = 20\%$ cont. or $\Delta U = 30\%$ trans.) SHUNT*	220	222	352	351	374	403	465	466	589	587
kVA Start ($\Delta U = 20\%$ cont. or $\Delta U = 30\%$ trans.) AREP*	265	265	422	423	446	481	541	544	708	706
% Transient ΔU (on-load 4/4) SHUNT - P.F.: 0.8 _{LAG}	13.7	14.9	12	12.7	14.1	14.2	13.8	14.7	13.3	14.3
% Transient ΔU (on-load 4/4) AREP - P.F.: 0.8 _{LAG}	12.2	13.2	10.7	11.4	12.6	12.6	12.3	13	11.9	12.7
W No-load losses	3188	3188	3501	3501	3506	3639	4217	4308	3928	3928
W Heat dissipation	6152	7047	7349	8241	9669	9747	10581	11988	12155	14140

* P.F. = 0.6

Transient voltage variation 400V - 50 Hz

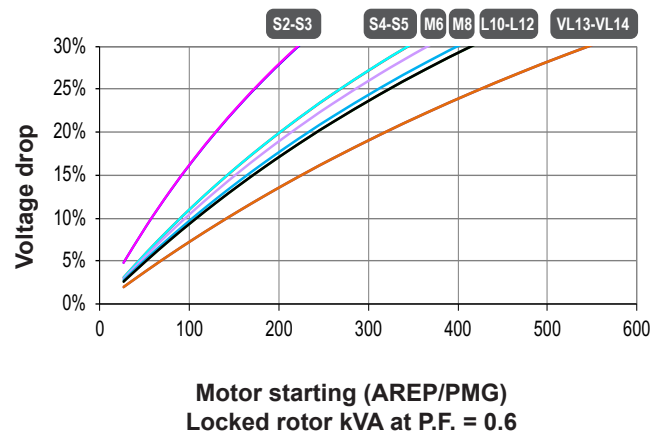
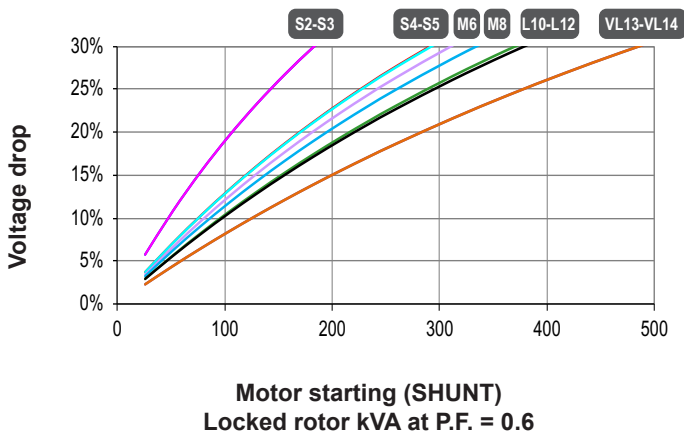
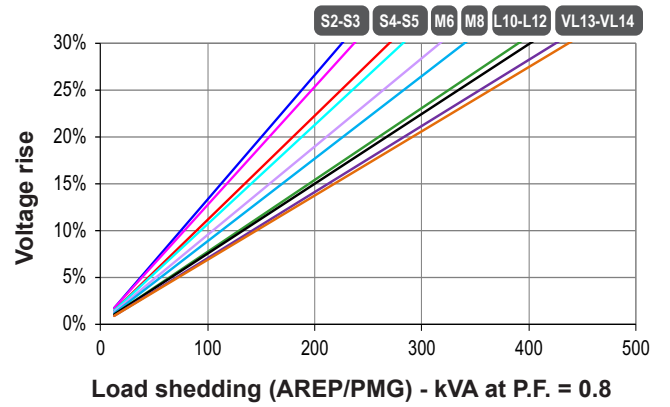
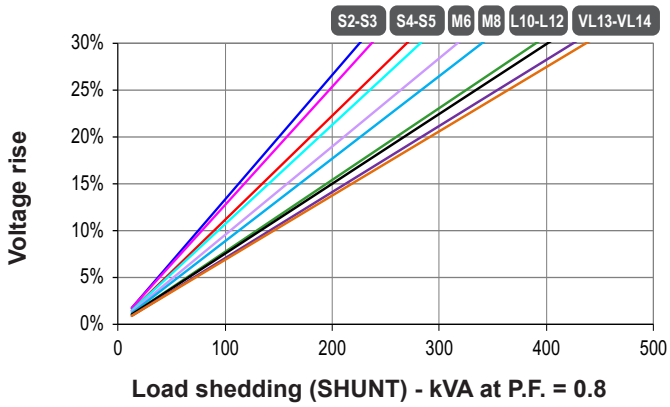
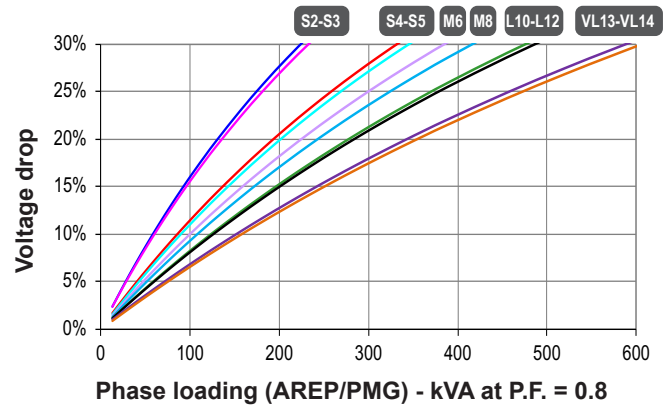
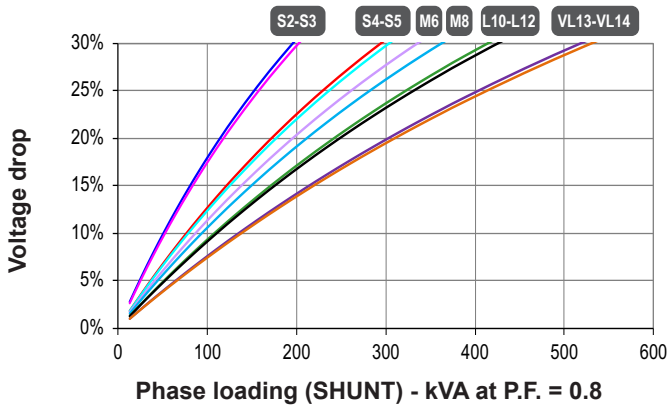

1) For a starting P.F. other than 0.6, the starting kVA must be multiplied by $K = \text{Sine P.F.} / 0.8$
 2) For voltages other than 400V (Y), 230V (Δ) at 50 Hz, then kVA must be multiplied by $(400/U)^2$ or $(230/U)^2$.

Transient voltage variation 480V - 60 Hz

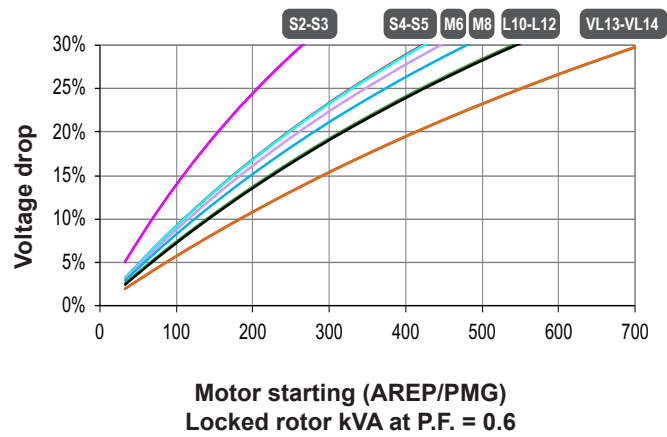
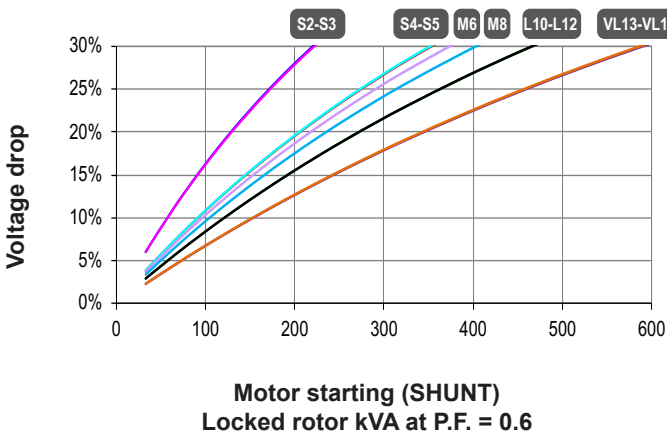
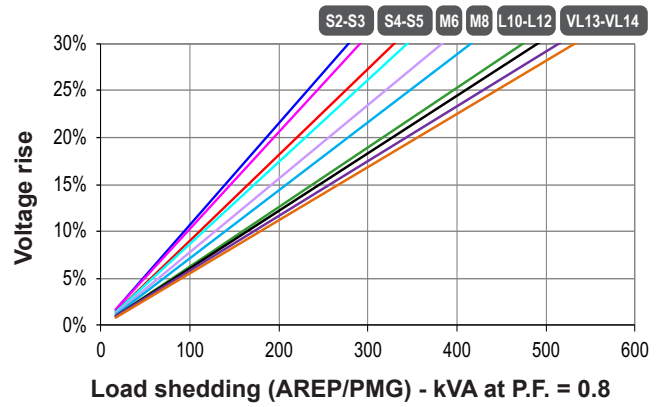
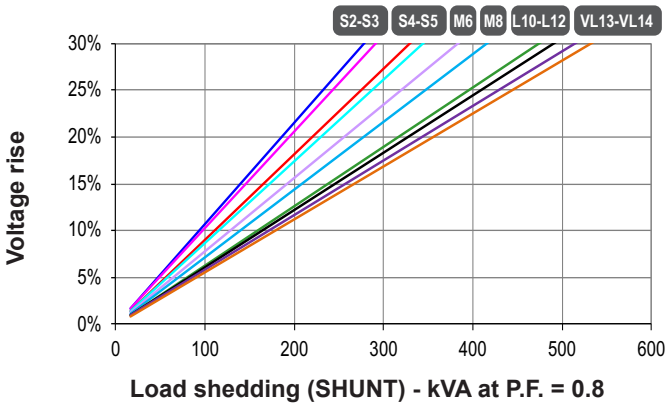
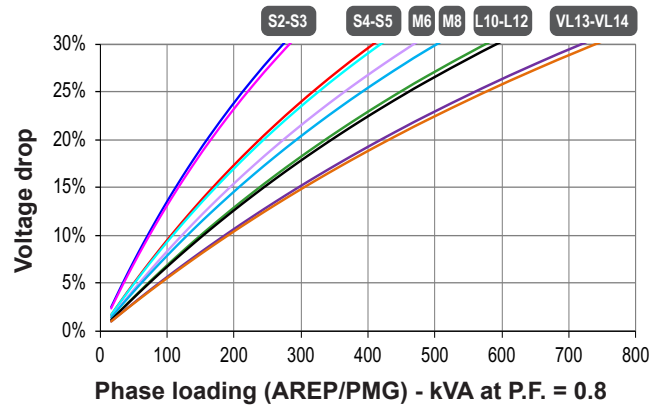
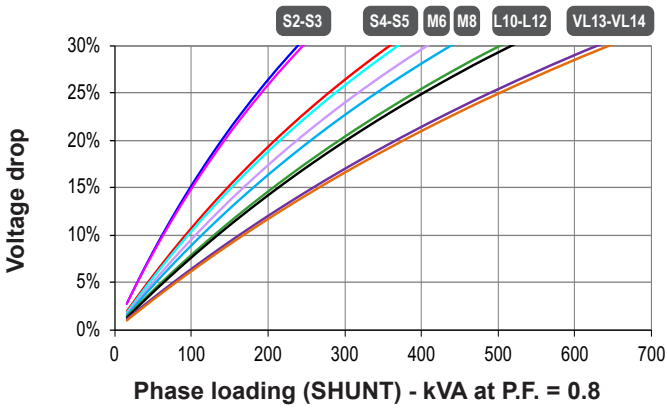

1) For a starting P.F. other than 0.6, the starting kVA must be multiplied by $K = \text{Sine P.F.} / 0.8$
 2) For voltages other than 480V (Y), 277V (Δ), 240V (YY) at 60 Hz, then kVA must be multiplied by $(480/U)^2$ or $(277/U)^2$ or $(240/U)^2$.

3-phase short-circuit curves at no load and rated speed (star connection Y)

LSA 44.3 S2

Symmetrical —
Asymmetrical - - -

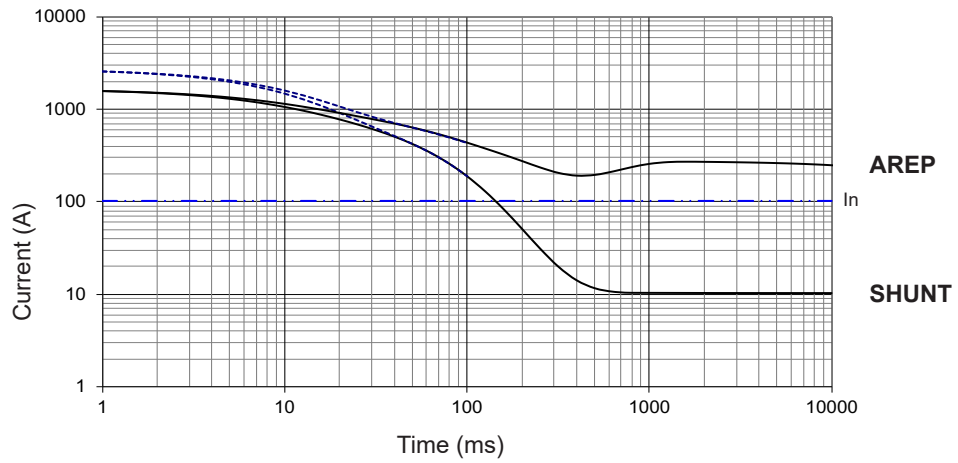

LSA 44.3 S3

Symmetrical —
Asymmetrical - - -

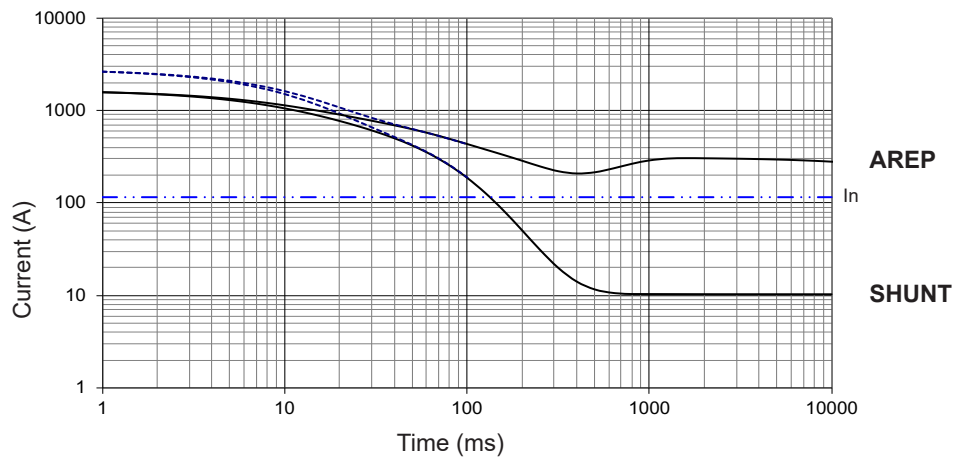

LSA 44.3 S4

Symmetrical —
Asymmetrical - - -

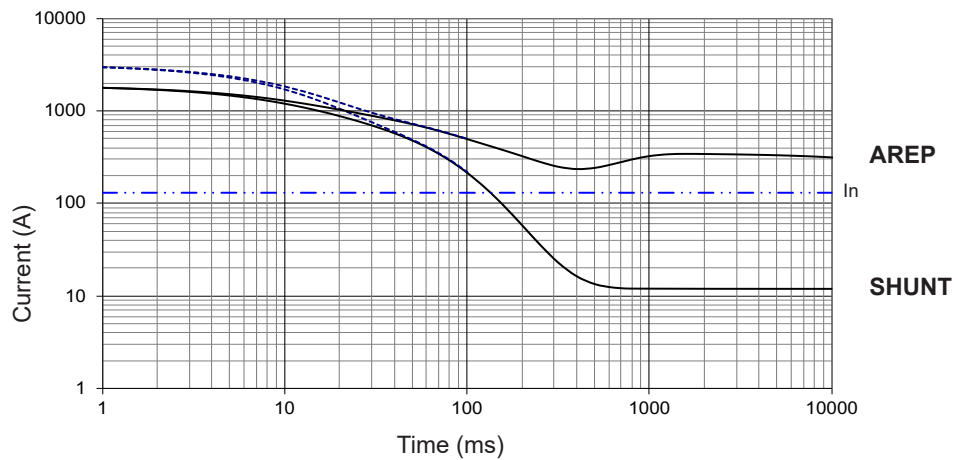

Influence due to connection

Curves shown are for star (Y) connection.

For other connections, use the following multiplication factors:

- Series delta : current value x 1.732 - Parallel star : current value x 2

3-phase short-circuit curves at no load and rated speed (star connection Y)

LSA 44.3 S5

Symmetrical —
Asymmetrical - - -

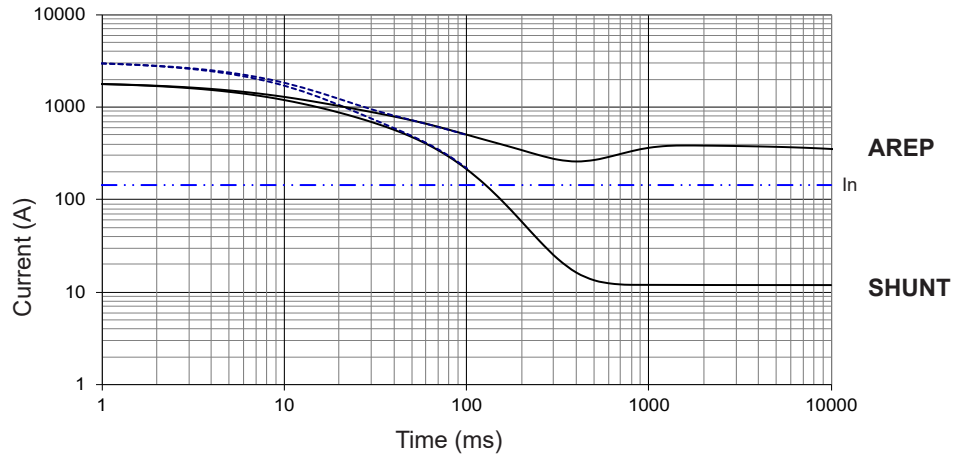

LSA 44.3 M6

Symmetrical —
Asymmetrical - - -

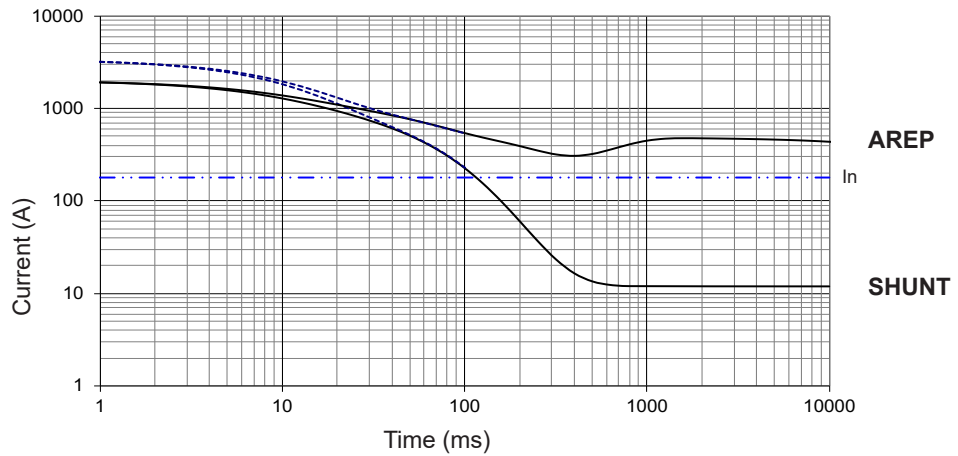

LSA 44.3 M8

Symmetrical —
Asymmetrical - - -

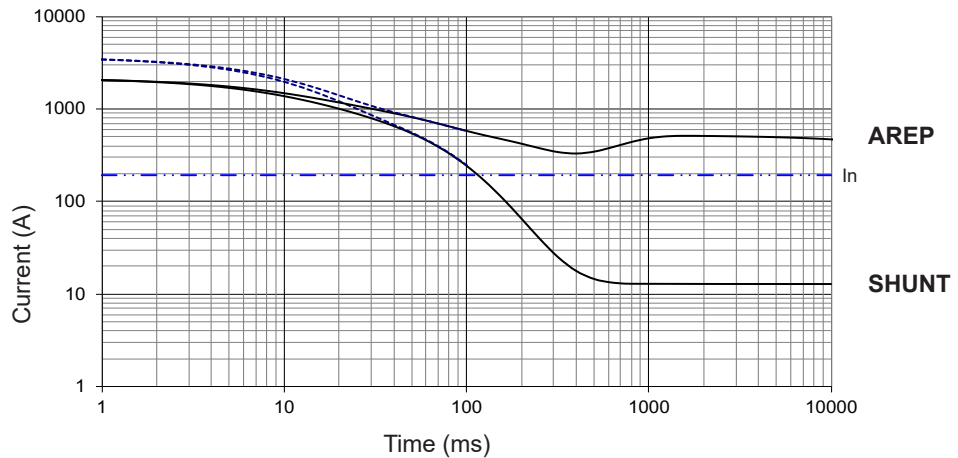

Influence due to short-circuit

Curves are based on a three-phase short-circuit.

For other types of short-circuit, use the following multiplication factors.

	3-phase	2-phase L/L	1-phase L/N
Instantaneous (max.)	1	0.87	1.3
Continuous	1	1.5	2.2
Maximum duration (AREP/PMG)	10 sec.	5 sec.	2 sec.

3-phase short-circuit curves at no load and rated speed (star connection Y)

LSA 44.3 L10

Symmetrical —
Asymmetrical - - -

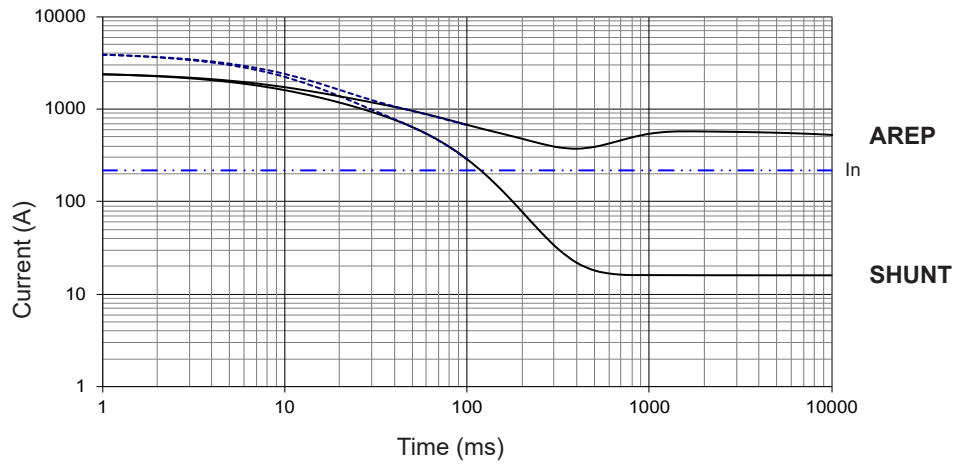

LSA 44.3 L12

Symmetrical —
Asymmetrical - - -

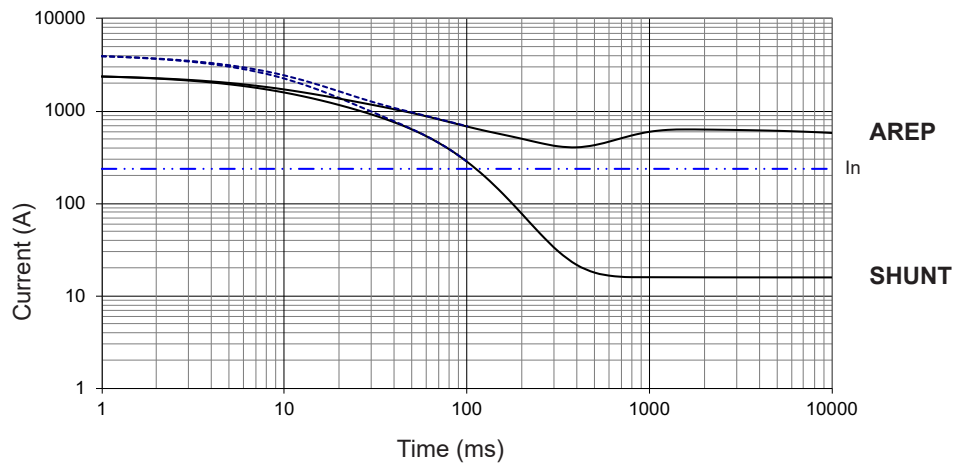

Influence due to connection

Curves shown are for star (Y) connection.

For other connections, use the following multiplication factors:

- Series delta : current value x 1.732 - Parallel star : current value x 2

3-phase short-circuit curves at no load and rated speed (star connection Y)

LSA 44.3 VL13

Symmetrical —
Asymmetrical - - -

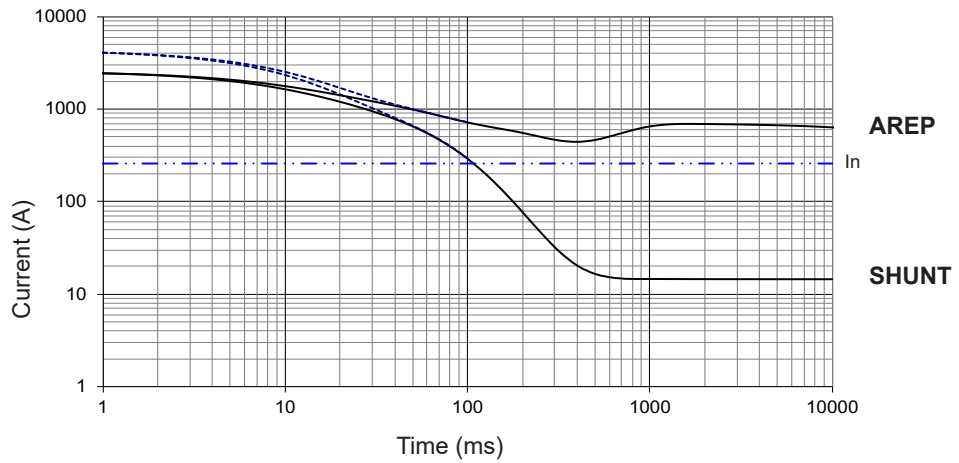

LSA 44.3 VL14

Symmetrical —
Asymmetrical - - -

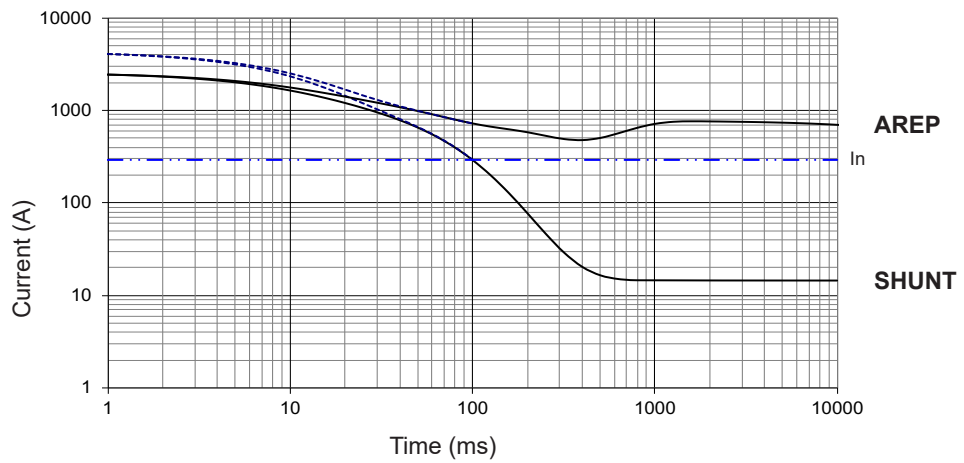

Influence due to short-circuit

Curves are based on a three-phase short-circuit.

For other types of short-circuit, use the following multiplication factors.

	3-phase	2-phase L/L	1-phase L/N
Instantaneous (max.)	1	0.87	1.3
Continuous	1	1.5	2.2
Maximum duration (AREP/PMG)	10 sec.	5 sec.	2 sec.

Single-bearing dimensions

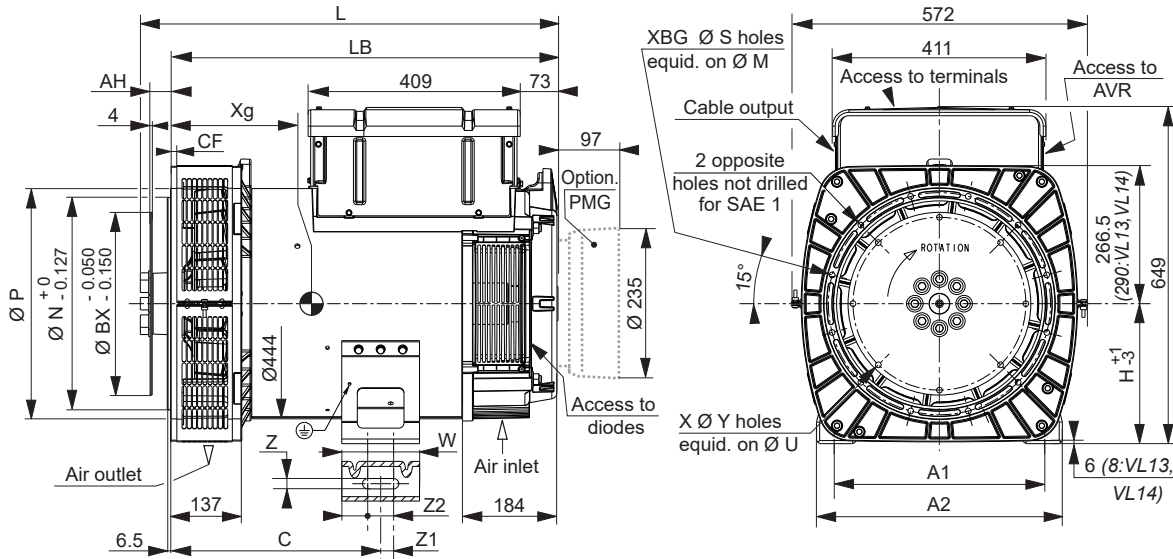

Dimensions (mm) and weight				
Type	L without PMG maxi*	LB	Xg	Weight (kg)
LSA 44.3 S2	758	677	313	295
LSA 44.3 S3	758	677	313	295
LSA 44.3 S4	758	677	329	332
LSA 44.3 S5	758	677	329	332
LSA 44.3 M6	828	747	353	368
LSA 44.3 M8	828	747	365	398
LSA 44.3 L10	868	787	383	433
LSA 44.3 L12	868	787	383	433
LSA 44.3 VL13	953	872	416	554
LSA 44.3 VL14	953	872	416	554

* L maxi = LB + AH maxi + 19

Flange (mm)						
S.A.E.	P	N	M	S	XBG	CF
4	400	361.95	381	11	12	16
3	445	409.58	428.62	11	12	16
2	485	447.68	466.72	11	12	16
1	560.5/581*	511.18	530.23	12	10	4.5/10*

* Specific dimension LSA 44.3 VL13 and VL14

Shaft height (mm)			
	Standard	Option	
H	270	225*	280**
Feet length			
C	405	332.5	429
A1	406	356	457
A2	474	430	541
Z	20	14.5	20
Z1	25	20	25
Z2	50	40	50
W	150	120	150

* Not available for VL13 and VL14
** Available only for VL13 and VL14

Coupling				
Flange	1	2	3	4
14	x	-	-	-
11 1/2	x	x	x	-
10	x	x	x	x
8	-	-	x	x

Flex plate (mm)					
S.A.E.	BX	U	X	Y	AH
14	466.72	438.15	8	14	25.4
11 1/2	352.42	333.38	8	11	39.6
10	314.32	295.28	8	11	53.8
8	263.52	244.48	6	11	62

Torsional analysis data

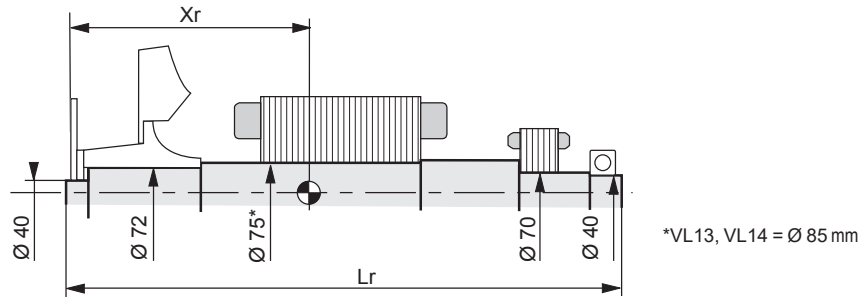

Centre of gravity: Xr (mm), Rotor length: Lr (mm), Weight: M (kg), Moment of inertia: J (kgm²): (4J = MD²)																
Flex plate	S.A.E. 8				S.A.E. 10				S.A.E. 11 1/2				S.A.E. 14			
	Xr	Lr	M	J	Xr	Lr	M	J	Xr	Lr	M	J	Xr	Lr	M	J
LSA 44.3 S2	362	729	121	0.855	353	729	121	0.868	322	729	127	0.883	318	729	123	1.007
LSA 44.3 S3	362	729	121	0.855	353	729	121	0.868	322	729	127	0.883	318	729	123	1.007
LSA 44.3 S4	383	729	139	1.013	372	729	139	1.026	359	729	138	1.041	337	729	141	1.165
LSA 44.3 S5	383	729	139	1.013	372	729	139	1.026	359	729	138	1.041	337	729	141	1.165
LSA 44.3 M6	408	799	154	1.129	399	799	154	1.142	386	799	153	1.157	364	799	156	1.281
LSA 44.3 M8	418	799	165	1.236	410	799	165	1.249	397	799	165	1.264	373	799	168	1.388
LSA 44.3 L10	438	839	181	1.371	429	839	181	1.384	417	839	180	1.399	397	839	183	1.523
LSA 44.3 L12	437	839	181	1.381	428	839	181	1.394	416	839	181	1.409	396	839	184	1.533
LSA 44.3 VL13	473	922.4	224	1.739	465	914	224	1.753	451	899	224	1.769	436.5	906	231	1.899
LSA 44.3 VL14	473	922.4	224	1.739	465	914	224	1.753	451	899	224	1.769	436.5	906	231	1.899

NOTE : Dimensions are for information only and may be subject to modifications. Contractual 2D drawings can be downloaded from the Leroy-Somer site, 3D drawing files are available upon request. The torsional analysis of the transmission is imperative. All values are available upon request.

Two-bearing dimensions

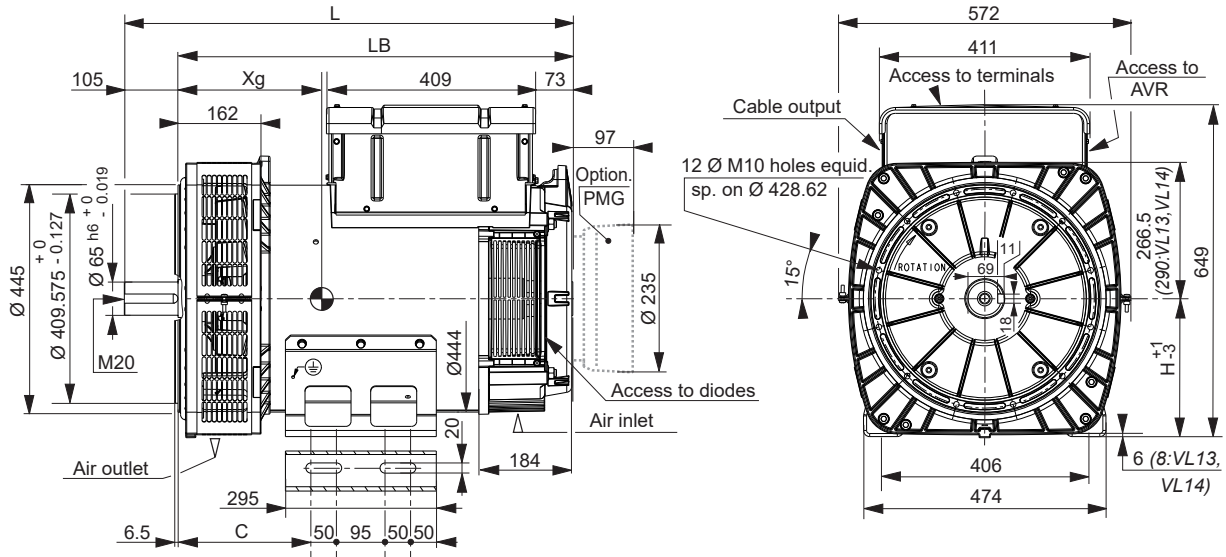

Dimensions (mm) and weight

Type	L without PMG	LB	Xg	C	H*	Weight (kg)
LSA 44.3 S2	807	702	333	260	270	301
LSA 44.3 S3	807	702	333	260	270	301
LSA 44.3 S4	807	702	350	260	270	338
LSA 44.3 S5	807	702	350	260	270	338
LSA 44.3 M6	877	772	373	260	270	374
LSA 44.3 M8	877	772	385	260	270	404
LSA 44.3 L10	917	812	403	260	270	439
LSA 44.3 L12	917	812	393	260	270	439
LSA 44.3 VL13	1002	897	422	285	270	555
LSA 44.3 VL14	1002	897	422	285	270	555

* H options: 225 mm, not available for VL13 and VL14, or 280 mm, available only for VL13 and VL14. Drawing available upon request.

Torsional analysis data

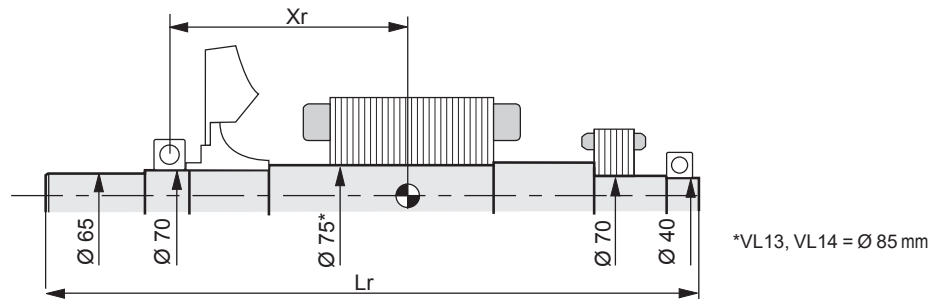

Centre of gravity: Xr (mm), Rotor length: Lr (mm), Weight: M (kg), Moment of inertia: J (kgm²): (4J = MD²)

Type	Xr	Lr	M	J
LSA 44.3 S2	309	793	117	0.825
LSA 44.3 S3	309	793	117	0.825
LSA 44.3 S4	329	793	135	0.988
LSA 44.3 S5	329	793	135	0.988
LSA 44.3 M6	353	863	149	1.096
LSA 44.3 M8	363	863	161	1.203
LSA 44.3 L10	383	903	176	1.346
LSA 44.3 L12	382	903	177	1.356
LSA 44.3 VL13	409	988	219.5	1.706
LSA 44.3 VL14	409	988	219.5	1.706

NOTE : Dimensions are for information only and may be subject to modifications. Contractual 2D drawings can be downloaded from the Leroy-Somer site, 3D drawing files are available upon request. The torsional analysis of the transmission is imperative. All values are available upon request.

LEROY-SOMER[™]

www.leroy-somer.com/epg

Connect with us at:



Nidec
All for dreams

© 2022 Moteurs Leroy-Somer SAS. The information contained in this brochure is for guidance only and does not form part of any contract. The accuracy cannot be guaranteed as Moteurs Leroy-Somer SAS have an ongoing process of development and reserve the right to change the specification of their products without notice.

Moteurs Leroy-Somer SAS. Headquarters: Bd Marcellin Leroy, CS 10015, 16915 Angoulême Cedex 9, France. Share Capital: 38,679,664 €, RCS Angoulême 338 567 258.