

*ALTERNATOR DATASHEET*

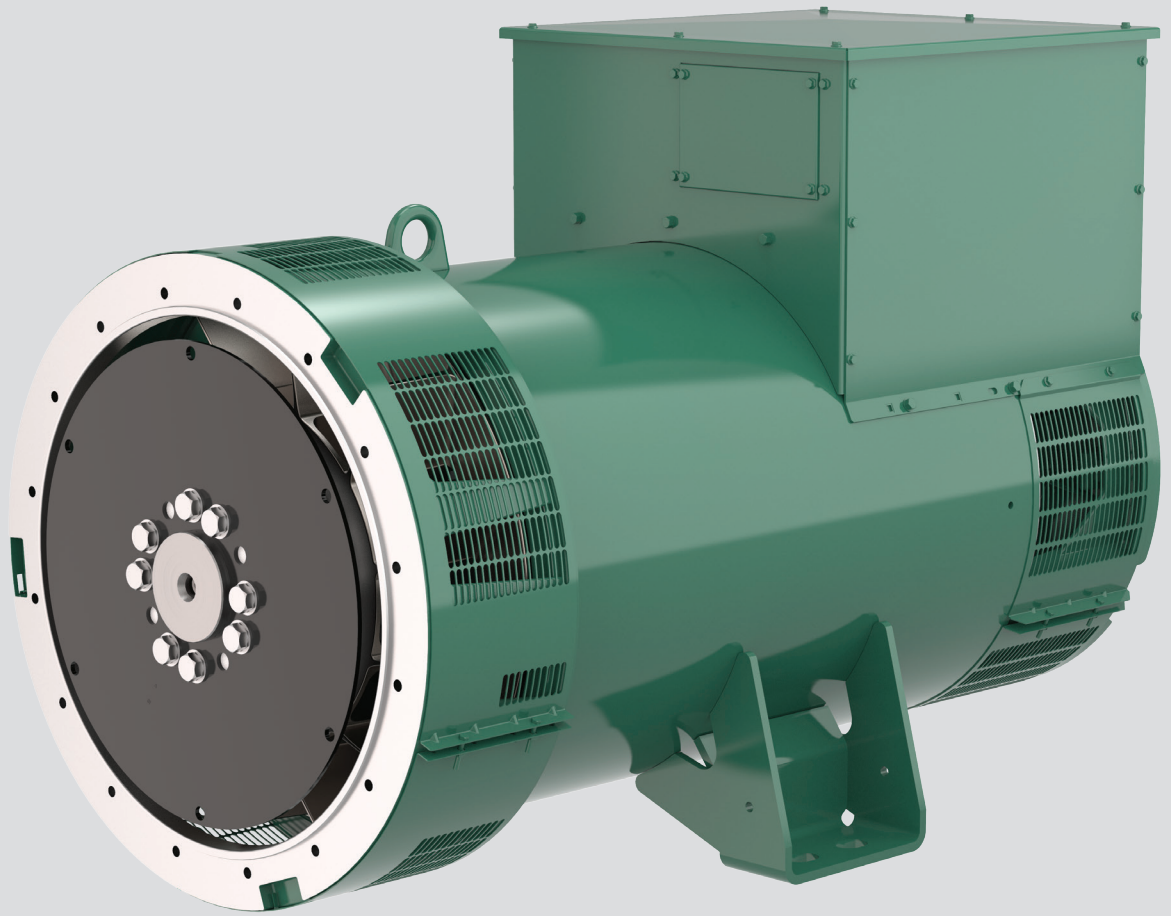



## LSA 49.3

### Low Voltage Alternator - 4 pole

660 to 1000 kVA - 50 Hz / 825 to 1250 kVA - 60 Hz  
Electrical and mechanical data

**LEROY-SOMER**™

***Nidec***  
All for dreams

## The best of performance

Nidec Leroy-Somer LSA 49.3 alternator has been designed to offer you the best power generation performances. With its meticulous design and optimized architecture, the LSA 49.3 strikes the perfect balance between compactness, reliability, performance and longevity.

Whatever your application, the LSA 49.3 will meet your needs and will adapt to all situations.

## Standards

Nidec Leroy-Somer LSA 49.3 alternator meets all key international standards and regulations, including IEC 60034, NEMA MG 1.32-33, ISO 8528-3, CSA C22.2 n°100-14 and UL 1446 (UL 1004 on request). Also compliant with IEC 61000-6-2, IEC 61000-6-3, IEC 61000-6-4, VDE 0875G, VDE 0875N and EN 55011, group 1 class A for European zone.

Nidec Leroy-Somer LSA 49.3 alternator can be integrated in EC marked generator set, and bears EC and CMIM markings. It is designed, manufactured and marketed in an ISO 9001 and ISO 14001 quality assurance environment.

## Electrical characteristics and performances

- Class H insulation
- 2/3 pitch winding, standard 6-wire (6S) reconnectable or 12-wire (6) optional
- Voltage range:
  - 50 Hz: 220V - 240V and 380V - 415V (440V)
  - 60 Hz: 208V - 240V and 380V - 480V
- High efficiency and motor starting capacity
- Other voltages are possible with optional adapted windings:
  - 50 Hz: 440V (no. 7), 500V (no. 9), 550V (no. 22), 600V (no. 23), 690V (no. 10)
  - 60 Hz: 380V and 416V (no. 8), 600V (no. 9), 690V (no. 22)

## Excitation and regulation system

| Excitation system |          |                 | Regulation options                             |                      |                                 |
|-------------------|----------|-----------------|--|----------------------|---------------------------------|
| AVR               | AREP     | PMG<br>(option) | C.T.<br>Current transformer<br>for paralleling | Mains<br>paralleling | Remote voltage<br>potentiometer |
| D350              | Standard | Standard        | √  |                      | √                               |
| D550              | Option   | Option          | √  | √                    | √                               |

3-phase sensing is included as a standard with digital regulators.

## Protection system and options

- The LSA 49.3 is IP 23
- Complete winding protection for clean environments with relative humidity  $\leq 95\%$ , including indoor marine environments
- Options:
  - Filters on air inlet: derating 5%
  - Filters on air inlet and air outlet (IP 44): derating 10%
  - Reinforced winding protection for harsh environments and relative humidity greater than 95%
  - Space heater
  - Thermal protection for stator windings and shields

## Mechanical construction

- Compact and rigid assembly to better withstand generator vibrations
- Steel frame
- Cast iron flanges and shields
- Two-bearing and single-bearing versions designed to be suitable for engines on the market
- Half-key balancing
- Greased for life bearings, regreasable bearings (optional)
- Standard direction of rotation: clockwise when looking at the drive end view (for anti-clockwise, derate the machine by 5%)

## Terminal box design

- Easy access to the voltage regulator and to the connections
- Possible inclusion of accessories for paralleling, protection and measurement
- Connection bars for voltage reconnection

# LSA 49.3 - 660 to 1000 kVA - 50 Hz / 825 to 1250 kVA - 60 Hz

## General characteristics

|                  |   |                                    |                                |
|------------------|---|------------------------------------|--------------------------------|
| Insulation class | H   | Excitation system                  | AREP / PMG                     |
| Winding pitch    | 2/3 (wind.6S - 6-wire / wind.6 - 12-wire option)            | AVR type                           | D350                           |
| Number of wires  | 6 (12 option)   | Voltage regulation (*)             | ± 0.25%                        |
| Protection       | IP 23   | Short-circuit current              | 300% (3 IN) : 10s              |
| Altitude         | ≤ 1000 m  | Total Harmonic distortion THD (**) | at no load < 4% - on load < 4% |
| Overspeed        | 2250 R.P.M.   | Waveform: NEMA = TIF (**)          | < 50                           |
| Air flow         | 1 m <sup>3</sup> /s (50 Hz) / 1.2 m <sup>3</sup> /s (60 Hz) | Waveform: IEC = THF (**)           | < 2%                           |

(\*) Steady state (\*\*) Total harmonic distortion between phases, no-load or on-load (non-distorting)

## Ratings 50 Hz - 1500 R.P.M.

| kVA / kW - P.F. = 0.8   |                      |             |      |      |                      |             |      |      |               |             |      |      |               |             |      |      |
|-------------------------|----------------------|-------------|------|------|----------------------|-------------|------|------|---------------|-------------|------|------|---------------|-------------|------|------|
| Duty/T°C                | Continuous duty/40°C |             |      |      | Continuous duty/40°C |             |      |      | Stand-by/40°C |             |      |      | Stand-by/27°C |             |      |      |
| Class/T°K               | H/125°K              |             |      |      | F/105°K              |             |      |      | H/150°K       |             |      |      | H/163°K       |             |      |      |
| Phase                   | 3 ph.                |             |      |      | 3 ph.                |             |      |      | 3 ph.         |             |      |      | 3 ph.         |             |      |      |
| <b>Y</b>                | 380V                 | <b>400V</b> | 415V | 440V | 380V                 | <b>400V</b> | 415V | 440V | 380V          | <b>400V</b> | 415V | 440V | 380V          | <b>400V</b> | 415V | 440V |
| <b>Δ</b>                | 220V                 | <b>230V</b> | 240V |      | 220V                 | <b>230V</b> | 240V |      | 220V          | <b>230V</b> | 240V |      | 220V          | <b>230V</b> | 240V |      |
| <b>YY</b>               |                      | <b>200V</b> | 220V |      |                      | <b>200V</b> | 220V |      |               | <b>200V</b> | 220V |      |               | <b>200V</b> | 220V |      |
| <b>LSA 49.3 S4</b> kVA  | 660                  | <b>660</b>  | 660  | 620  | 595                  | <b>595</b>  | 595  | 560  | 725           | <b>725</b>  | 725  | 685  | 745           | <b>745</b>  | 745  | 715  |
| kW                      | 528                  | <b>528</b>  | 528  | 496  | 476                  | <b>476</b>  | 476  | 448  | 580           | <b>580</b>  | 580  | 548  | 596           | <b>596</b>  | 596  | 572  |
| <b>LSA 49.3 M6</b> kVA  | 730                  | <b>730</b>  | 730  | 665  | 660                  | <b>660</b>  | 660  | 600  | 780           | <b>780</b>  | 780  | 730  | 810           | <b>810</b>  | 810  | 765  |
| kW                      | 584                  | <b>584</b>  | 584  | 532  | 528                  | <b>528</b>  | 528  | 480  | 624           | <b>624</b>  | 624  | 584  | 648           | <b>648</b>  | 648  | 612  |
| <b>LSA 49.3 M8</b> kVA  | 820                  | <b>820</b>  | 820  | 810  | 760                  | <b>760</b>  | 760  | 710  | 910           | <b>910</b>  | 910  | 885  | 945           | <b>945</b>  | 945  | 925  |
| kW                      | 656                  | <b>656</b>  | 656  | 648  | 608                  | <b>608</b>  | 608  | 568  | 728           | <b>728</b>  | 728  | 708  | 756           | <b>756</b>  | 756  | 740  |
| <b>LSA 49.3 L9</b> kVA  | 910                  | <b>910</b>  | 910  | 820  | 820                  | <b>820</b>  | 820  | 740  | 1000          | <b>1000</b> | 1000 | 920  | 1020          | <b>1020</b> | 1020 | 965  |
| kW                      | 728                  | <b>728</b>  | 728  | 656  | 656                  | <b>656</b>  | 656  | 592  | 800           | <b>800</b>  | 800  | 736  | 816           | <b>816</b>  | 816  | 772  |
| <b>LSA 49.3 L10</b> kVA | 1000                 | <b>1000</b> | 1000 | 950  | 900                  | <b>900</b>  | 900  | 840  | 1085          | <b>1085</b> | 1085 | 1030 | 1130          | <b>1130</b> | 1130 | 1080 |
| kW                      | 800                  | <b>800</b>  | 800  | 760  | 720                  | <b>720</b>  | 720  | 672  | 868           | <b>868</b>  | 868  | 824  | 904           | <b>904</b>  | 904  | 864  |

## Ratings 60 Hz - 1800 R.P.M.

| kVA / kW - P.F. = 0.8   |                      |             |            |             |                      |      |      |             |               |      |      |             |               |      |      |             |
|-------------------------|----------------------|-------------|------------|-------------|----------------------|------|------|-------------|---------------|------|------|-------------|---------------|------|------|-------------|
| Duty/T°C                | Continuous duty/40°C |             |            |             | Continuous duty/40°C |      |      |             | Stand-by/40°C |      |      |             | Stand-by/27°C |      |      |             |
| Class/T°K               | H/125°K              |             |            |             | F/105°K              |      |      |             | H/150°K       |      |      |             | H/163°K       |      |      |             |
| Phase                   | 3 ph.                |             |            |             | 3 ph.                |      |      |             | 3 ph.         |      |      |             | 3 ph.         |      |      |             |
| <b>Y</b>                | 380V                 | 416V        | 440V       | <b>480V</b> | 380V                 | 416V | 440V | <b>480V</b> | 380V          | 416V | 440V | <b>480V</b> | 380V          | 416V | 440V | <b>480V</b> |
| <b>Δ</b>                | 220V                 | 240V        |            |             | 220V                 | 240V |      |             | 220V          | 240V |      |             | 220V          | 240V |      |             |
| <b>YY</b>               |                      | <b>208V</b> | 220V       | <b>240V</b> |                      | 208V | 220V | <b>240V</b> |               | 208V | 220V | <b>240V</b> |               | 208V | 220V | <b>240V</b> |
| <b>LSA 49.3 S4</b> kVA  | 653                  | 715         | 756        | <b>825</b>  | 588                  | 644  | 681  | <b>743</b>  | 693           | 758  | 802  | <b>875</b>  | 718           | 787  | 832  | <b>908</b>  |
| kW                      | 522                  | 572         | 605        | <b>660</b>  | 470                  | 515  | 545  | <b>594</b>  | 554           | 606  | 642  | <b>700</b>  | 574           | 630  | 666  | <b>726</b>  |
| <b>LSA 49.3 M6</b> kVA  | <b>725</b>           | <b>795</b>  | <b>840</b> | <b>915</b>  | 655                  | 715  | 760  | <b>825</b>  | 770           | 845  | 890  | <b>970</b>  | 800           | 875  | 925  | <b>1005</b> |
| kW                      | 580                  | 636         | 672        | <b>732</b>  | 524                  | 572  | 608  | <b>660</b>  | 616           | 676  | 712  | <b>776</b>  | 640           | 700  | 740  | <b>804</b>  |
| <b>LSA 49.3 M8</b> kVA  | 815                  | 890         | 940        | <b>1025</b> | 735                  | 805  | 850  | <b>925</b>  | 865           | 945  | 1000 | <b>1090</b> | 895           | 980  | 1040 | <b>1130</b> |
| kW                      | 652                  | 712         | 752        | <b>820</b>  | 588                  | 644  | 680  | <b>740</b>  | 692           | 756  | 800  | <b>872</b>  | 716           | 784  | 832  | <b>904</b>  |
| <b>LSA 49.3 L9</b> kVA  | 905                  | 990         | 1045       | <b>1140</b> | 815                  | 895  | 940  | <b>1025</b> | 960           | 1050 | 1110 | <b>1210</b> | 1000          | 1090 | 1155 | <b>1255</b> |
| kW                      | 724                  | 792         | 836        | <b>912</b>  | 652                  | 716  | 752  | <b>820</b>  | 768           | 840  | 888  | <b>968</b>  | 800           | 872  | 924  | <b>1004</b> |
| <b>LSA 49.3 L10</b> kVA | 990                  | 1083        | 1146       | <b>1250</b> | 891                  | 975  | 1031 | <b>1125</b> | 1049          | 1148 | 1215 | <b>1325</b> | 1089          | 1192 | 1260 | <b>1375</b> |
| kW                      | 792                  | 866         | 917        | <b>1000</b> | 713                  | 780  | 825  | <b>900</b>  | 839           | 918  | 972  | <b>1060</b> | 871           | 954  | 1008 | <b>1100</b> |

Efficiencies 400V - 50 Hz (— P.F.: 0.8) (--- P.F.: 1)

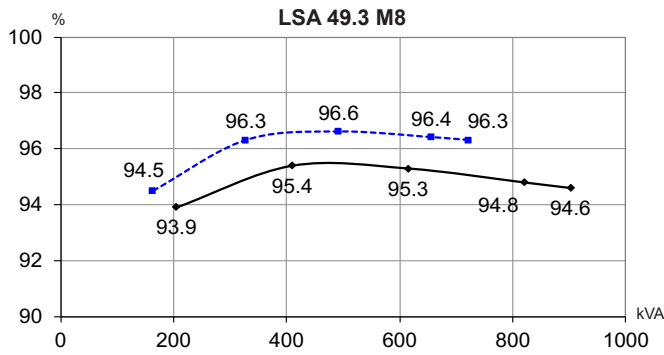
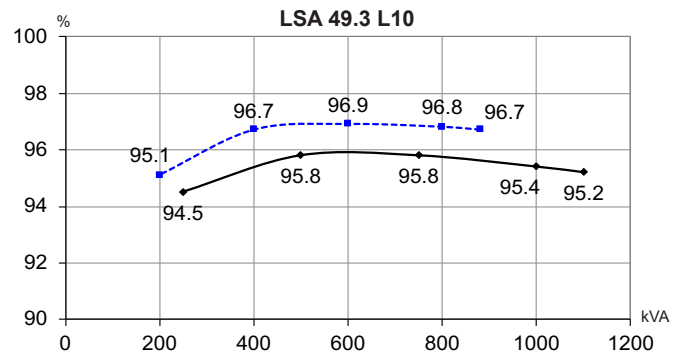
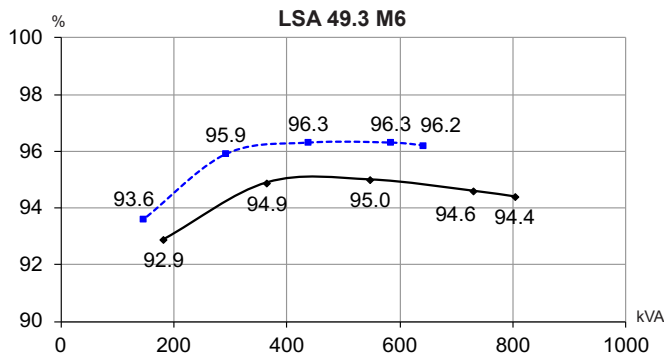
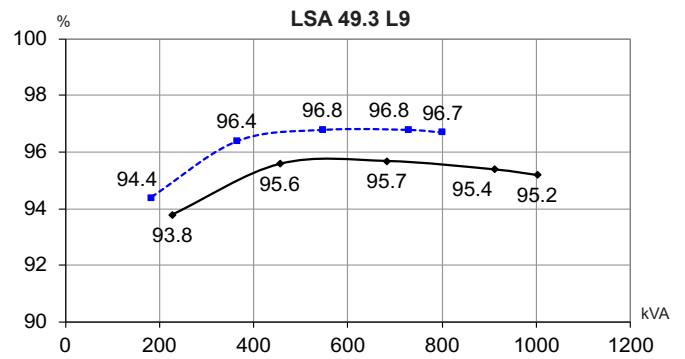
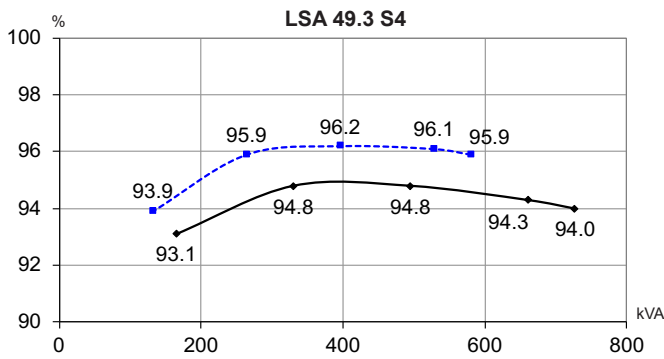

Reactances (%). Time constants (ms) - Class H / 400 V

|  | S4    | M6   | M8    | L9    | L10   |
|--|-------|------|-------|-------|-------|
| <b>Kcc</b> Short-circuit ratio                               | 0.33  | 0.42 | 0.34  | 0.41  | 0.34  |
| <b>Xd</b> Direct-axis synchronous reactance unsaturated      | 350   | 294  | 348   | 303   | 348   |
| <b>Xq</b> Quadrature-axis synchronous reactance unsaturated  | 178   | 150  | 177   | 154   | 177   |
| <b>T'do</b> No-load transient time constant                  | 2002  | 2074 | 2094  | 2138  | 2153  |
| <b>X'd</b> Direct-axis transient reactance saturated         | 17.5  | 14.2 | 16.6  | 14.1  | 16.1  |
| <b>T'd</b> Short-circuit transient time constant             | 100   | 100  | 100   | 100   | 100   |
| <b>X''d</b> Direct-axis subtransient reactance saturated     | 14    | 11.3 | 13.3  | 11.3  | 12.9  |
| <b>T''d</b> Subtransient time constant                       | 10    | 10   | 10    | 10    | 10    |
| <b>X''q</b> Quadrature-axis subtransient reactance saturated | 16.3  | 12.8 | 14.9  | 12.4  | 14.1  |
| <b>Xo</b> Zero sequence reactance                            | 0.72  | 0.59 | 0.69  | 0.59  | 0.67  |
| <b>X2</b> Negative sequence reactance saturated              | 15.17 | 12.1 | 14.11 | 11.92 | 13.53 |
| <b>Ta</b> Armature time constant                             | 15    | 15   | 15    | 15    | 15    |

Other class H / 400 V data

|  |       |       |       |       |       |
|--|-------|-------|-------|-------|-------|
| <b>io (A)</b> No-load excitation current                               | 0.99  | 1.11  | 0.87  | 0.99  | 0.9   |
| <b>ic (A)</b> On-load excitation current                               | 4.04  | 3.8   | 3.52  | 3.46  | 3.62  |
| <b>uc (V)</b> On-load excitation voltage                               | 46    | 43.2  | 39.9  | 39.1  | 40.9  |
| <b>ms</b> Response time ( $\Delta U = 20\%$ transient)                 | 500   | 500   | 500   | 500   | 500   |
| <b>kVA</b> Start ( $\Delta U = 20\%$ cont. or 30% trans.)              | 1560  | 2050  | 2050  | 2600  | 2600  |
| <b>%</b> Transient $\Delta U$ (on-load 4/4) - P.F.: 0.8 <sub>LAG</sub> | 14.4  | 12.6  | 14.2  | 12.2  | 13.6  |
| <b>W</b> No-load losses  | 7968  | 9374  | 8753  | 10104 | 9556  |
| <b>W</b> Heat dissipation  | 31765 | 32819 | 35599 | 34562 | 38447 |

Transient voltage variation 400V - 50 Hz

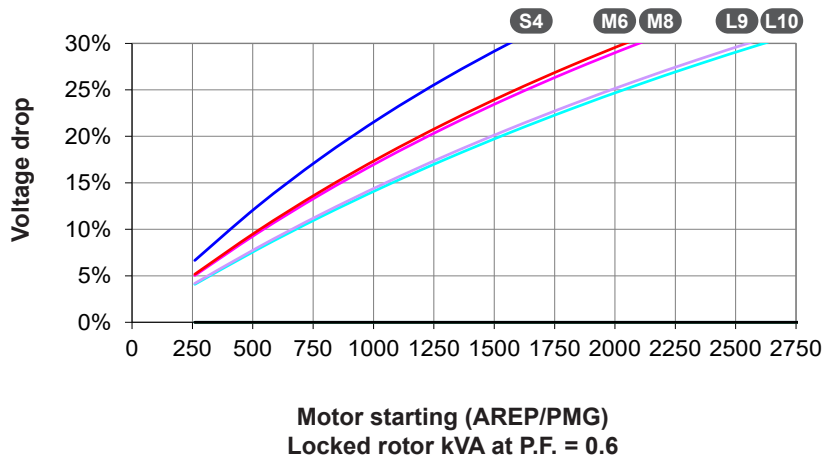
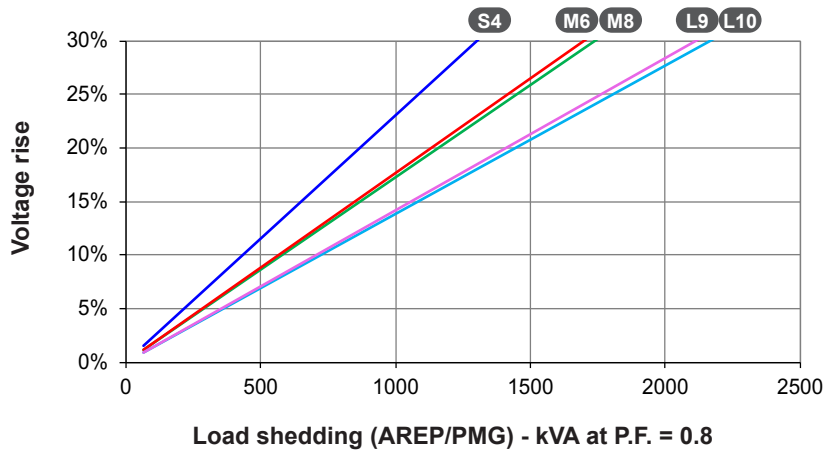
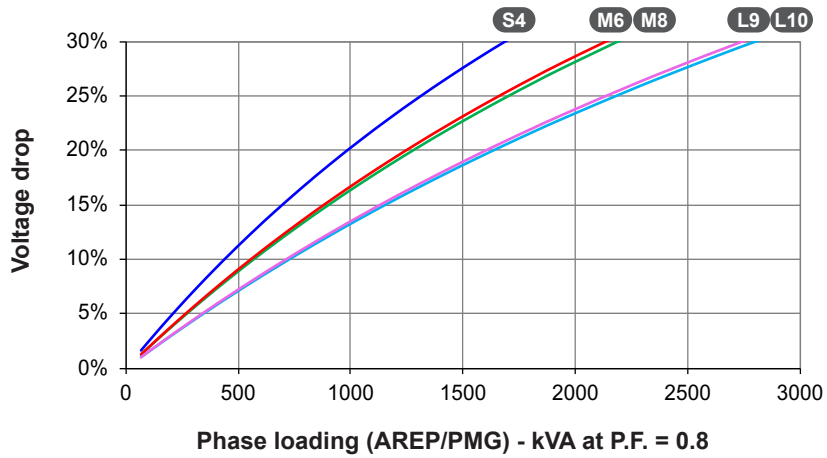

- 1) For a starting P.F. other than 0.6, the starting kVA must be multiplied by  $K = \text{Sine P.F.} / 0.8$
- 2) For voltages other than 400V (Y), 230V(Δ) at 50 Hz, then kVA must be multiplied by  $(400/U)^2$  or  $(230/U)^2$ .

Efficiencies 480V - 60 Hz (— P.F.: 0.8) (--- P.F.: 1)

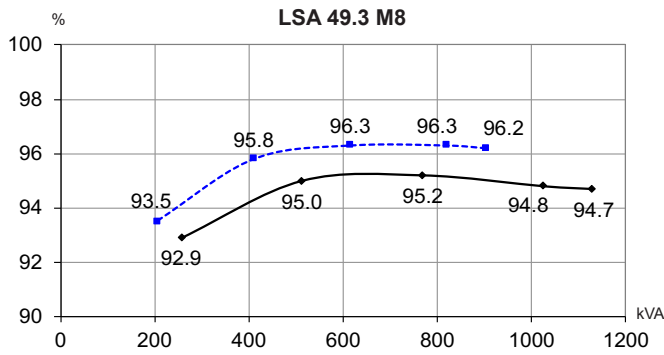
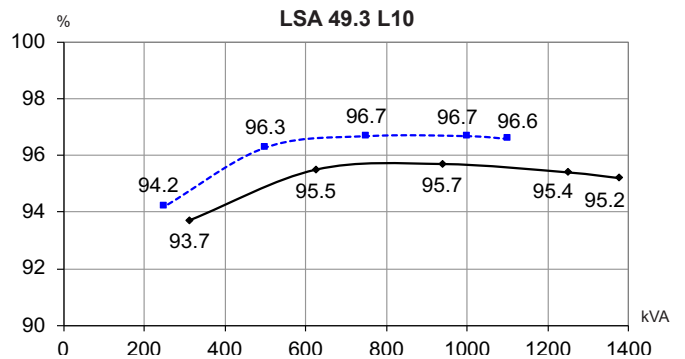
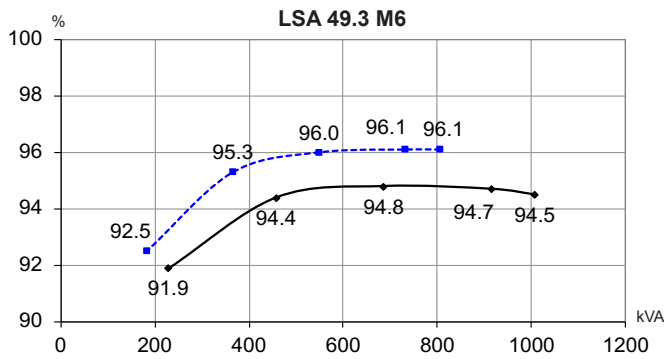
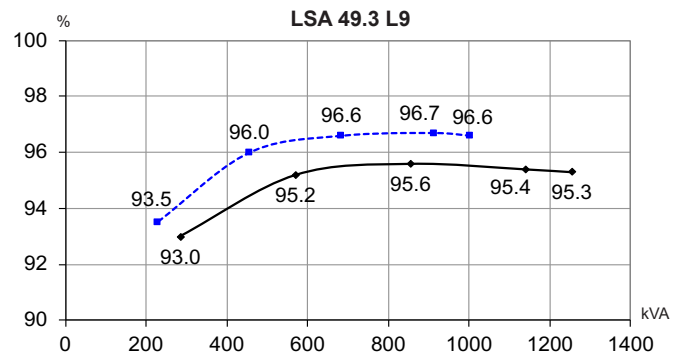
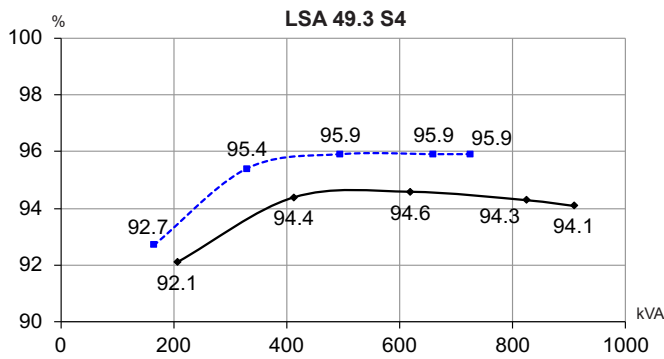

Reactances (%). Time constants (ms) - Class H / 480 V

|  | S4   | M6    | M8   | L9    | L10  |
|--|------|-------|------|-------|------|
| <b>Kcc</b> Short-circuit ratio                               | 0.32 | 0.4   | 0.32 | 0.4   | 0.33 |
| <b>Xd</b> Direct-axis synchronous reactance unsaturated      | 365  | 307   | 362  | 317   | 363  |
| <b>Xq</b> Quadrature-axis synchronous reactance unsaturated  | 186  | 156   | 185  | 161   | 185  |
| <b>T'do</b> No-load transient time constant                  | 2002 | 2074  | 2094 | 2138  | 2153 |
| <b>X'd</b> Direct-axis transient reactance saturated         | 18.2 | 14.8  | 17.3 | 14.8  | 16.8 |
| <b>T'd</b> Short-circuit transient time constant             | 100  | 100   | 100  | 100   | 100  |
| <b>X''d</b> Direct-axis subtransient reactance saturated     | 14.5 | 11.8  | 13.8 | 11.8  | 13.4 |
| <b>T''d</b> Subtransient time constant                       | 10   | 10    | 10   | 10    | 10   |
| <b>X''q</b> Quadrature-axis subtransient reactance saturated | 17   | 13.4  | 15.5 | 13    | 14.7 |
| <b>Xo</b> Zero sequence reactance                            | 0.76 | 0.61  | 0.72 | 0.61  | 0.7  |
| <b>X2</b> Negative sequence reactance saturated              | 15.8 | 12.64 | 14.7 | 12.44 | 14.1 |
| <b>Ta</b> Armature time constant                             | 15   | 15    | 15   | 15    | 15   |

Other class H / 480 V data

|  | S4    | M6    | M8    | L9    | L10   |
|--|-------|-------|-------|-------|-------|
| <b>io (A)</b> No-load excitation current                               | 0.99  | 1.11  | 0.87  | 0.99  | 0.9   |
| <b>ic (A)</b> On-load excitation current                               | 4.14  | 3.89  | 3.6   | 3.53  | 3.69  |
| <b>uc (V)</b> On-load excitation voltage                               | 47.3  | 44.4  | 41    | 40.2  | 41.9  |
| <b>ms</b> Response time ( $\Delta U = 20\%$ transient)                 | 500   | 500   | 500   | 500   | 500   |
| <b>kVA</b> Start ( $\Delta U = 20\%$ cont. or 30% trans.)              | 1950  | 2565  | 2565  | 3250  | 3250  |
| <b>%</b> Transient $\Delta U$ (on-load 4/4) - P.F.: 0.8 <sub>LAG</sub> | 14.9  | 13    | 14.7  | 12.7  | 14    |
| <b>W</b> No-load losses  | 12441 | 14387 | 13586 | 15384 | 14640 |
| <b>W</b> Heat dissipation  | 39236 | 40967 | 44074 | 43239 | 47530 |

Transient voltage variation 480V - 60 Hz

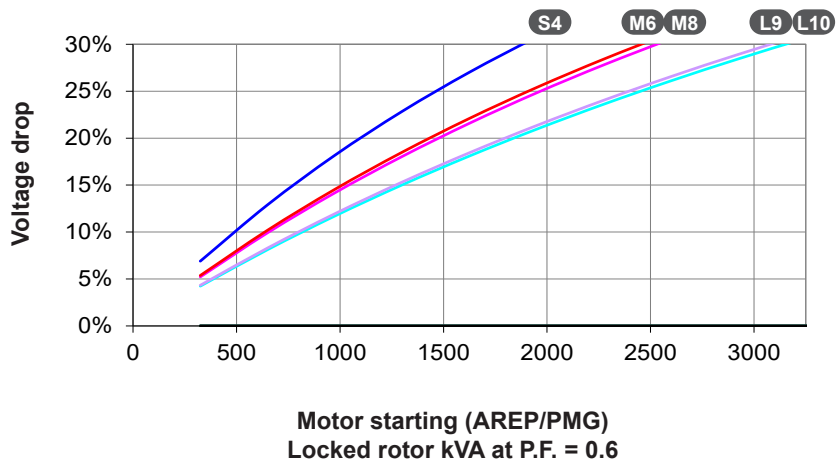
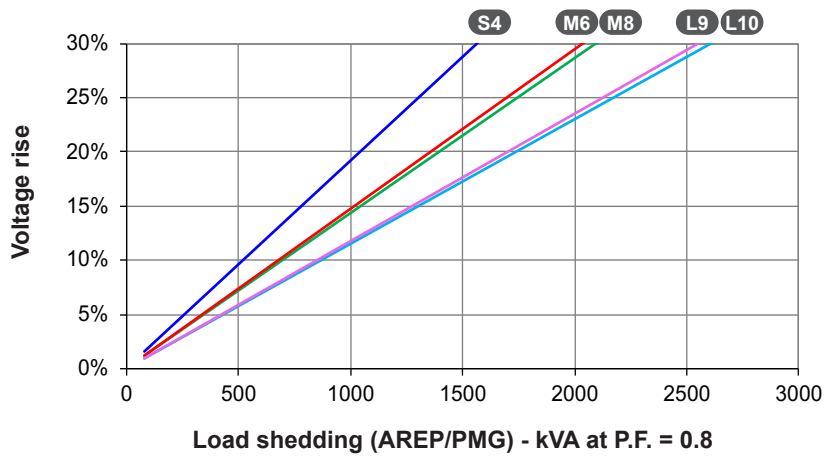
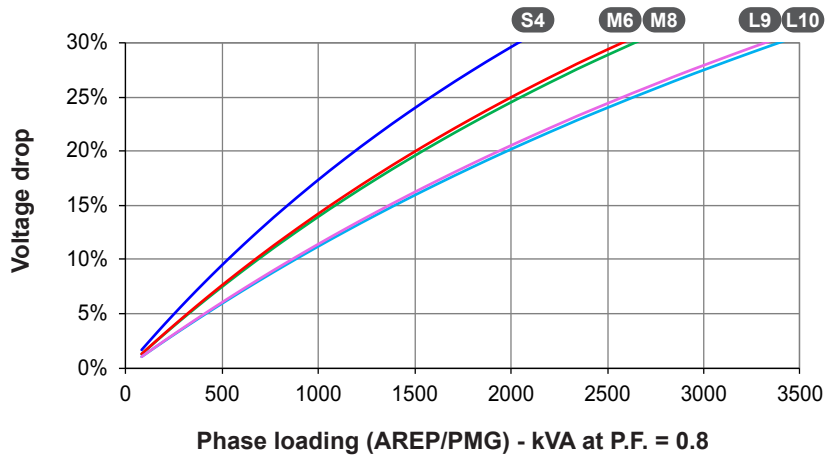

- 1) For a starting P.F. other than 0.6, the starting kVA must be multiplied by  $K = \text{Sine P.F.} / 0.8$
- 2) For voltages other than 480V (Y), 277V ( $\Delta$ ), 240V (YY) at 60 Hz, then kVA must be multiplied by  $(480/U)^2$  or  $(277/U)^2$  or  $(240/U)^2$ .



3-phase short-circuit curves at no load and rated speed (star connection Y)

LSA 49.3 S4

Symmetrical —  
Asymmetrical - - -

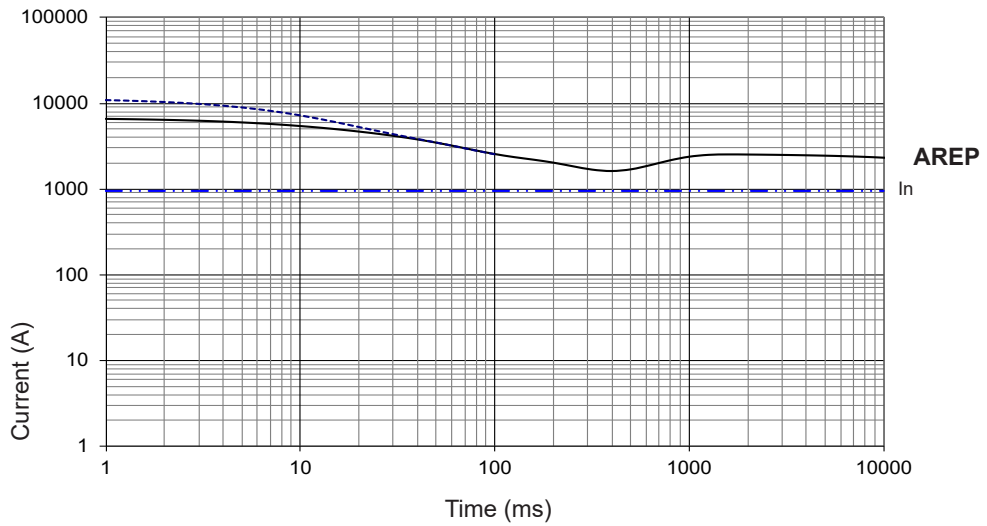

LSA 49.3 M6

Symmetrical —  
Asymmetrical - - -

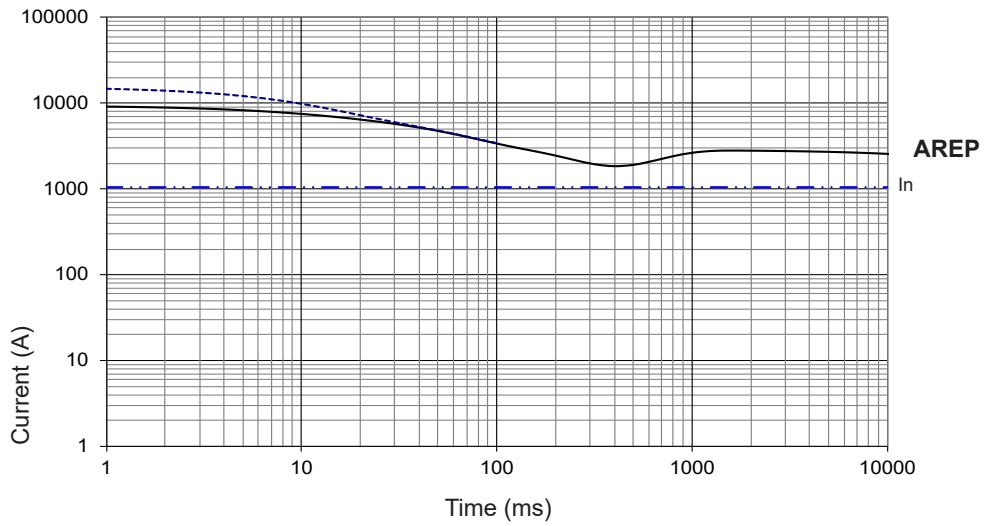

LSA 49.3 M8

Symmetrical —  
Asymmetrical - - -

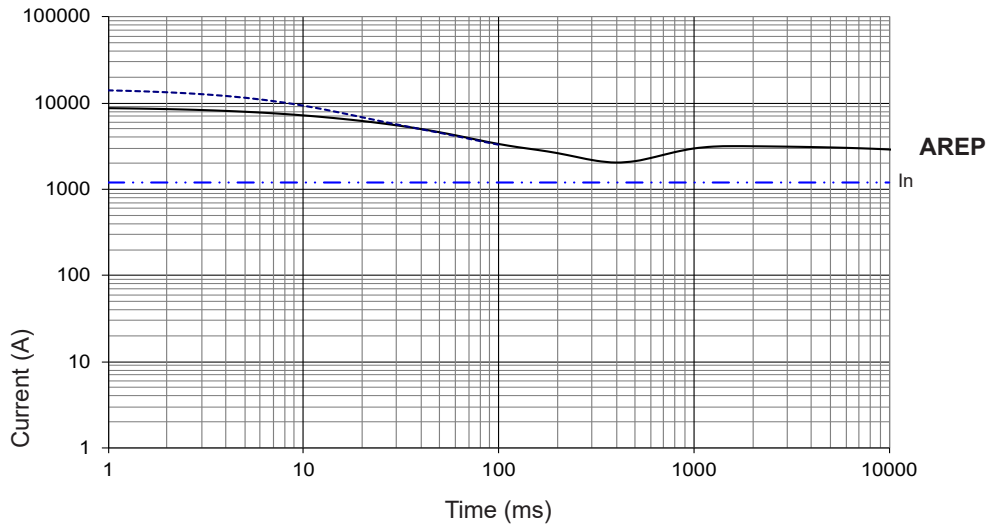

Influence due to connection

Curves shown are for star (Y) connection.

For other connections, use the following multiplication factors:

- Series delta : current value x 1.732 - Parallel star : current value x 2

3-phase short-circuit curves at no load and rated speed (star connection Y)

LSA 49.3 L9

Symmetrical —  
Asymmetrical - - -

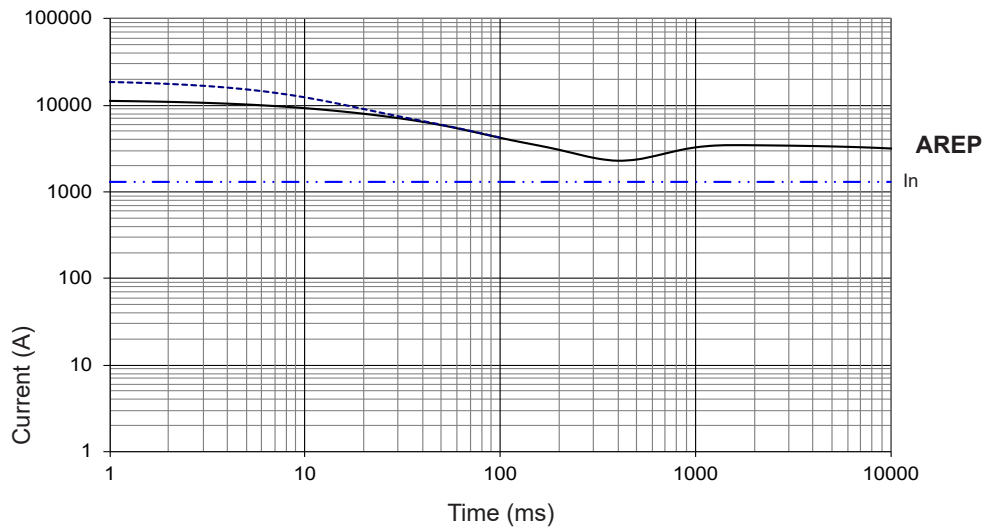

LSA 49.3 L10

Symmetrical —  
Asymmetrical - - -

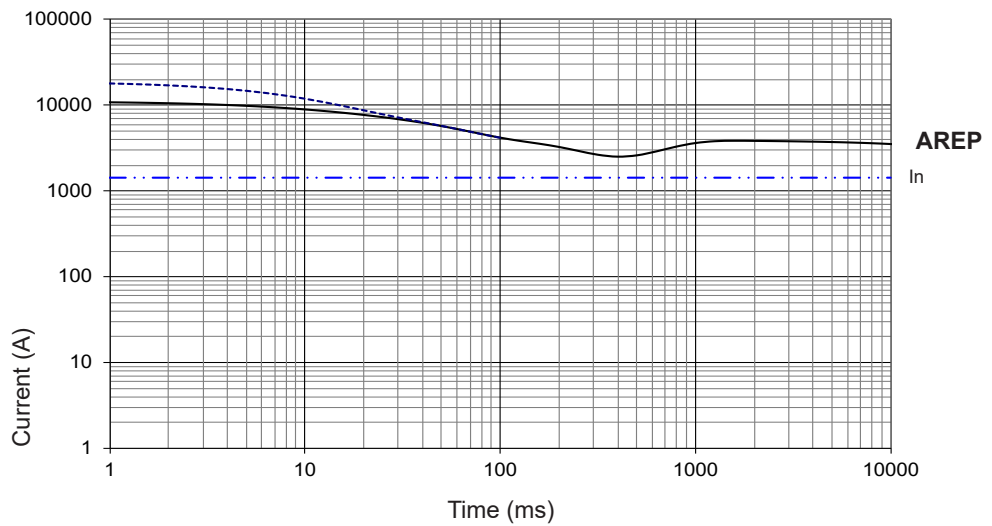

**Influence due to short-circuit**

Curves are based on a three-phase short-circuit.  
For other types of short-circuit, use the following multiplication factors.

|                             | 3-phase | 2-phase L/L | 1-phase L/N |
|-----------------------------|---------|-------------|-------------|
| Instantaneous (max.)        | 1       | 0.87        | 1.3         |
| Continuous                  | 1       | 1.5         | 2.2         |
| Maximum duration (AREP/PMG) | 10 sec. | 5 sec.      | 2 sec.      |

Single-bearing dimensions

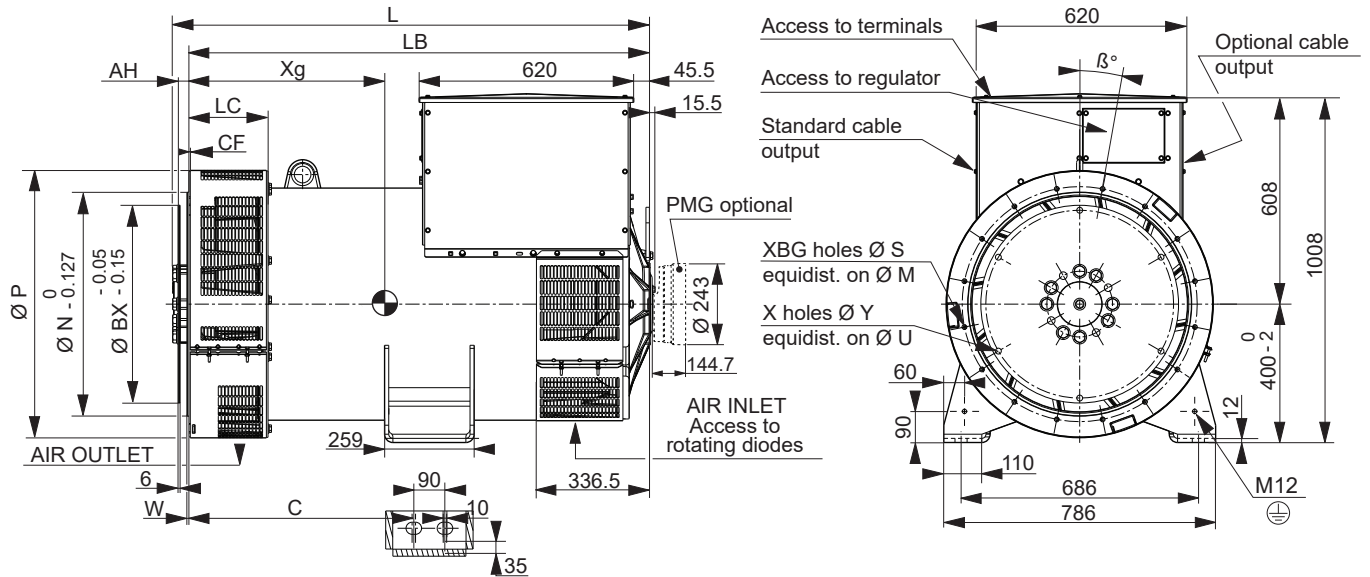

| Dimensions (mm) and weight |                     |      |     |     |             | Coupling         |    |    |
|----------------------------|---------------------|------|-----|-----|-------------|------------------|----|----|
| Type                       | L without PMG maxi* | LB   | C   | Xg  | Weight (kg) | Flex plate       | 14 | 18 |
| LSA 49.3 S4                | 1282                | 1241 | 560 | 590 | 1431        | Flange S.A.E 1   | X  |    |
| LSA 49.3 M6                | 1372                | 1331 | 650 | 629 | 1578        | Flange S.A.E 1/2 | X  |    |
| LSA 49.3 M8                | 1372                | 1331 | 650 | 636 | 1639        | Flange S.A.E 0   | X  | X  |
| LSA 49.3 L9                | 1462                | 1421 | 650 | 673 | 1792        | Flange S.A.E 00  |    | X  |
| LSA 49.3 L10               | 1462                | 1421 | 650 | 681 | 1841        |                  |    |    |

\* L maxi = LB + AH maxi + 15.5

| Flange (mm) |     |         |         |       |     |    |   |         |    | Flex plate (mm) |       |        |   |    |      |
|-------------|-----|---------|---------|-------|-----|----|---|---------|----|-----------------|-------|--------|---|----|------|
| S.A.E.      | P   | N       | M       | LC    | XBG | S  | W | β°      | CF | S.A.E.          | BX    | U      | X | Y  | AH   |
| 1           | 773 | 511.175 | 530.225 | 228.5 | 12  | 12 | 6 | 15°     | 38 | 14              | 466.7 | 438.15 | 8 | 14 | 25.4 |
| 1/2         | 773 | 584.2   | 619.125 | 228.5 | 12  | 14 | 6 | 15°     | 17 | 18              | 571.5 | 542.92 | 6 | 17 | 15.7 |
| 0           | 773 | 647.7   | 679.45  | 228.5 | 16  | 14 | 6 | 11° 15' | 37 |                 |       |        |   |    |      |
| 00          | 883 | 787.4   | 850.9   | 245   | 16  | 14 | 7 | 11° 15' | 40 |                 |       |        |   |    |      |

Torsional analysis data

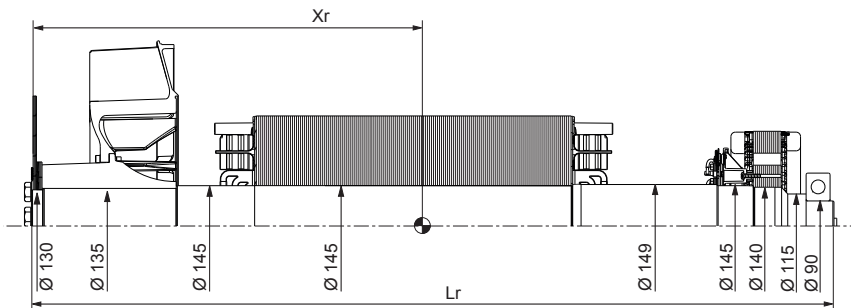

| Centre of gravity: Xr (mm), Rotor length: Lr (mm), Weight: M (kg), Moment of inertia: J (kgm²): (4J = MD²) |           |      |     |       |           |      |     |       |
|--|-----------|------|-----|-------|-----------|------|-----|-------|
| Flange   | S.A.E. 14 |      |     |       | S.A.E. 18 |      |     |       |
|  | Xr        | Lr   | M   | J     | Xr        | Lr   | M   | J     |
| LSA 49.3 S4  | 584       | 1255 | 539 | 8.51  | 572       | 1255 | 541 | 8.77  |
| LSA 49.3 M6  | 626       | 1345 | 602 | 9.61  | 614       | 1345 | 604 | 9.87  |
| LSA 49.3 M8  | 634       | 1345 | 628 | 10.16 | 622       | 1345 | 630 | 10.42 |
| LSA 49.3 L9  | 671       | 1435 | 684 | 11.12 | 659       | 1435 | 686 | 11.38 |
| LSA 49.3 L10   | 681       | 1435 | 701 | 11.48 | 669       | 1435 | 703 | 11.74 |

NOTE : Dimensions are for information only and may be subject to modifications. Contractual 2D drawings can be downloaded from the Leroy-Somer site, 3D drawing files are available upon request. The torsional analysis of the transmission is imperative. All values are available upon request.

Two-bearing dimensions

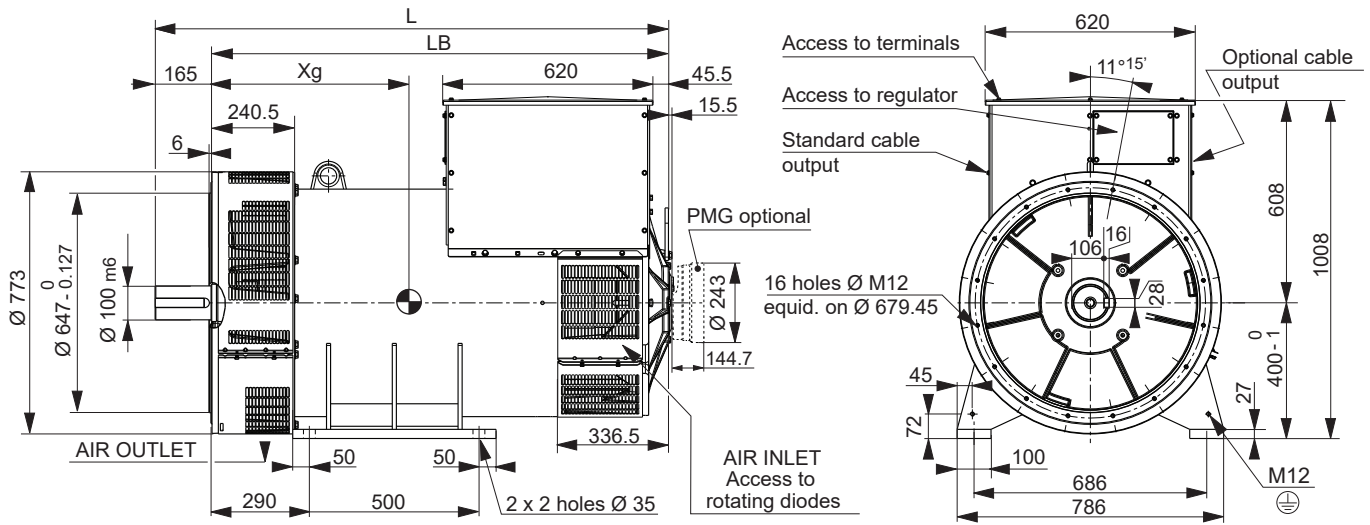

| Dimensions (mm) and weight |               |      |     |             |
|----------------------------|---------------|------|-----|-------------|
| Type                       | L without PMG | LB   | Xg  | Weight (kg) |
| LSA 49.3 S4                | 1424          | 1259 | 596 | 1480        |
| LSA 49.3 M6                | 1514          | 1349 | 636 | 1622        |
| LSA 49.3 M8                | 1514          | 1349 | 643 | 1683        |
| LSA 49.3 L9                | 1604          | 1439 | 682 | 1835        |
| LSA 49.3 L10               | 1604          | 1439 | 688 | 1884        |

Torsional analysis data

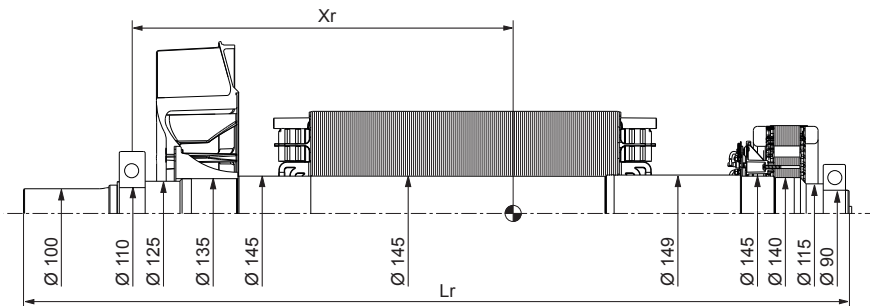

| Centre of gravity: Xr (mm), Rotor length: Lr (mm), Weight: M (kg), Moment of inertia: J (kgm²): (4J = MD²) |     |      |     |       |
|--|-----|------|-----|-------|
| Type   | Xr  | Lr   | M   | J     |
| LSA 49.3 S4  | 545 | 1409 | 512 | 8.07  |
| LSA 49.3 M6  | 584 | 1499 | 574 | 9.18  |
| LSA 49.3 M8  | 590 | 1499 | 600 | 9.73  |
| LSA 49.3 L9  | 627 | 1589 | 656 | 10.69 |
| LSA 49.3 L10   | 634 | 1589 | 673 | 11.05 |

**NOTE :** Dimensions are for information only and may be subject to modifications. Contractual 2D drawings can be downloaded from the Leroy-Somer site, 3D drawing files are available upon request. The torsional analysis of the transmission is imperative. All values are available upon request.

**LEROY-SOMER**<sup>™</sup>

[www.leroy-somer.com/epg](http://www.leroy-somer.com/epg)

Connect with us at:



***Nidec***  
All for dreams

© 2022 Moteurs Leroy-Somer SAS. The information contained in this brochure is for guidance only and does not form part of any contract. The accuracy cannot be guaranteed as Moteurs Leroy-Somer SAS have an ongoing process of development and reserve the right to change the specification of their products without notice.

Moteurs Leroy-Somer SAS. Headquarters: Bd Marcellin Leroy, CS 10015, 16915 Angoulême Cedex 9, France. Share Capital: 38,679,664 €, RCS Angoulême 338 567 258.