



# RENTAL SOLUTIONS





**WHENEVER YOU NEED POWER,  
WE ARE ALWAYS WITH YOU...  
SINCE 1994!**

---



Since 1994, Teksan has been delivering high quality tailormade solutions that are designed accordingly to your requirements with strong after-sales technical support and maintenance services anytime and anywhere you need uninterrupted power supply. When your company is moving further ahead rapidly on the road to success, you always feel our continuous support as your reliable power solutions partner.

*Because Teksan is a member of your family...*

WE DELIVER POWER TO THE WORLD



 **2** factories  
60.000 sqm+  
TOTAL PRODUCTION AREA

 **800+**  
employees

 **15.000**  
gensets  
ANNUAL PRODUCTION CAPACITY

## THE STRUCTURE OF A POWERFUL FUTURE

---

With our vision of being a global brand that makes a difference in the energy sector and our mission of being a reliable and innovative solution partner for a sustainable life, we keep producing power solutions for different sectors in more than 140 countries of the world and shape the future with our corporate values that at all times carry us forward!



# HIGH PERFORMANCE TEKSAN RENTAL DIESEL GENSETS

- Gensets in different sizes from 36kVA up to 702kVA PRP at 60Hz, 3Ph
- Engine mounted radiator with vertical air discharge
- Starter motor and charge alternator
- Fuel tank equipped with 3 way valve for external fuel tank
- Set mounted digital controller, with convenience panel
- Heavy duty steel base frame with integral fuel tank, forklift pockets
- Enhanced product safety for generating sets and users (safe connection points, circuit breakers, forklift points, etc...)
- Easy and safe access for service operations
- Improved performance against extreme environmental conditions
- ISO 8528-5 standard, provides a high starting and loading capacity for critical applications best in noise levels. Thanks to the robust enclosure (sound proof canopy or container)
- Convenient quick connect powerlocks and busbar connection
- Long service and maintenance intervals with maximum engine running time



## QUICK-COUPLING FUEL CONNECTION



## CONVENIENCE PANEL



## UP TO 24 HOURS FUEL TANK

Our specific designed fuel tank provides with up to 24+ hours running time along as well as easy access and hassle free fuel filling.



## 3-WAY VALVE



## BATTERY ISOLATOR SWITCH



## VOLTAGE SELECTOR SWITCH

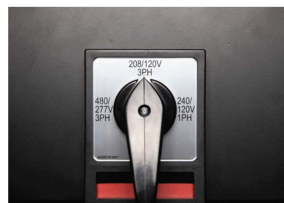



## USABILITY

- Dedicated accesses
- Quick connect powerlocks and busbar
- Radiator access door



## DURABILITY

- Large and strong banded frame (retention fuel tank capacity for 110% of generator liquids, up to 24+ hours autonomy fuel tank)
- Strong and compact design
- Double impregnation alternator
- Waterproof wiring and connectors



## SAFETY

- Door retainers
- Large engine access doors with anti-opening lock system to avoid opening during transport
- Water and dust proof control power box integrating electronic and electric devices



## HANDLING

- Integrated single top lifting point
- Lifting points on the base frame















## MAINTENANCE

- Enclosure doors with increased insulation thickness and high acoustic performance who designed to facilitate the access to engine and alternator
- Fuel pre filter
- Manual oil drain pump
- Door access for an easy cleaning of the radiator
- External fuel filling (quick couplink)
- Three way fuel valve



- |                                     |                                    |
|-------------------------------------|------------------------------------|
| 1 CONVENIENCE PANEL                 | 7 EXHAUST OUTLET                   |
| 2 TOW EYE                           | 8 ACOUSTIC ENCLOSURE DOORS         |
| 3 CONTROL PANEL                     | 9 EXTERNAL FUEL QUICK CONNECTORS   |
| 4 SOUND AND WEATHER PROOF ENCLOSURE | 10 TRAILER MOUNTING HOLES          |
| 5 RADIATOR FILLING                  | 11 FORKLIFT POCKETS                |
| 6 HOT AIR OUTLET                    | 12 AEROACUSTIC AIR IN TAKE POCKETS |

## 60Hz RENTAL TIER 4F

60 Hz GENSET MODEL	480/277V AC		208/120V-3PH		240/120V-1PH		MANUFACTURER	ENGINE MODEL	GENERATOR MODEL	EMISSION CLASS	AFTERTREATMENT UNITS	DIMENSIONS (inches)			Total Weight of Genset (lbs)	Fuel Tank Capacity (gal)	Fuel Tank Capacity (h)	Fuel Consumption (gal/h) 100%	DEF Tank Capacity (gal)	DEF Tank Capacity (hour) (100%)
	STAND-BY kVA	PRIME kVA	STAND-BY kVA	PRIME kVA	STAND-BY kVA	PRIME kVA						WIDTH	LENGTH	HEIGHT						
TJT4F36DW	41	36	40	36	28	28		D18	LSA 42.3 S5	TIER 4F	DOC	44,5	110,2	66,5	2862	71	27	2,6	N/A	N/A
TJT4F49DW	54	49	54	49	39	37		D24	LSA42.3L9	TIER 4F	DOC	44,5	110,2	66,5	2981	71	22	3,2	N/A	N/A
TJT4F92DW	102	92	102	92	76	73		D34	LSA44.3M6	TIER 4F	DOC+SCR	44,5	122,0	80,7	4626	159	29	5,4	7,93	14,6
TJT4F66JD	73	66	73	66	52	52		4045HFG04_68	LSA 44.3 S3	TIER 4F	DOC+SCR	44,5	122,0	80,7	4373	159	46	3,4	5,63	41,0
TJT4F78JD	86	78	86	78	65	62		4045HFG04_80	LSA 44.3 S5	TIER 4F	DOC+SCR	44,5	122,0	80,7	4454	159	39	4,0	5,63	32,4
TJT4F97JD	107	97	107	97	81	77		4045HFG04_99	LSA 44.3 M8	TIER 4F	DOC+SCR	44,5	122,0	80,7	4600	159	32	5,0	7,95	37,0
TJT4F128JD	141	128	141	128	95	95		4045HFG06_128	LSA44.3L10	TIER 4F	DOC+SCR	47,2	133,9	88,6	4837	185	28	6,6	7,95	30,3
TJT4F196JD	216	196	216	196	164	149		6068HFG05_192	LSA46.3S5	TIER4F	DOC+SCR	55,1	155,5	93,5	6216	277	27	10,4	7,95	23,8
TJT4F248JD	272	248	272	248	200	189		6068HFG06_240	LSA 46.3 M8*	TIER4F	DOC+SCR	65,0	189,0	96,5	8023	415	35	11,9	14,85	37,8
TJT4F325JD	358	325	358	325	231	231		6090HFG06_326	LSA 46.3 L11	TIER4F	DOC+SCR	65,0	189,0	96,5	9116	415	26	15,9	14,85	33,5
TJT4F510JD	560	510	560	510	TBA	TBA		6136CG440_505	LSA 47.3 M7	TIER 4F	DOC+SCR	78,7	213,8	100,4	11014	608	25	24,6	14,85	12,9
TJT4F625V	690	625	690	625	TBA	TBA		TWD1672GE	LSA47.3L10	TIER4F	SCR	78,7	213,8	100,4	13285	608	18	34,3	42,27	17,4
TJT4F700V	770	700	770	700	TBA	TBA		TWD1673GE	LSA49.3M6	TIER4F	SCR	78,7	213,8	100,4	13647	608	16	38,3	42,27	17,2

\* Stand-by

# ALWAYS AT YOUR SERVICE...

- Management of the service records on servers for proactive after sales services,
- Remote Monitoring and Management System,
- Call Center support.



## UNIQUE AFTER SALES SERVICES AND TECHNICAL SUPPORT SOLUTIONS FOR YOUR PROJECTS;

- Free of charge site and power identification with our business partners or Teksan After Sales Services.
- Technical support and consultancy,
- Assembly and disassembly,
- Installation, commissioning,
- General maintenance services,
- Emergency calls,
- Modification, repair, revision\*,
- Periodical maintenance services.



Thanks to our experienced engineering teams and technological infrastructure, we can meet your revision demands for all engine types and brands.

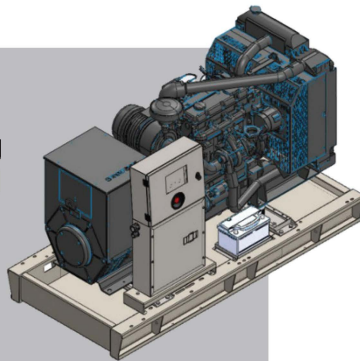

# WE ARE YOUR EVERLASTING COMPANY

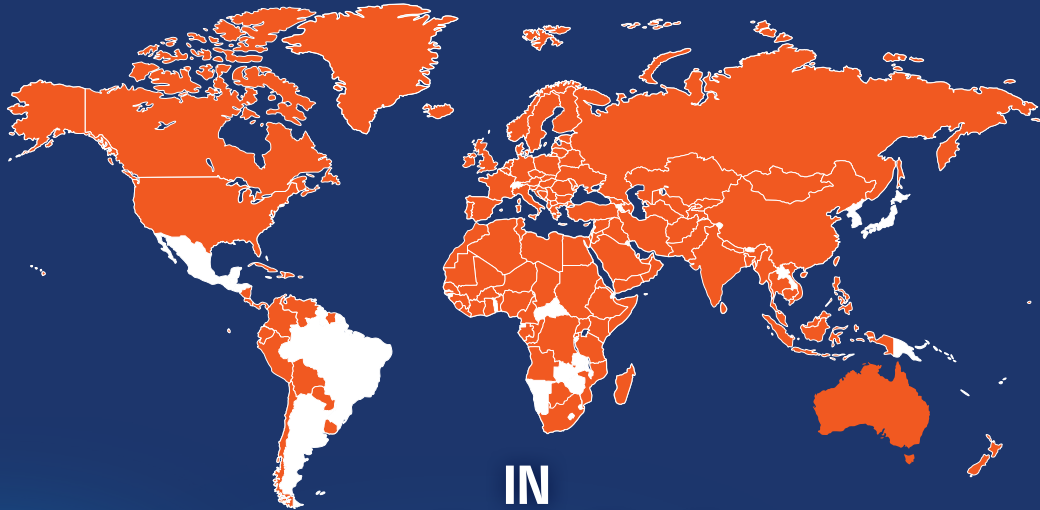

IN  
**140+**  
COUNTRIES



USA BRANCH OFFICE



+1 224 **404 1274**  
[www.teksanus.com](http://www.teksanus.com)  
[info@teksanus.com](mailto:info@teksanus.com)

TURKEY HEADQUARTER



+90 **444 8576**  
[www.teksan.com](http://www.teksan.com)  
[info@teksan.com](mailto:info@teksan.com)

The logo for TEKSAN USA, featuring a stylized 'T' icon followed by the text 'TEKSAN USA' in a bold, sans-serif font.