

ALTERNATOR DATASHEET

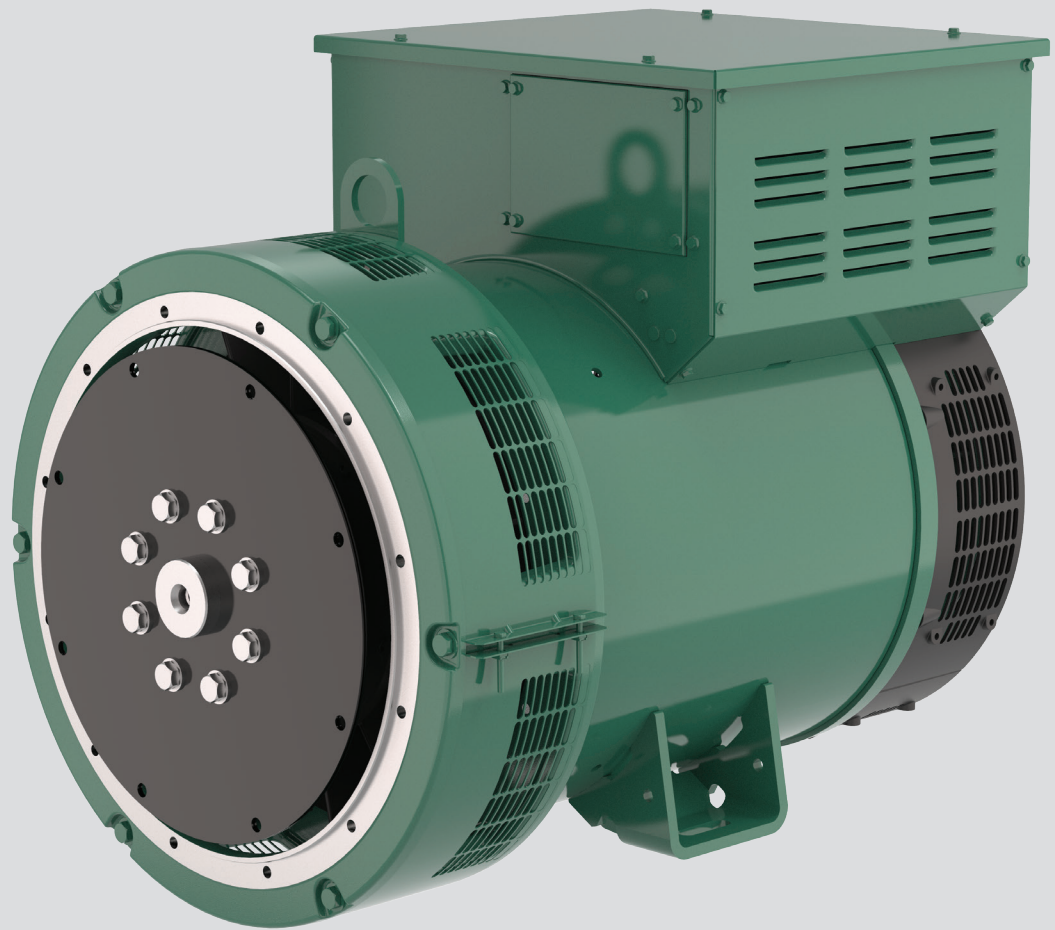



LSA 46.3

Low Voltage Alternator - 4 pole

230 to 365 kVA - 50 Hz / 288 to 456 kVA - 60 Hz
Electrical and mechanical data

LEROY-SOMER[™]

Nidec
All for dreams

The best of performance

Nidec Leroy-Somer LSA 46.3 alternator has been designed to offer you the best power generation performances. With its meticulous design and optimized architecture, the LSA 46.3 strikes the perfect balance between compactness, reliability, performance and longevity.

Whatever your application, the LSA 46.3 will meet your needs and will adapt to all situations.

Standards

Nidec Leroy-Somer LSA 46.3 alternator meets all key international standards and regulations, including IEC 60034, NEMA MG 1.32-33, ISO 8528-3, CSA C22.2 n°100-14 and UL 1446 (UL 1004 on request). Also compliant with IEC 61000-6-2, IEC 61000-6-3, IEC 61000-6-4, VDE 0875G, VDE 0875N and EN 55011, group 1 class A for European zone.

Nidec Leroy-Somer LSA 46.3 alternator can be integrated in EC marked generator set, and bears EC and CMIM markings. It is designed, manufactured and marketed in an ISO 9001 and ISO 14001 quality assurance environment.

Electrical characteristics and performances

- Class H insulation
- 2/3 pitch winding, standard 12-wire (6) reconnectable
- Voltage range:
 - 50 Hz: 220V - 240V and 380V - 415V (440V)
 - 60 Hz: 208V - 240V and 380V - 480V
- High efficiency and motor starting capacity
- Other voltages are possible with optional adapted windings:
 - 50 Hz: 440V (no. 7), 500V (no. 9), 550V (no. 22), 600V (no. 23), 690V (no. 10 or 52)
 - 60 Hz: 380V and 416V (no. 8), 600V (no. 9), 690V (no. 22)

Excitation and regulation system

| Excitation system | | | | Regulation options | | |
|-------------------|----------|---------------|--------------|--|-------------------|------------------------------|
| AVR | SHUNT | AREP (option) | PMG (option) | C.T. Current transformer for paralleling | Mains paralleling | Remote voltage potentiometer |
| R250 | Standard | | | | | √ |
| D350 | Option | Standard | Standard | √* | | √ |
| D550 | Option | Option | Option | √* | √ | √ |

*: only with AREP or PMG

3-phase sensing is included as a standard with digital regulators.

Protection system and options

- The LSA 46.3 is IP 23
- Complete winding protection for clean environments with relative humidity ≤ 95 %, including indoor marine environments
- Options:
 - Filters on air inlet: derating 5%
 - Filters on air inlet and air outlet (IP 44): derating 10%
 - Reinforced winding protection for harsh environments and relative humidity greater than 95%
 - Space heater
 - Thermal protection for stator windings and shields

Mechanical construction

- Compact and rigid assembly to better withstand generator vibrations
- Steel frame
- Cast iron flanges and shields
- Two-bearing and single-bearing versions designed to be suitable for engines on the market
- Half-key balancing
- Greased for life bearings, regreasable bearings (optional)
- Direction of rotation: clockwise and anti-clockwise (without derating)

Terminal box design

- Easy access to the voltage regulator and to the connections
- Possible inclusion of accessories for paralleling, protection and measurement
- 9-way terminal block for voltage reconnection

LSA 46.3 - 230 to 365 kVA - 50 Hz / 288 to 456 kVA - 60 Hz

General characteristics

| | | | | |
|------------------|---------------------------------------|------------------------------------|---------------------------------|-------------------|
| Insulation class | H | Excitation system | SHUNT | AREP / PMG |
| Winding pitch | 2/3 (wind. 6) | AVR type | R250 | D350 |
| Number of wires | 12 | Voltage regulation (*) | ± 0.5% | ± 0.25% |
| Protection | IP 23 | Short-circuit current | - | 300% (3 IN) : 10s |
| Altitude | ≤ 1000 m | Total Harmonic Distortion THD (**) | no load < 2.5% - on load < 2.5% | |
| Overspeed | 2250 R.P.M. | Waveform: NEMA = TIF (**) | < 50 | |
| Air flow | 0.48 m³/s (50 Hz) / 0.58 m³/s (60 Hz) | Waveform: I.E.C. = THF (**) | < 2% | |

(*) Steady state (**) Total harmonic distortion between phases, no-load or on-load (non-distorting)

Ratings 50 Hz - 1500 R.P.M.

| kVA / kW - P.F. = 0.8 | | | | | | | | | | | | | | | | | | | | |
|-------------------------|----------------------|-------------|------|-------------|------|----------------------|-------------|------|-------------|------|---------------|-------------|-------|---------------|------|------|-------------|------|-------------|------|
| Duty/T°C | Continuous duty/40°C | | | | | Continuous duty/40°C | | | | | Stand-by/40°C | | | Stand-by/27°C | | | | | | |
| Class/T°C | H/125°K | | | | | F/105°K | | | | | H/150°K | | | H/163°K | | | | | | |
| Phase | 3 ph. | | | 1 ph. | | 3 ph. | | | 1 ph. | | 3 ph. | | 1 ph. | 3 ph. | | | 1 ph. | | | |
| Y | 380V | 400V | 415V | 440V | ΔΔ | 380V | 400V | 415V | 440V | ΔΔ | 380V | 400V | 415V | 440V | ΔΔ | 380V | 400V | 415V | 440V | ΔΔ |
| Δ | 220V | 230V | 240V | | 230V | 220V | 230V | 240V | | 230V | 220V | 230V | 240V | | 230V | 220V | 230V | 240V | | 230V |
| YY | | 200V | | 220V | | | 200V | | 220V | | | 200V | | 220V | | | 200V | | 220V | |
| LSA 46.3 S4 kVA | 230 | 230 | 230 | 219 | 138 | 209 | 209 | 209 | 200 | 126 | 244 | 244 | 244 | 232 | 146 | 253 | 253 | 253 | 240 | 152 |
| kW | 184 | 184 | 184 | 175 | 110 | 167 | 167 | 167 | 160 | 101 | 195 | 195 | 195 | 186 | 117 | 202 | 202 | 202 | 192 | 122 |
| LSA 46.3 S5 kVA | 240 | 250 | 250 | 238 | 150 | 218 | 228 | 228 | 216 | 137 | 254 | 265 | 265 | 252 | 159 | 264 | 275 | 275 | 261 | 165 |
| kW | 192 | 200 | 200 | 190 | 120 | 174 | 182 | 182 | 173 | 110 | 204 | 212 | 212 | 202 | 127 | 211 | 220 | 220 | 209 | 132 |
| LSA 46.3 M7 kVA | 275 | 275 | 275 | 261 | 165 | 250 | 250 | 250 | 238 | 150 | 292 | 292 | 292 | 277 | 175 | 303 | 303 | 303 | 287 | 182 |
| kW | 220 | 220 | 220 | 209 | 132 | 200 | 200 | 200 | 190 | 120 | 234 | 234 | 234 | 222 | 140 | 242 | 242 | 242 | 230 | 146 |
| LSA 46.3 M8 kVA | 290 | 300 | 300 | 285 | 180 | 264 | 273 | 273 | 259 | 164 | 307 | 318 | 318 | 302 | 191 | 319 | 330 | 330 | 313 | 200 |
| kW | 232 | 240 | 240 | 228 | 144 | 211 | 218 | 218 | 207 | 131 | 246 | 254 | 254 | 242 | 153 | 255 | 264 | 264 | 250 | 160 |
| LSA 46.3 L10 kVA | 325 | 325 | 325 | 309 | 195 | 300 | 300 | 300 | 281 | 177 | 345 | 345 | 345 | 327 | 207 | 358 | 358 | 358 | 340 | 215 |
| kW | 260 | 260 | 260 | 247 | 156 | 240 | 240 | 240 | 225 | 142 | 276 | 276 | 276 | 262 | 166 | 286 | 286 | 286 | 272 | 172 |
| LSA 46.3 L11 kVA | 350 | 365 | 365 | 347 | 210 | 319 | 332 | 332 | 316 | 191 | 371 | 387 | 387 | 368 | 225 | 385 | 400 | 400 | 380 | 231 |
| kW | 280 | 292 | 292 | 277 | 168 | 255 | 266 | 266 | 253 | 153 | 297 | 310 | 310 | 294 | 180 | 308 | 320 | 320 | 304 | 185 |

Ratings 60 Hz - 1800 R.P.M.

| kVA / kW - P.F. = 0.8 | | | | | | | | | | | | | | | | | | | | |
|-------------------------|----------------------|-------------|------------|-------------|------------|----------------------|-------------|------|-------------|-----|---------------|-------------|-------|---------------|-----|------|-------------|------|-------------|-----|
| Duty/T°C | Continuous duty/40°C | | | | | Continuous duty/40°C | | | | | Stand-by/40°C | | | Stand-by/27°C | | | | | | |
| Class/T°C | H/125°K | | | | | F/105°K | | | | | H/150°K | | | H/163°K | | | | | | |
| Phase | 3 ph. | | | 1 ph. | | 3 ph. | | | 1 ph. | | 3 ph. | | 1 ph. | 3 ph. | | | 1 ph. | | | |
| Y | 380V | 416V | 440V | 480V | ΔΔ | 380V | 416V | 440V | 480V | ΔΔ | 380V | 416V | 440V | 480V | ΔΔ | 380V | 416V | 440V | 480V | ΔΔ |
| Δ | 220V | 240V | | 240V | | 220V | 240V | | 240V | | 220V | 240V | | 240V | | 220V | 240V | | 240V | |
| YY | | 208V | 220V | 240V | | | 208V | 220V | 240V | | | 208V | 220V | 240V | | | 208V | 220V | 240V | |
| LSA 46.3 S4 kVA | 226 | 250 | 262 | 288 | 152 | 206 | 227 | 238 | 262 | 138 | 240 | 264 | 278 | 305 | 161 | 250 | 274 | 288 | 316 | 167 |
| kW | 181 | 200 | 210 | 230 | 122 | 165 | 182 | 190 | 210 | 110 | 192 | 211 | 222 | 244 | 129 | 200 | 219 | 230 | 253 | 134 |
| LSA 46.3 S5 kVA | 245 | 265 | 280 | 313 | 165 | 223 | 241 | 255 | 284 | 150 | 260 | 281 | 297 | 331 | 175 | 270 | 292 | 308 | 344 | 182 |
| kW | 196 | 212 | 224 | 250 | 132 | 178 | 193 | 204 | 227 | 120 | 208 | 225 | 238 | 265 | 140 | 216 | 234 | 246 | 275 | 146 |
| LSA 46.3 M7 kVA | 275 | 300 | 315 | 344 | 182 | 250 | 273 | 287 | 313 | 165 | 292 | 318 | 334 | 364 | 192 | 303 | 330 | 347 | 378 | 200 |
| kW | 220 | 240 | 252 | 275 | 146 | 200 | 218 | 230 | 250 | 132 | 234 | 254 | 267 | 291 | 154 | 242 | 264 | 278 | 302 | 160 |
| LSA 46.3 M8 kVA | 290 | 315 | 340 | 375 | 200 | 264 | 287 | 309 | 337 | 180 | 307 | 334 | 360 | 395 | 210 | 319 | 347 | 375 | 412 | 218 |
| kW | 232 | 252 | 272 | 300 | 160 | 211 | 230 | 247 | 270 | 144 | 246 | 267 | 288 | 316 | 168 | 255 | 278 | 300 | 330 | 174 |
| LSA 46.3 L10 kVA | 315 | 345 | 365 | 406 | 215 | 287 | 314 | 332 | 370 | 195 | 334 | 366 | 387 | 431 | 227 | 347 | 380 | 402 | 447 | 236 |
| kW | 252 | 276 | 292 | 325 | 172 | 230 | 251 | 266 | 296 | 156 | 267 | 293 | 310 | 345 | 182 | 278 | 304 | 322 | 358 | 189 |
| LSA 46.3 L11 kVA | 360 | 393 | 419 | 456 | 231 | 328 | 358 | 381 | 415 | 210 | 382 | 417 | 444 | 483 | 250 | 396 | 432 | 461 | 502 | 254 |
| kW | 288 | 314 | 335 | 365 | 185 | 262 | 286 | 305 | 332 | 168 | 305 | 333 | 355 | 386 | 200 | 317 | 346 | 369 | 402 | 203 |

Efficiencies 400V - 50 Hz (— P.F.: 0.8) (--- P.F.: 1)

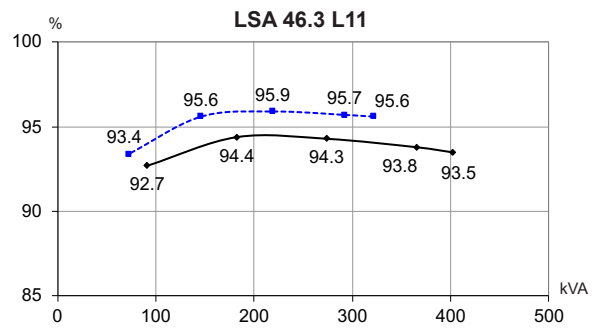
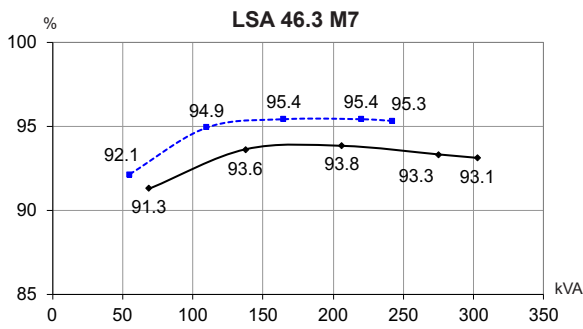
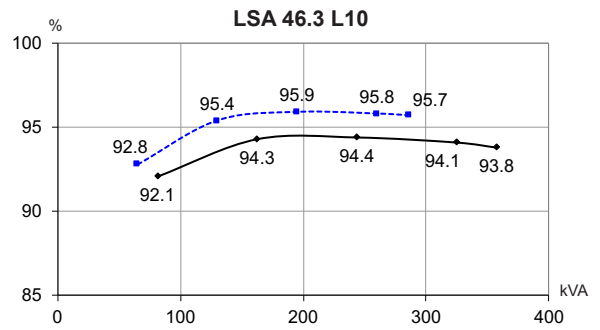
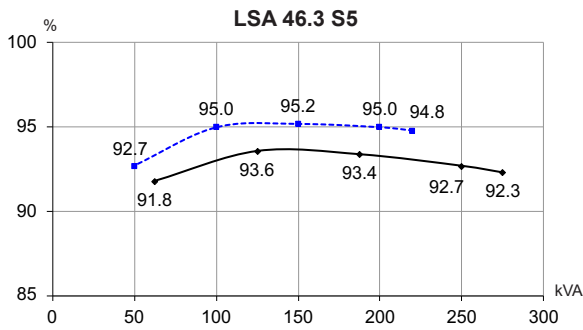
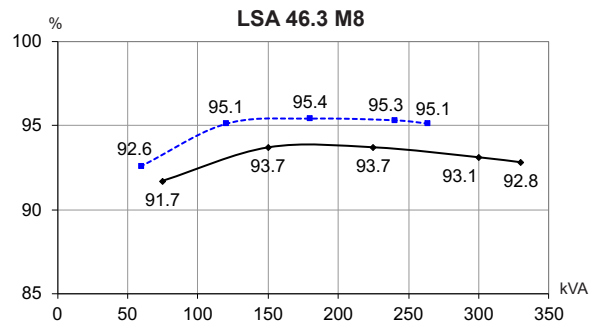
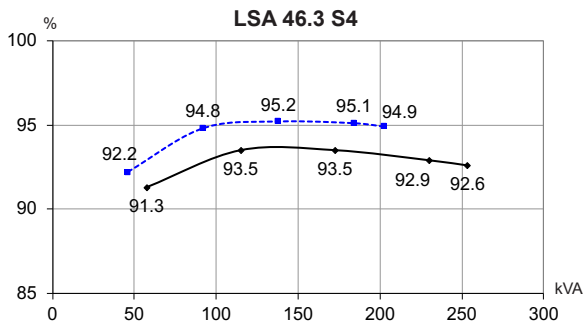

Reactances (%). Time constants (ms) - Class H / 400 V

| | S4 | S5 | M7 | M8 | L10 | L11 |
|--|-------|-------|-------|-------|-------|-------|
| Kcc Short-circuit ratio | 0.4 | 0.36 | 0.49 | 0.44 | 0.44 | 0.39 |
| Xd Direct-axis synchronous reactance unsaturated | 339 | 369 | 316 | 344 | 316 | 355 |
| Xq Quadrature-axis synchronous reactance unsaturated | 173 | 188 | 161 | 175 | 161 | 181 |
| T'do No-load transient time constant | 2452 | 2452 | 2543 | 2543 | 2686 | 2686 |
| X'd Direct-axis transient reactance saturated | 13.8 | 15 | 12.4 | 13.5 | 11.7 | 13.2 |
| T'd Short-circuit transient time constant | 100 | 100 | 100 | 100 | 100 | 100 |
| X''d Direct-axis subtransient reactance saturated | 11 | 12 | 9.9 | 10.8 | 9.4 | 10.5 |
| T''d Subtransient time constant | 10 | 10 | 10 | 10 | 10 | 10 |
| X''q Quadrature-axis subtransient reactance saturated | 14.6 | 15.9 | 13.1 | 14.3 | 12.6 | 14.1 |
| Xo Zero sequence reactance | 0.57 | 0.62 | 0.51 | 0.56 | 0.49 | 0.55 |
| X2 Negative sequence reactance saturated | 12.86 | 13.98 | 11.57 | 12.62 | 11.01 | 12.37 |
| Ta Armature time constant | 15 | 15 | 15 | 15 | 15 | 15 |

Other class H / 400 V data

| | | | | | | |
|--|-------|-------|-------|-------|-------|-------|
| io (A) No-load excitation current (SHUNT/AREP) | 0.78 | 0.78 | 0.94 | 0.94 | 0.81 | 0.81 |
| ic (A) On-load excitation current (SHUNT/AREP) | 3.06 | 3.32 | 3.14 | 3.41 | 2.94 | 3.29 |
| uc (V) On-load excitation voltage (SHUNT/AREP) | 41.4 | 44.6 | 46.2 | 49.7 | 42.8 | 47.5 |
| ms Response time ($\Delta U = 20\%$ transient) | 500 | 500 | 500 | 500 | 500 | 500 |
| kVA Start ($\Delta U = 20\%$ cont. or 30% trans.) SHUNT | 554 | 557 | 667 | 664 | 791 | 790 |
| kVA Start ($\Delta U = 20\%$ cont. or 30% trans.) AREP | 639 | 640 | 736 | 738 | 876 | 880 |
| % Transient ΔU (on-load 4/4) SHUNT - P.F.: 0.8 _{LAG} | 13.2 | 14 | 13.6 | 14.4 | 13.6 | 14.7 |
| % Transient ΔU (on-load 4/4) AREP - P.F.: 0.8 _{LAG} | 12.4 | 13.1 | 12.7 | 13.5 | 12.6 | 13.7 |
| W No-load losses | 3660 | 3660 | 4449 | 4449 | 4775 | 4775 |
| W Heat dissipation | 13869 | 15662 | 15583 | 17615 | 16271 | 19169 |

Transient voltage variation 400V - 50 Hz

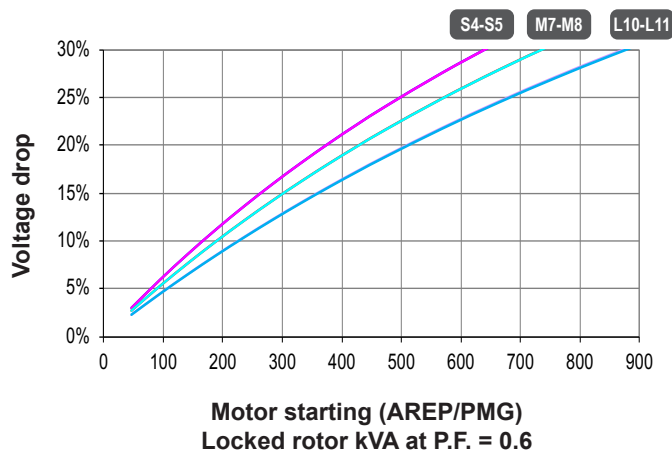
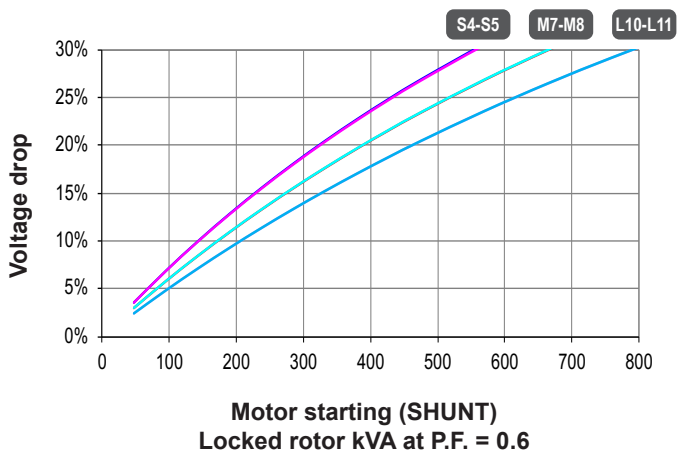
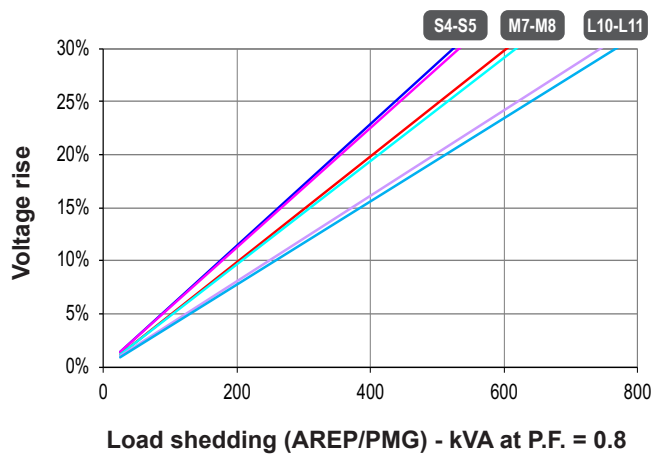
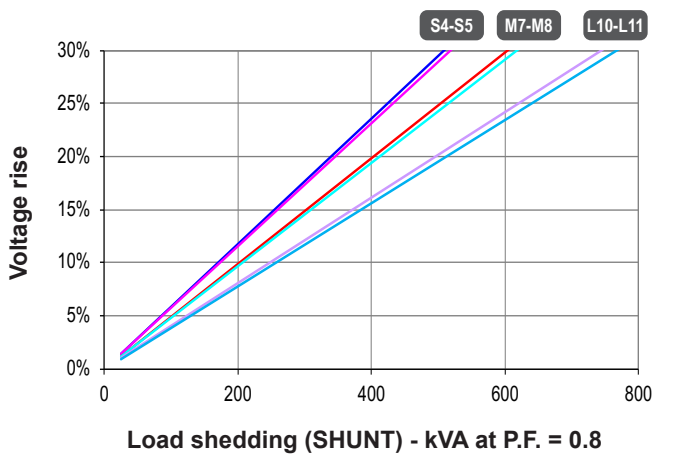
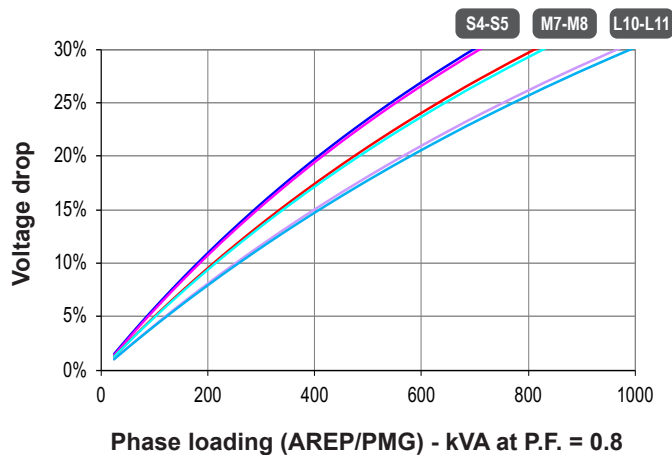
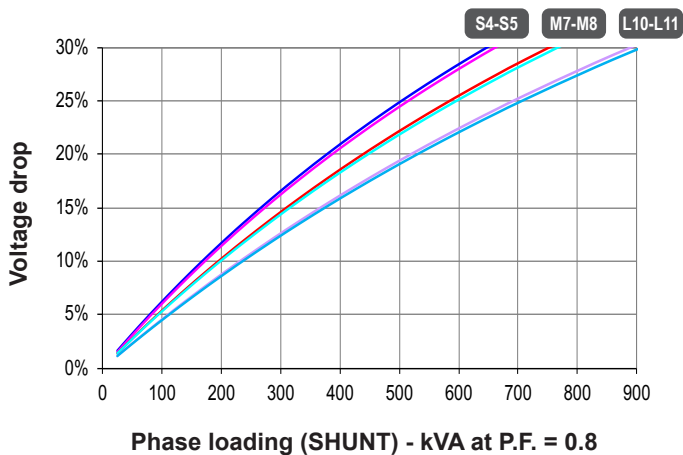

- 1) For a starting P.F. other than 0.6, the starting kVA must be multiplied by $K = \text{Sine P.F.} / 0.6$
- 2) For voltages other than 400V (Y), 230V (Δ) at 50 Hz, then kVA must be multiplied by $(400/U)^2$ or $(230/U)^2$.

Efficiencies 480V - 60 Hz (— P.F.: 0.8) (--- P.F.: 1)

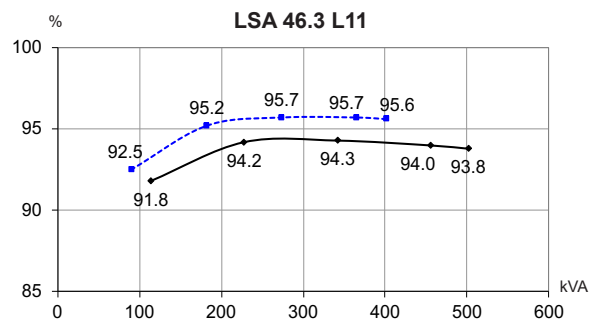
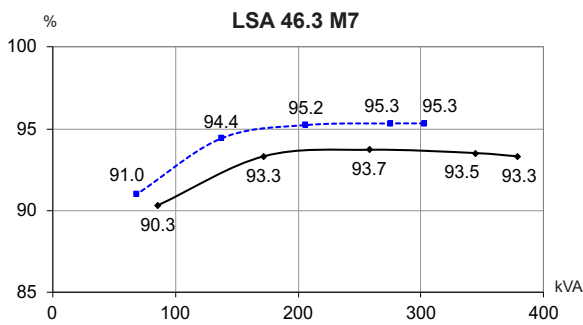
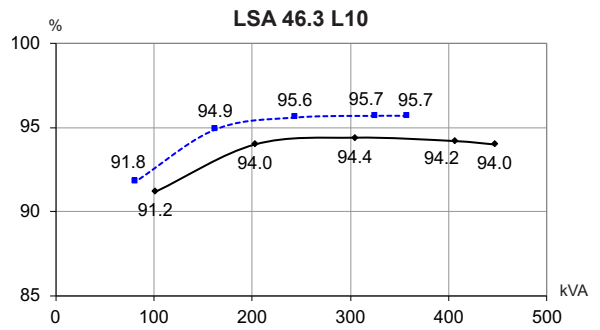
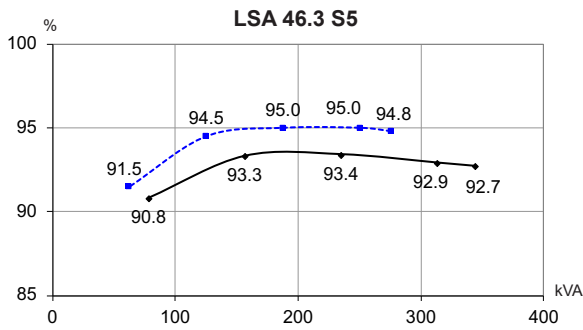
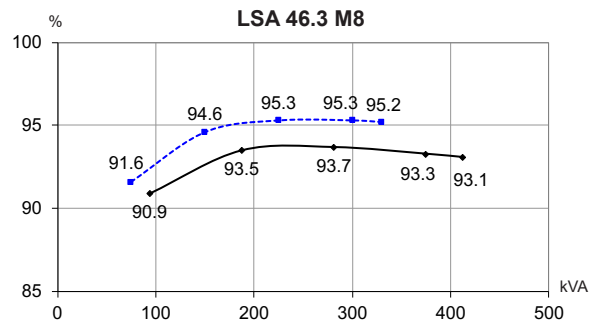
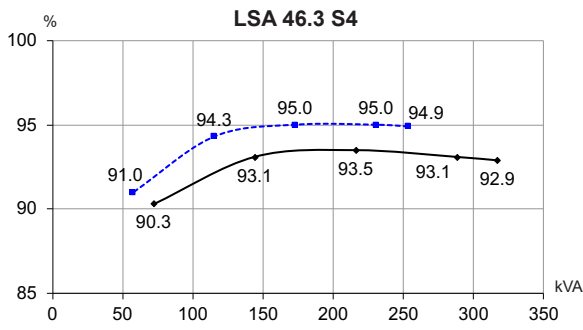

Reactances (%). Time constants (ms) - Class H / 480 V

| | S4 | S5 | M7 | M8 | L10 | L11 |
|--|-------|-------|-------|-------|-------|-------|
| Kcc Short-circuit ratio | 0.38 | 0.35 | 0.47 | 0.43 | 0.42 | 0.37 |
| Xd Direct-axis synchronous reactance unsaturated | 354 | 385 | 329 | 359 | 329 | 370 |
| Xq Quadrature-axis synchronous reactance unsaturated | 180 | 196 | 168 | 183 | 168 | 188 |
| T'do No-load transient time constant | 2452 | 2452 | 2543 | 2543 | 2686 | 2686 |
| X'd Direct-axis transient reactance saturated | 14.4 | 15.7 | 12.9 | 14.1 | 12.2 | 13.7 |
| T'd Short-circuit transient time constant | 100 | 100 | 100 | 100 | 100 | 100 |
| X''d Direct-axis subtransient reactance saturated | 11.5 | 12.5 | 10.3 | 11.2 | 9.8 | 11 |
| T''d Subtransient time constant | 10 | 10 | 10 | 10 | 10 | 10 |
| X''q Quadrature-axis subtransient reactance saturated | 15.2 | 16.6 | 13.7 | 14.9 | 13.1 | 14.1 |
| Xo Zero sequence reactance | 0.6 | 0.65 | 0.53 | 0.58 | 0.51 | 0.57 |
| X2 Negative sequence reactance saturated | 13.42 | 14.58 | 12.06 | 13.14 | 11.46 | 12.87 |
| Ta Armature time constant | 15 | 15 | 15 | 15 | 15 | 15 |

Other class H / 480 V data

| | | | | | | |
|---|-------|-------|-------|-------|-------|-------|
| io (A) No-load excitation current (SHUNT/AREP) | 0.78 | 0.78 | 0.94 | 0.94 | 0.81 | 0.81 |
| ic (A) On-load excitation current (SHUNT/AREP) | 3.05 | 3.3 | 3.13 | 3.38 | 2.92 | 3.26 |
| uc (V) On-load excitation voltage (SHUNT/AREP) | 41.7 | 44.9 | 46.5 | 50 | 43.1 | 47.7 |
| ms Response time ($\Delta U = 20\%$ transient) | 500 | 500 | 500 | 500 | 500 | 500 |
| kVA Start ($\Delta U = 20\%$ cont. or 30% trans.) SHUNT | 699 | 695 | 799 | 800 | 947 | 945 |
| kVA Start ($\Delta U = 20\%$ cont. or 30% trans.) AREP | 765 | 766 | 887 | 883 | 1055 | 1053 |
| % Transient ΔU (on-load 4/4) SHUNT - P.F.: 0.8_{LAG} | 13.6 | 14.4 | 14 | 14.9 | 13.9 | 15.1 |
| % Transient ΔU (on-load 4/4) AREP - P.F.: 0.8_{LAG} | 12.8 | 13.5 | 13.1 | 13.8 | 13 | 14 |
| W No-load losses | 5549 | 5549 | 6617 | 6617 | 7115 | 7115 |
| W Heat dissipation | 16897 | 18905 | 18951 | 21212 | 19891 | 23158 |

Transient voltage variation 480V - 60 Hz

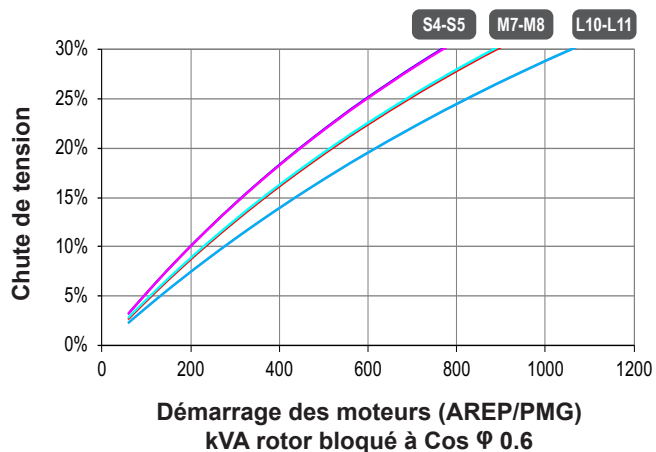
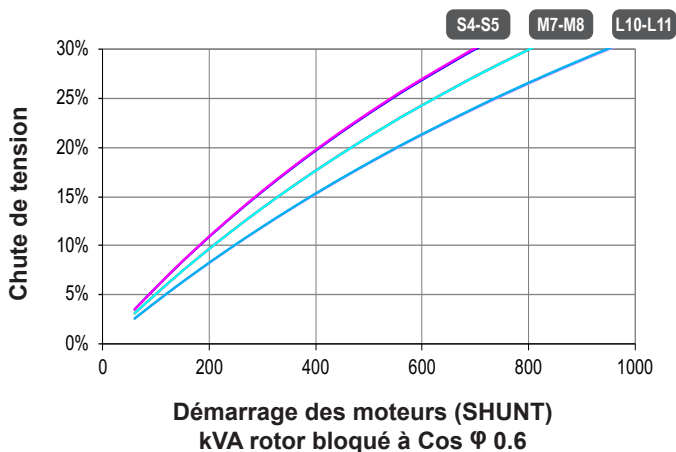
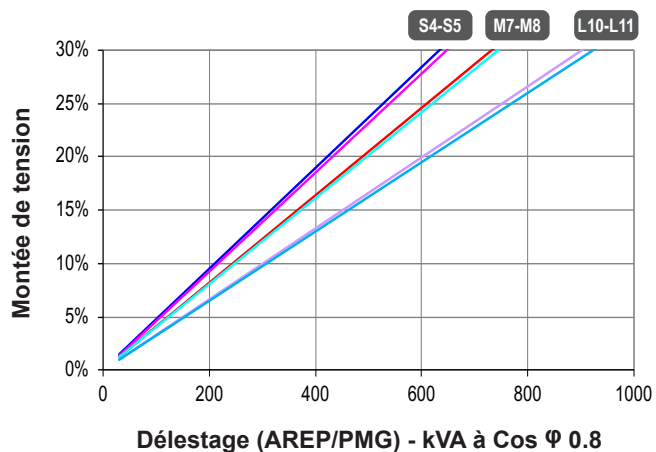
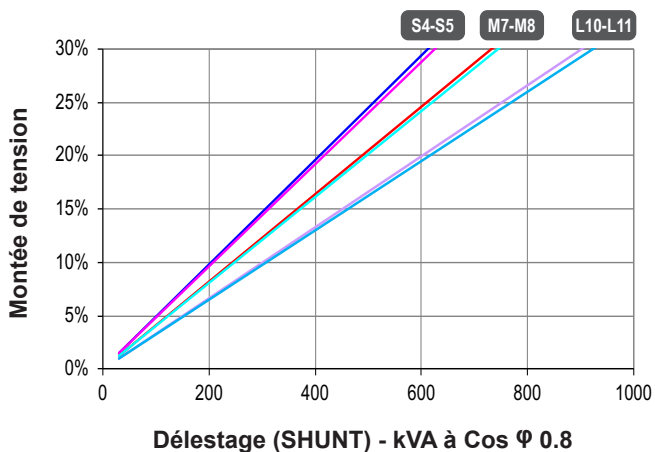
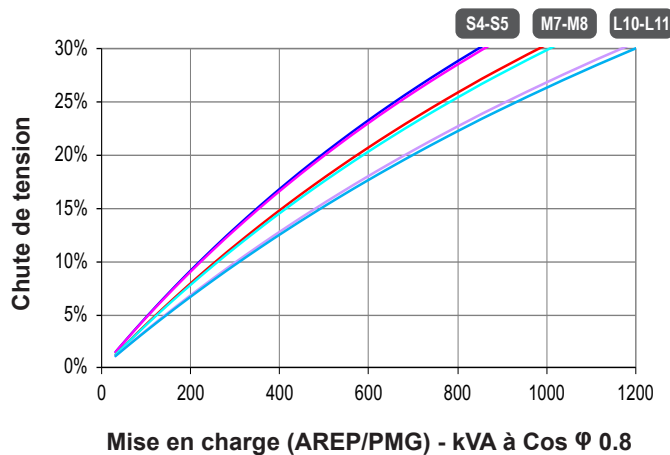
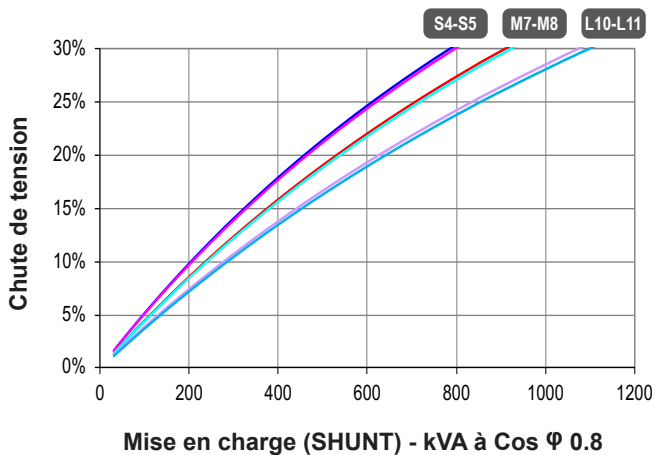

- 1) For a starting P.F. other than 0.6, the starting kVA must be multiplied by $K = \text{Sine P.F.} / 0.6$
- 2) For voltages other than 480V (Y), 277V (Δ), 240V (YY) at 60 Hz, then kVA must be multiplied by $(480/U)^2$ or $(277/U)^2$ or $(240/U)^2$.

3-phase short-circuit curves at no load and rated speed (star connection Y)

LSA 46.3 S4

Symmetrical —
Asymmetrical - - -

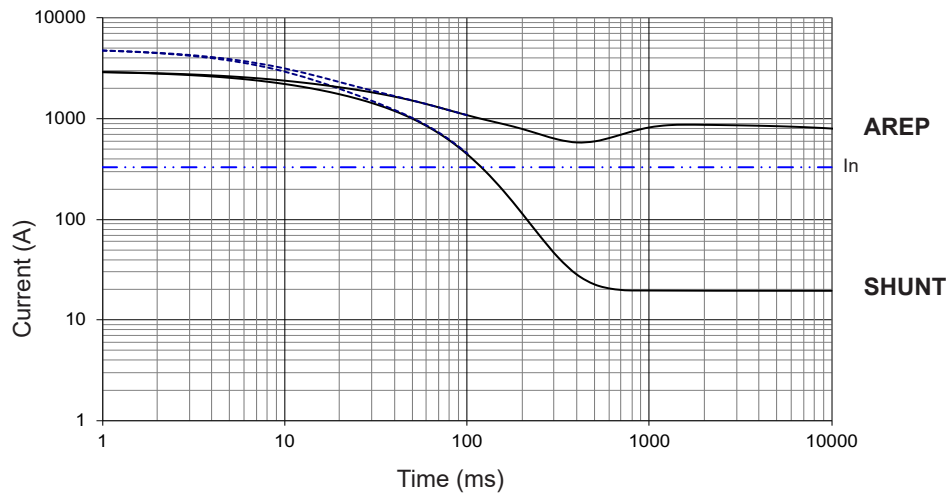

LSA 46.3 S5

Symmetrical —
Asymmetrical - - -

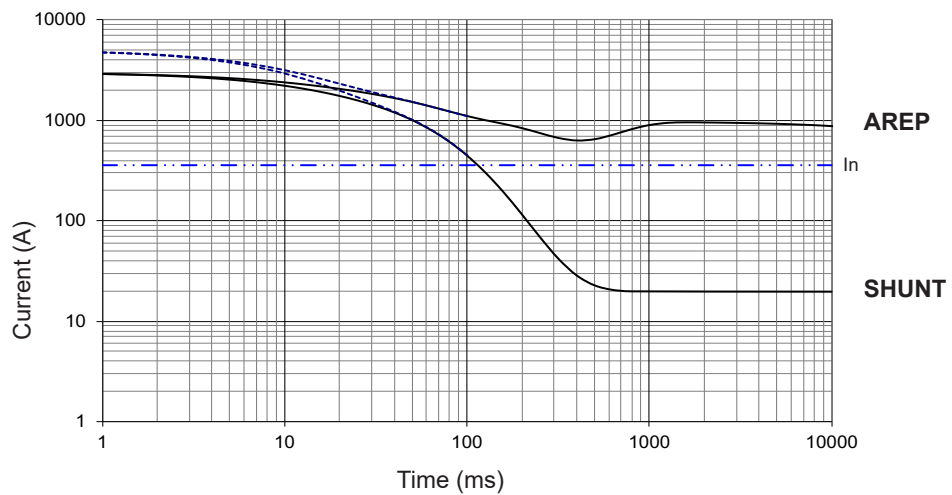

LSA 46.3 M7

Symmetrical —
Asymmetrical - - -

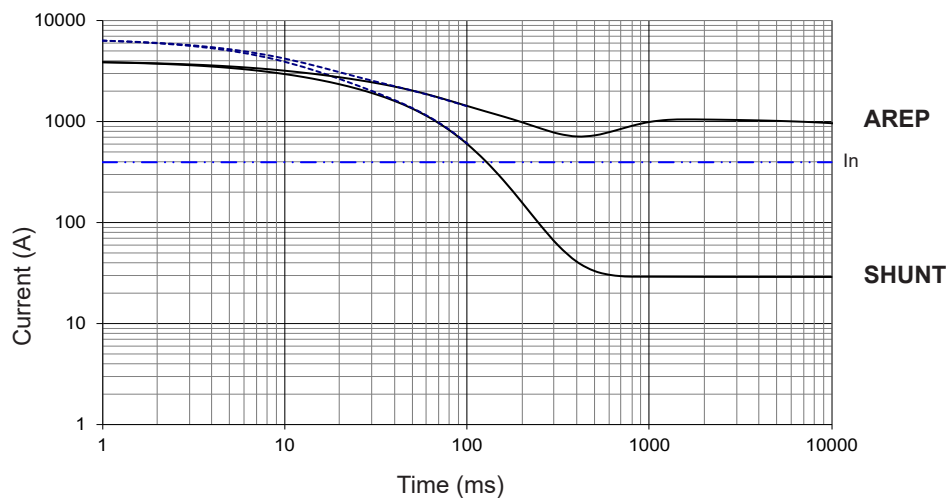

Influence due to connection

Curves shown are for star (Y) connection.

For other connections, use the following multiplication factors:

- Series delta : current value x 1.732 - Parallel star : current value x 2

3-phase short-circuit curves at no load and rated speed (star connection Y)

LSA 46.3 M8
 Symmetrical —
 Asymmetrical - - -

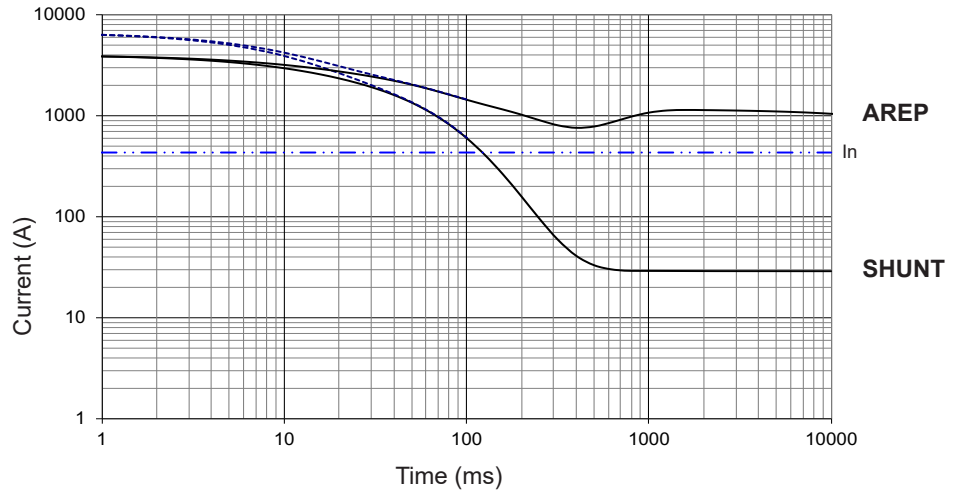

LSA 46.3 L10
 Symmetrical —
 Asymmetrical - - -

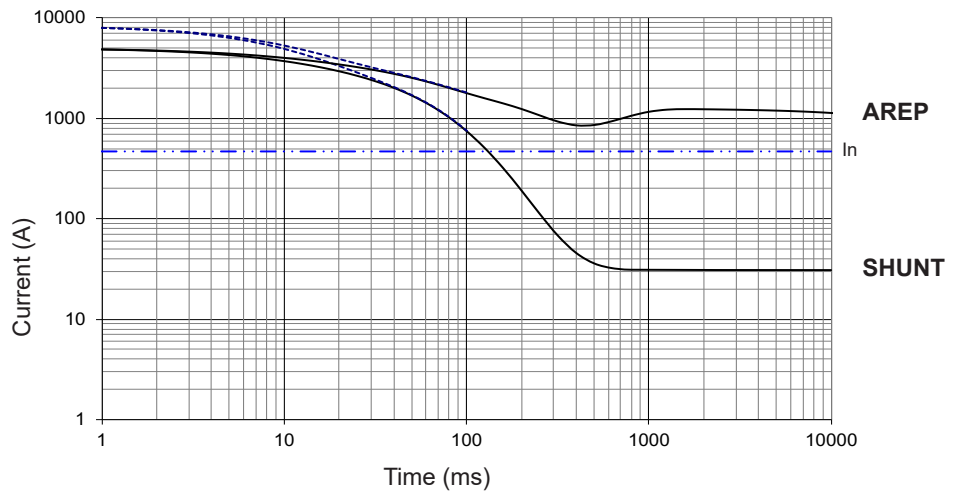

LSA 46.3 L11
 Symmetrical —
 Asymmetrical - - -

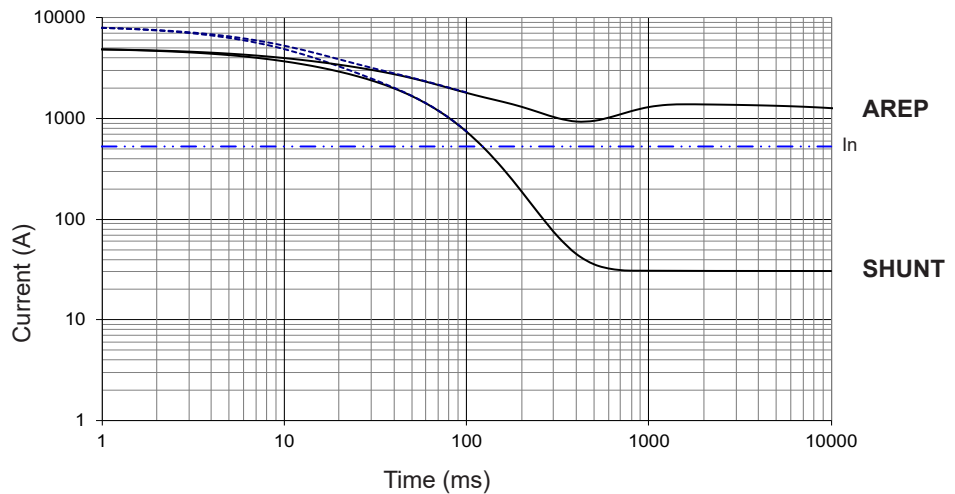

Influence due to short-circuit
 Curves are based on a three-phase short-circuit.
 For other types of short-circuit, use the following multiplication factors.

| | 3-phase | 2-phase L/L | 1-phase L/N |
|-----------------------------|---------|-------------|-------------|
| Instantaneous (max.) | 1 | 0.87 | 1.3 |
| Continuous | 1 | 1.5 | 2.2 |
| Maximum duration (AREP/PMG) | 10 sec. | 5 sec. | 2 sec. |

Single-bearing dimensions

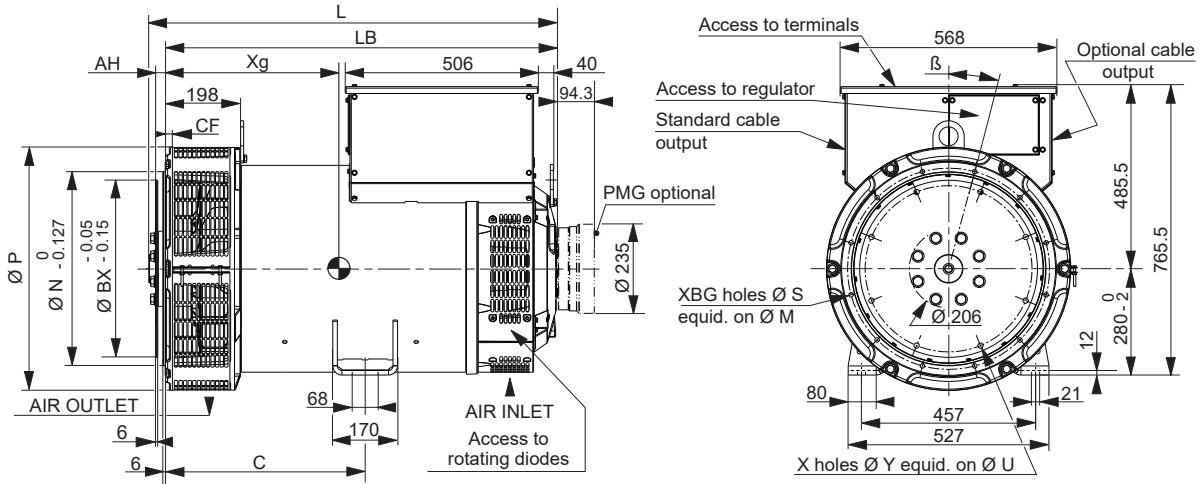

| Dimensions (mm) and weight | | | | | | Coupling | | | |
|----------------------------|---------------------|------|-----|-----|-------------|----------------|------|----|----|
| Type | L without PMG maxi* | LB | Xg | C | Weight (kg) | Flex plate | 11 ½ | 14 | 18 |
| LSA 46.3 S4 | 944 | 892 | 423 | 429 | 674 | Flange S.A.E 3 | X | | |
| LSA 46.3 S5 | 944 | 892 | 423 | 429 | 682 | Flange S.A.E 2 | X | | |
| LSA 46.3 M7 | 989 | 937 | 445 | 429 | 754 | Flange S.A.E 1 | X | X | |
| LSA 46.3 M8 | 989 | 937 | 445 | 429 | 754 | Flange S.A.E ½ | | X | |
| LSA 46.3 L10** | 1084 | 1032 | 493 | 525 | 888 | Flange S.A.E 0 | | X | X |
| LSA 46.3 L11** | 1084 | 1032 | 493 | 525 | 888 | | | X | X |

* L maxi = LB + AH maxi + 12.4 (only for SAE 11 ½) ** Shaft height = 355 mm optional

| Flange (mm) | | | | | | | | Flex plate (mm) | | | | | |
|-------------|----------|---------|---------|-----|----|---------|----|-----------------|--------|--------|---|----|------|
| S.A.E. | P | N | M | XBG | S | β° | CF | S.A.E. | BX | U | X | Y | AH |
| 3 | 600*/641 | 409.575 | 428.625 | 12 | 11 | 15° | 10 | 11 ½ | 352.42 | 333.38 | 8 | 11 | 39.6 |
| 2 | 600*/641 | 447.675 | 466.725 | 12 | 11 | 15° | 10 | 14 | 466.72 | 438.15 | 8 | 14 | 25.4 |
| 1 | 600*/641 | 511.175 | 530.225 | 12 | 12 | 15° | 10 | 18* | 571.5 | 542.92 | 6 | 17 | 15.7 |
| ½ | 713 | 584.2 | 619.125 | 12 | 14 | 15° | 6 | | | | | | |
| 0 | 713 | 647.7 | 679.45 | 16 | 14 | 11° 15' | 19 | | | | | | |

* Specific dimension LSA 46.3 S4

Torsional analysis data

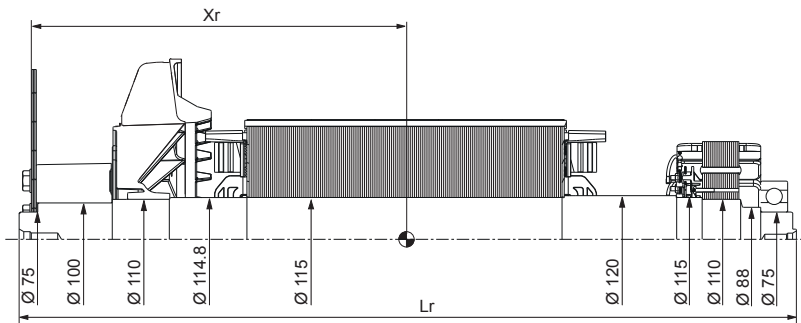

| Centre of gravity: Xr (mm), Rotor length: Lr (mm), Weight: M (kg), Moment of inertia: J (kgm²): (4J = MD²) | | | | | | | | | |
|--|-------------|-----|------|-----|-----------|-----|------|-----|------|
| Flex plate | S.A.E. 11 ½ | | | | S.A.E. 14 | | | | |
| | Type | Xr | Lr | M | J | Xr | Lr | M | J |
| LSA 46.3 S4 | | 431 | 928 | 277 | 2.93 | 416 | 928 | 277 | 3.09 |
| LSA 46.3 S5 | | 431 | 928 | 277 | 2.93 | 416 | 928 | 277 | 3.09 |
| LSA 46.3 M7 | | 459 | 973 | 307 | 3.23 | 444 | 973 | 307 | 3.39 |
| LSA 46.3 M8 | | 459 | 973 | 307 | 3.32 | 444 | 973 | 307 | 3.39 |
| LSA 46.3 L10 | | 507 | 1068 | 362 | 3.96 | 493 | 1068 | 362 | 4.12 |
| LSA 46.3 L11 | | 507 | 1068 | 362 | 3.96 | 493 | 1068 | 362 | 4.12 |

NOTE : Dimensions are for information only and may be subject to modifications. Contractual 2D drawings can be downloaded from the Leroy-Somer site, 3D drawing files are available upon request. The torsional analysis of the transmission is imperative. All values are available upon request.

Two-bearing dimensions

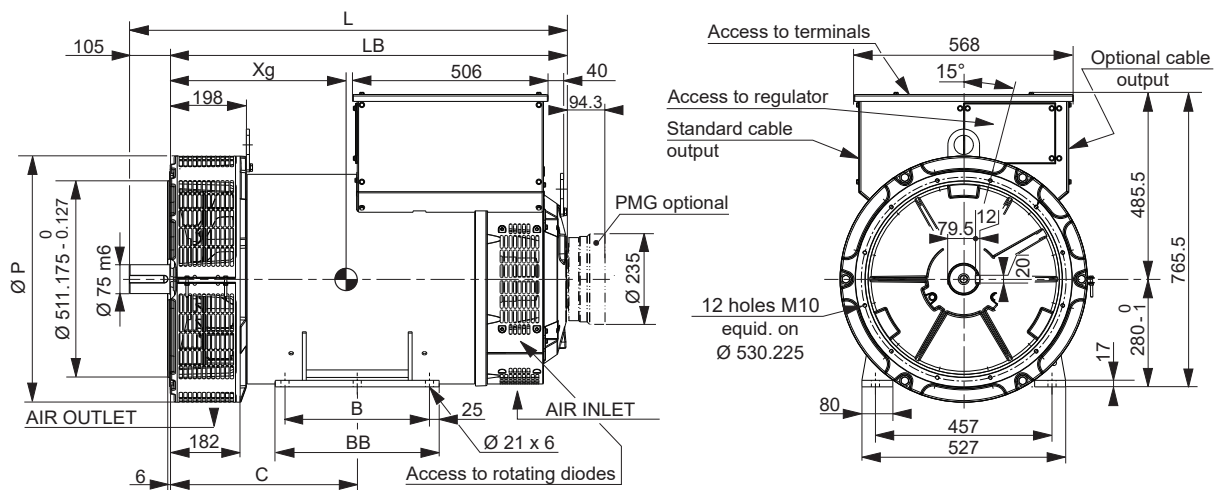

| Dimensions (mm) and weight | | | | | | | | |
|----------------------------|---------------|------|-----|-----|-----|-----|-----|-------------|
| Type | L without PMG | LB | C | BB | B | P | Xg | Weight (kg) |
| LSA 46.3 S4 | 997 | 892 | 389 | 368 | 318 | 600 | 427 | 674 |
| LSA 46.3 S5 | 997 | 892 | 389 | 368 | 318 | 640 | 427 | 682 |
| LSA 46.3 M7 | 1042 | 937 | 389 | 368 | 318 | 640 | 449 | 754 |
| LSA 46.3 M8 | 1042 | 937 | 389 | 368 | 318 | 640 | 449 | 754 |
| LSA 46.3 L10 | 1137 | 1032 | 485 | 424 | 374 | 640 | 496 | 888 |
| LSA 46.3 L11 | 1137 | 1032 | 485 | 424 | 374 | 640 | 496 | 888 |

Torsional analysis data

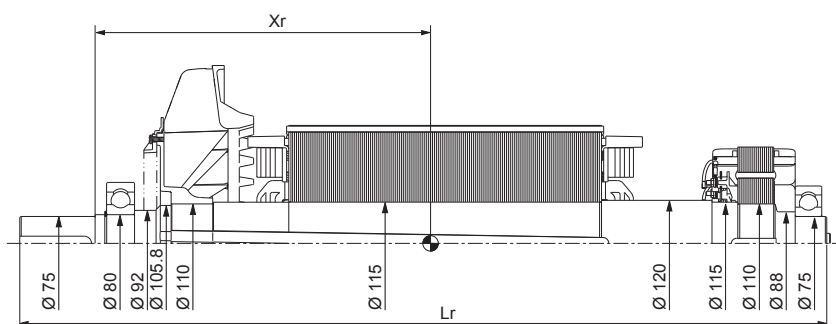

| Centre of gravity: X_r (mm), Rotor length: L_r (mm), Weight: M (kg), Moment of inertia: J (kgm^2): ($4J = MD^2$) | | | | |
|---|-------|-------|-----|------|
| Type | X_r | L_r | M | J |
| LSA 46.3 S4 | 430 | 990 | 250 | 2.76 |
| LSA 46.3 S5 | 430 | 990 | 250 | 2.76 |
| LSA 46.3 M7 | 456 | 1035 | 280 | 3.09 |
| LSA 46.3 M8 | 456 | 1035 | 280 | 3.09 |
| LSA 46.3 L10 | 503 | 1130 | 336 | 3.79 |
| LSA 46.3 L11 | 503 | 1130 | 336 | 3.79 |

NOTE : Dimensions are for information only and may be subject to modifications. Contractual 2D drawings can be downloaded from the Leroy-Somer site, 3D drawing files are available upon request.
The torsional analysis of the transmission is imperative. All values are available upon request.

LEROY-SOMER[™]

www.leroy-somer.com/epg

Connect with us at:



Nidec
All for dreams

© 2022 Moteurs Leroy-Somer SAS. The information contained in this brochure is for guidance only and does not form part of any contract. The accuracy cannot be guaranteed as Moteurs Leroy-Somer SAS have an ongoing process of development and reserve the right to change the specification of their products without notice.

Moteurs Leroy-Somer SAS. Headquarters: Bd Marcellin Leroy, CS 10015, 16915 Angoulême Cedex 9, France. Share Capital: 38,679,664 €, RCS Angoulême 338 567 258.