

STANDARD ACCESSORIES DATA



TEKSAN gensets equipped with fully closed, maintenance free lead acid batteries.

TEKSAN selects batteries according to engine manufacturer’s recommendation and to comply NFPA requirements.



Genset Model	BATTERY			Genset Model	BATTERY		
	CCA	Size	Type		CCA	Size	Type
TJUG25PS	700A	(1)75Ah	LB3	TJUG275PD	860A	(2)102Ah	L5
TJUG40PS	700A	(1)75Ah	LB3	TJUG300PD	860A	(2)102Ah	L5
TJUG60PS	700A	(1)75Ah	LB3	TJUG350PD	860A	(2)102Ah	L5
TJUG80PS	700A	(1)75Ah	LB3	TJUG400PD	860A	(2)102Ah	L5
TJUG100PS	700A	(1)75Ah	LB3	TJUG450PD	860A	(2)102Ah	L5
TJUG115PS	860A	(1)102Ah	L5	TJUG500PD	860A	(2)102Ah	L5
TJUG125PS	860A	(1)102Ah	L5	TJUG600PS	(2)860A	(4)102Ah	L5
TJUG150PS	860A	(1)102Ah	L5	TJUG650PS	(2)860A	(4)102Ah	L5
TJUG200PS	860A	(2)102Ah	L5	TJUG800PS	(2)860A	(4)102Ah	L5
TJUG200PD	860A	(2)102Ah	L5	TJUG1000PS	(2)860A	(4)102Ah	L5
TJUG250PS	860A	(2)102Ah	L5	TJUG1050PS	(2)860A	(4)102Ah	L5

Type	BATTERY DIMENSIONS		
	L	W	H
NS60	238mm	129mm	224mm
	9.4in	5.1in	8.8in
LB3	278mm	175mm	175mm
	11in	6.9in	6.9in
L5	352mm	175mm	190mm
	13.9in	6.9in	7.5in

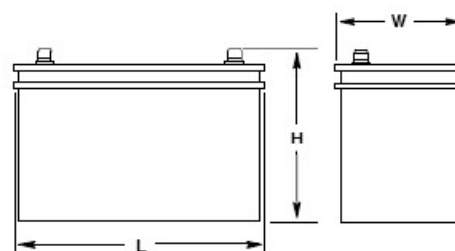

Attention: Batteries must always be kept under a buffer charge. Batteries on a genset that is stored for a long period of time, must be re-charged to prevent corruption on battery plates and become out of use.



BATTERY TECHNICAL DATA SHEET		Date: 24/05/2013		
		Number: 1		
CUSTOMER: Teksan		TYPE: L5		
INCI Reference : 1005886		12 V 102 AH 860A (EN)		
DIMENSION : 352*175*190 (L*W*TH)				
CONTAINER	Box	Color:	GREY	
		Hold Down:	B13	
		Material:	PP	
Lid		Type:	SEALED	
		Polarity:	0	
		Color:	GREY	
		Material:	PP	
Plug		Type:	6x1 Plug set	
		Color:	GREY	
		Material:	PP	
CELL	Plate number per cell	Positive:	10	
		Negatives:	10	
	Plate dimensions	Height x Length:	100x144 mm	
		Positive thicknes:	1.76mm	
		Negative thickness:	1.48mm	
	Grid Alloy	Positives:	PbSbCa	
Negatives:		PbCa		
Separator	Type:	PE		
	Thickness:	0.9 mm		
	Enveloped plate:	Negative		
Plate Blocking	Hot Melt on top:	NO		
MASS	Total battery :	22,93	kg (MAX)	

DSE9470 MKII BATTERY CHARGER

TEKSAN’s DSE9470 MKII is an intelligent switch-mode battery charger fully configurable for use at 12 V or 24 V / 5 Amp or 10 Amp.

The charger features automatic voltage detection and battery voltage sensing down to 1 Volt and has an output current range down to 1 A. The charger can also be easily programmed for different charging curves, to maximise the life of a battery.

The charger continues to operate during cranking and running and accepts multiple AC voltage connections.

The chargers stylish design includes three coloured LEDs to indicate charging status and fault conditions.

The chargers do not include any moving parts for additional durability and reliability. Each charger will continue to operate during engine running.

Multiple chargers can be linked together to provide a larger current output where required.

The battery chargers are programmed using the user-friendly, **non-proprietary DSE Configuration Suite PC software.**



SPECIFICATIONS

<p>AC SUPPLY VOLTAGE RANGE 90 V to 305 V (L to N)</p> <p>FREQUENCY RANGE 48 Hz to 64 Hz (L to N)</p>	<p>DSE9470 MKII DC OUTPUT 10 A DC at 24 V DC (Configurable)</p> <p>RIPPLE AND NOISE <1%</p> <p>EFFICIENCY >86%</p>	<p>REGULATION LINE <0.5%</p> <p>LOAD 2%</p>	<p>TEMPERATURE SENSOR INPUT PT1000</p> <p>CHARGE FAILURE RELAY 3 A at 30 V DC volt free relay</p>
<p>PROTECTIONS Short circuit DC over voltage DC over current Reverse polarity Over temperature AC under & over voltage</p>	<p>DIMENSIONS OVERALL 70 mm x 200 mm x 130 mm</p> <p>2.7" x 7.9" x 5.1"</p> <p>WEIGHT 0.75 kg</p>	<p>OPERATING TEMPERATURE RANGE -30 °C to +70 °C -22 °F to +158 °F</p>	<p>STORAGE TEMPERATURE RANGE -30 °C to +70 °C -22 °F to +158 °F</p>
<p>ELECTRO-MAGNETIC COMPATIBILITY BS EN 61000-6-2 EMC Generic Immunity Standard for the Industrial Environment BS EN 61000-6-4 EMC Generic Emission Standard for the Industrial Environment</p>	<p>OPERATING TEMPERATURE RANGE BS EN 60068-2-1 Ab/Ae Cold Test - 30 °C BS EN 60068-2-2 Bb/Be Dry Heat +80 °C * Refer to de-rating curve in the DSE9000 Operator Manual</p>	<p>HUMIDITY BS EN 60068-2-30 Db Damp Heat Cyclic 20/55 oC @ 95% RH 48 Hours BS EN 60068-2-78 Cab Damp Heat Static 40 oC @ 93% RH 48 Hours</p>	<p>VIBRATION BS EN 60068-2-6 Ten sweeps in each of three major axes 5 Hz to 8 Hz @ +/- 7.5 mm, 8 Hz to 500 Hz @ 2 gn</p> <p>SHOCK BS EN 60068-2-27 Three shocks in each of three major axes 15 gn in 11 mS</p>

DSE9470 MKII INTELLIGENT BATTERY CHARGER

ADVANCED FEATURES

- Intelligent three and four stage charging profiles
- Configurable to suit 12V and 24V applications
- Adjustable current limit
- Can be used as a battery charger, power supply or both at the same time
- Automatic or manual boost and storage charge functions to help maintain battery condition
- Digital microprocessor technology
- Temperature compensation for battery charging
- Low output ripple and superb line regulation
- Three LED indicators • Switched mode design
- Fully customizable battery charging curves • Battery health check
- Battery voltage sensing
- Deep sleep mode
- PSU only mode
- Automatic voltage detection
- Wide output current range

Full Protection

- AC input under voltage
 - AC input over voltage
 - Battery charger output over voltage
 - Battery charger output over current
 - Battery under voltage alarm
 - Automatic battery detection
 - Automatic battery charger self test
 - Output short circuit and inversion polarity with auto recovery
 - Max current mode
 - SCADA digital input status information
 - Automatic power de-rating at high ambient temperatures.
 - Optional battery temperature compensation using PT1000 temperature sensor with over temperature protection
- Automatic Boost Mode**
- Boosts and equalises cell charge, improving battery performance and life
- Power Save Mode**
- Once the battery is fully charged, the chargers switch to eco-power to save energy.

Communication

- Can be integrated into external systems through MODBUS RTU using RS485
- Fully configurable via DSE Configuration Suite PC Software
- External remote display option - DSE2541

KEY BENEFITS

- Fully flexible to maximize the life of the battery
- Suitable for a wide range of battery types
- Minimum 86% efficiency throughout full operating range
- No external intervention for boost mode
- Multiple chargers can be linked together to provide larger current output
- Can be permanently connected to a battery and AC supply. No need to disconnect through high load conditions such as cranking or when the engine is running.

COMPREHENSIVE FEATURE LIST TO SUIT A WIDE VARIETY OF BATTERY CHARGER APPLICATIONS

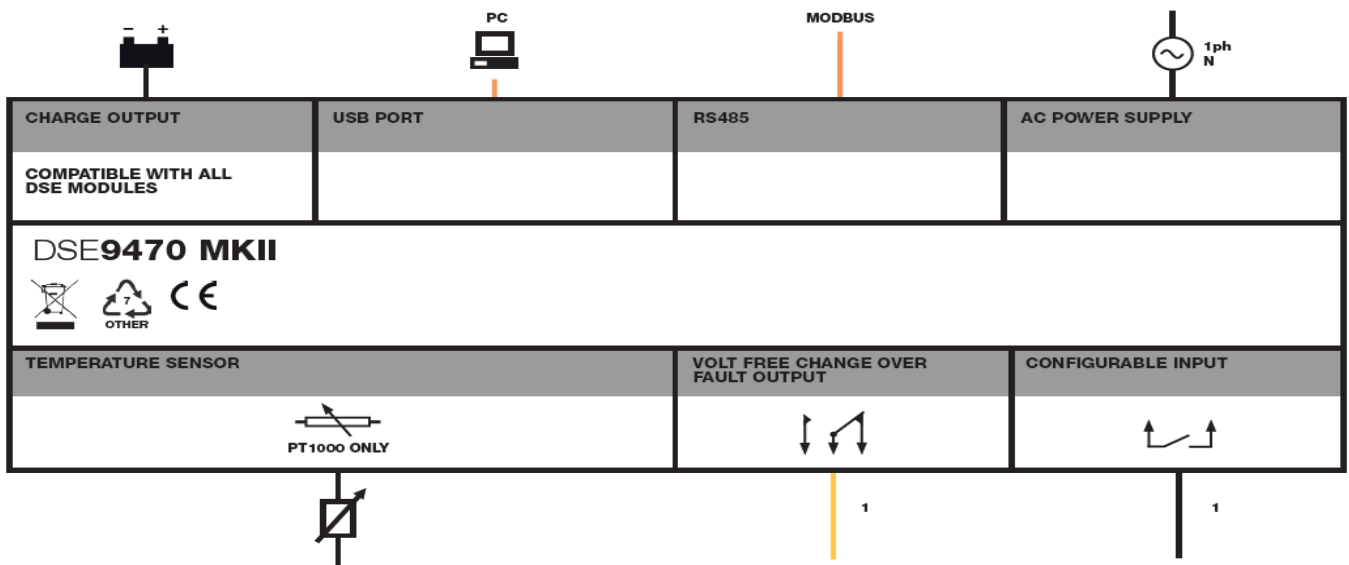

CE PC UL LISTED EASA ANPS IPC MEMBER NFPA 20 (QWIR2)



HOTflow® Heating System CKM



Hotstart's CKM HOTflow® heating system is a coolant preheater, developed to maintain optimal temperatures for diesel and gas engines in stationary land power, marine, construction equipment and truck applications.



INTEGRATED DESIGN

The CKM's mechanically-driven pump is integrated directly into the stainless steel heating tank using a custom designed volute – maximizing coolant flow while minimizing the heater's footprint.



ENERGY EFFICIENT

Like all HOTflow® heaters, the CKM is an energy efficient alternative to legacy convection-based heaters for common genset and heavy equipment engine size applications. Pump-driven forced circulation allows for even, consistent heating while lowering overall operating costs.



USER FRIENDLY

With the technician in mind, the CKM is constructed to provide easy access to all major components. A built in bleed screw allows installers to flush air from the heater before operation and an integrated high-limit thermostat can be manually reset without the need for expensive maintenance.



SIMPLE UPGRADE OPTION

Combined with its ability to be installed horizontally or vertically, the CKM's compact configuration makes it an easy drop-in replacement for traditional convection-based systems.



HOTflow[®] Heating System
CKM

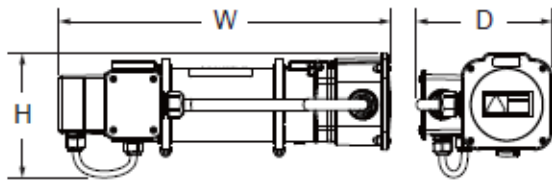

Height (H)	Width (W)	Depth (D)	Weight
6.9"	18.4"	8.5"	13.2 lbs
175 mm	467 mm	216 mm	6.0 kg

System	
Phase	single-phase (1 Ø)
Voltage (60 Hz)	120V 240V
Voltage (50 Hz)	230V
Terminal Box Ingress	IPX6
Motor Ingress (UL-recognized)	NEMA 2
Motor Ingress (CE-compliant)	IP44
Min./Max. Ambient Temp	-40°F / 104°F (-40°C / 40°C)
Vibration Specification	Meets IEC 60068-2-64
Shock Specification	Meets IEC 60068-2-27
Max Pressure	125 psi (860 kPa)
Certification	UL/C-US recognized models available (E250789) CE-compliant models available

Coolant	
Fluid Type	Water Coolant mix (50% water/50% glycol)
Heat Power	3 kW 4 kW 5 kW 6 kW
Temp. Control	Fixed, 100 – 120 °F (38–49°C)
Temp. High Limit	205 °F (96°C)
Pump Power	70 W (50 Hz) / 97 W (60 Hz)
Flow	9 gpm @ 10 ft H ₂ O (34.1 L/min @ 3 m H ₂ O)
Inlet/Outlet	SAE J1926/1:1 5/16-12 (SAE #16 STOR)

Ordering Information
CKM

Engine Displacement	Power Supply		Heating System		
	V	Hz	kW	Amps	Model Number
1000–1500 CID 15–23L	120	60	3	25.0	CKM1030160-000
	230	50	3	13.0	*CKM1030250-000
	240	60	3	13.0	CKM1030260-000
1500–2000 CID 23–30L	230	50	4	13.0	*CKM1040250-000
	240	60	4	16.7	CKM1040260-000
2000–2500 CID 30–38L	230	50	5	21.7	*CKM1050250-000
	240	60	5	20.8	CKM1050260-000
2500–3000 CID 38–50L	230	50	6	26.1	*CKM1060250-000
	240	60	6	25.0	CKM1060260-000

* – CE-compliant
(All other models – UL/C-US recognized)

Optional Inlet/Outlet Adapter Fittings (CKM Models only)			
From	To	Part Number	Part Description
SAE #16 STOR	0.75" hose barb	HB-16STORX3/4HB	#16 STOR to 3/4" hose barb adapter. Installs in #16 STOR female inlet or outlet of heater.
SAE #16 STOR	1.0" hose barb	HB-16STORX1HB	#16 STOR to 1" hose barb adapter. Installs in #16 STOR female inlet or outlet of heater.

LEROY – SOMER DIGITAL AVR

REGULATORS AND EXCITATION SYSTEMS ARE AT THE HEART OF INDUSTRIAL ALTERNATORS PERFORMANCE AND RELIABILITY.

While there is a wide range of Analogue AVRs to provide reliable excitation and regulation for Shunt, AREP or PMG alternators, Leroy-Somer have designed digital voltage regulators to integrate easily in complex systems, providing regulation and security features to ensure optimal performance of the installation.

TEKSAN use D350 model Digital AVR as standard in its UL2200 Listed generator sets.

LEROY-SOMER AVR RANGE & FEATURES	D350	D550	D700	R120	R150	R180	R220	R250
Technology	Digital			Analog				
SHUNT	✓	✓	✓	✓	✓		✓	✓
AREP / AREP+	✓	✓	✓			✓		
PMG	✓	✓	✓			✓		
Rated Excitation Current (A, 55°C)	5	8	20	4	6	6	3.2	5
Regulation Accuracy (± %)	0.25	0.25	0.25	1	0.8	0.5	0.5	0.5
Voltage Setting Range (± %)	30	30	30	10	10	5	5	5
Paralleling Between Gensets	✓	✓	✓		✓	✓		
Three Phase Sensing	✓	✓	✓					
LAM	✓	✓	✓					✓
Over-excitation Limitation	✓	✓	✓	✓	✓			
Short Circuit Current Limitation	✓	✓	✓					
Grid paralleling (PF / kVAr)		✓	✓					

The D350 digital AVR for industrial alternators provides excitation current up to 5 A with excellent reliability for both PMG and AREP Excitation system.

D350 includes advanced protections such as over-excitation limitation and voltage sensing loss. It also includes speed detection capabilities, with over- and under-speed alarms. D350 also features voltage droop for genset parallel operation, and it is equipped with a Load Acceptance Module (LAM) to handle load impact events.



LEROY – SOMER DIGITAL AVR

REGULATION FEATURES

PID - PID is the regulation system function which combines different rules (Proportional, Integral, Derivative) to stabilize the current produced by the alternator. Tuning this function allows to optimize the response time of the system to reach the voltage set point, or to stabilize it quickly in case of fluctuations. It is an essential component of any regulation system.

U/f function - U/f is a function designed to handle underspeed situations. It allows to adapt the alternator voltage according to the rotation speed of the prime mover. If the system speed is lower than the nominal speed, the alternator voltage is reduced. This prevents saturation in the excitation system and protects the alternator rotor from any damage.

LAM function - The LAM (Load Acceptance Module) is a function that adapts the alternator voltage according to the rotation speed of the prime mover. It is triggered in the event of a load impact. The LAM considerably reduces the alternator voltage which results in decreased power demand on the prime mover.

As the speed climbs back to normal, the alternator voltage re-established.

Three-phase sensing - The regulator needs voltage measurement in order to maintain the voltage on the alternator output terminals. Three phases sensing means that voltage detection and measurement is done on all three phases of the alternator, which allows to regulate the average voltage. This means that regulation is more precise and safer.

Short circuit current limitation - The short circuit current limitation is triggered during short circuits. It is adjusted on the regulator and allows to limit the delivered current during 10 seconds maximum. This prevents the alternator from getting damaged by a too strong current.

EASYREG ADVANCED

EasyReg Advanced is the dedicated software to configure and monitor Leroy-Somer digital Automatic Voltage Regulators (AVR). It is compatible with the D350, D550 and D700.

EasyReg Advanced includes a complete set of tools:

- Step-by-step configuration of the alternator parameters, regulation modes, limits, wiring, PID, I/O and protection devices.
- Monitoring and analysis tools, including an oscilloscope, a monitoring panel, and harmonic analysis.
- Grid code protection parameters definition and synchronization parameters for grid paralleling

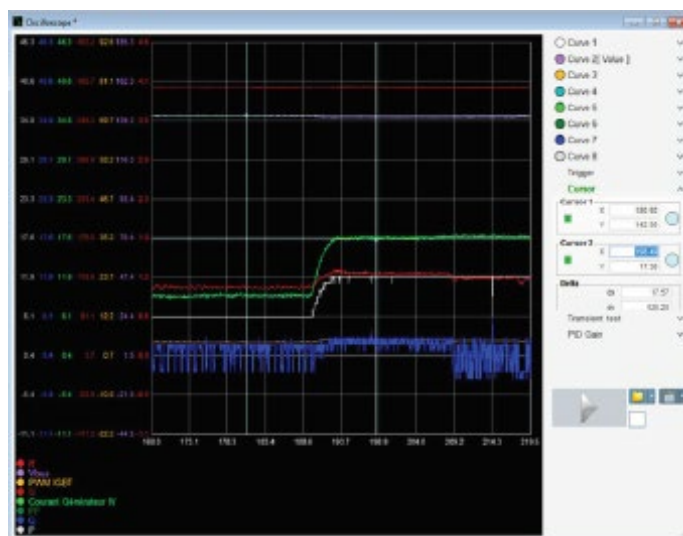

D350 DIGITAL AVR

FOR ALTERNATORS WITH SHUNT, AREP OR PMG EXCITATION

CHARACTERISTICS

- Rated excitation current: 5 A
- Maximum excitation current: 10 A for 10 s
- Voltage regulation accuracy: $\pm 0.25\%$
- Excitation: SHUNT, AREP or PMG
- Voltage sensing: three-phase or single-phase - 530 VAC max.
- CT input: yes (1 A and 5 A)
- Mate N Lok connectors

MAIN FUNCTIONS

- Quadrature droop function
- Over-excitation protection
- Loss of sensing
- Stator current monitoring
- U/F
- LAM function
- Soft Start function
- Voltage soft recovery
- Two configuration modes can be activated by a digital input (eg. 50/60 Hz)
- Event logger

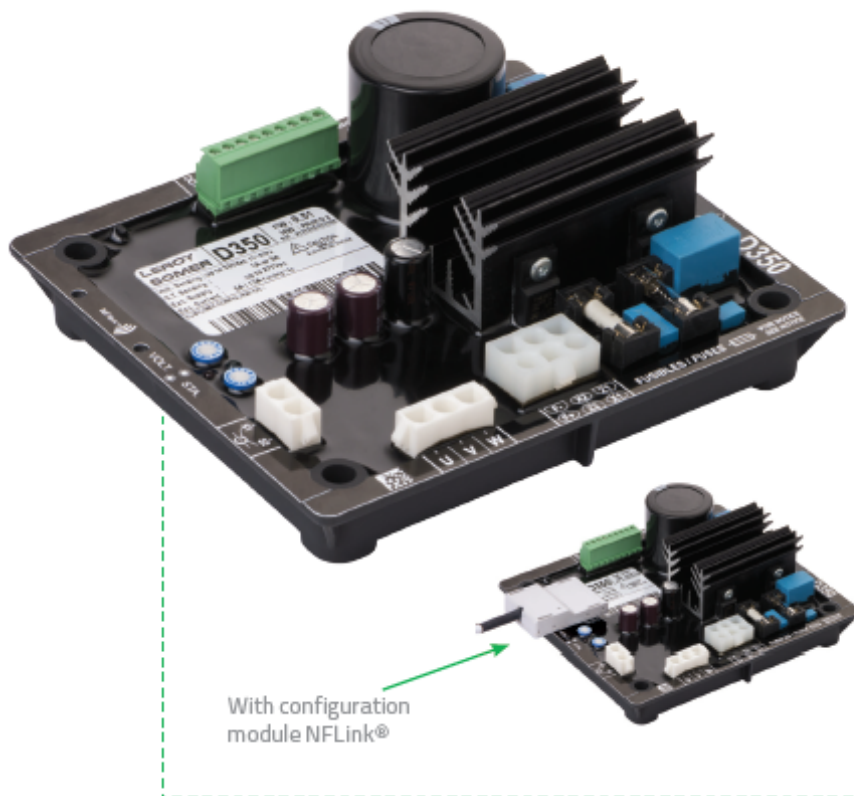

The D350 is a digital automatic voltage regulator (AVR) for alternators which require rated field current up to 5 A.

It offers numerous control and protection functions for the various components of generator sets, especially for managing short-circuits and load impacts.

The D350 can be configured using the Leroy-Somer EasyReg Advanced software.

For easier maintenance and investigations in the event of problems, the D350 also offers an event logger function and an NLink® wireless communication module for setting parameters and retrieving data.

The D350 conforms to standard IEC 60034-1 and is certified UL508 and CSA.

CONNECTIONS AND COMMUNICATION

- Inputs
 - 1 x analog input
 - 1 x digital input
 - 1 x thermal sensor input (configurable in PT100 or PTC)
- Outputs
 - 2 x digital outputs
- Event logger
- NLink® module for configuration
- Mate N Lok connectors

CONDITIONS OF USE



- Operation: -40°C to +65°C
- Storage: -55°C to +85°C
- Relative humidity: up to 98%
- Maximum impact: 9 g on all 3 axes

COMPATIBILITY

	LSA 40	LSA 42.3	LSA 44.3	LSA 46.3	LSA 47.2	LSA 49.3	LSA 50.2
SHUNT	✓	✓	✓	✓	✓	✓	✓
AREP	✓	✓	✓	✓	✓	✓	✓
PMG		✓	✓	✓	✓	✓	✓
	TAL 040	TAL 042	TAL 044	TAL 046	TAL 0473	TAL 049	
SHUNT	✓	✓	✓	✓	✓	✓	
AREP	✓	✓	✓	✓	✓	✓	
PMG		✓	✓	✓	✓	✓	

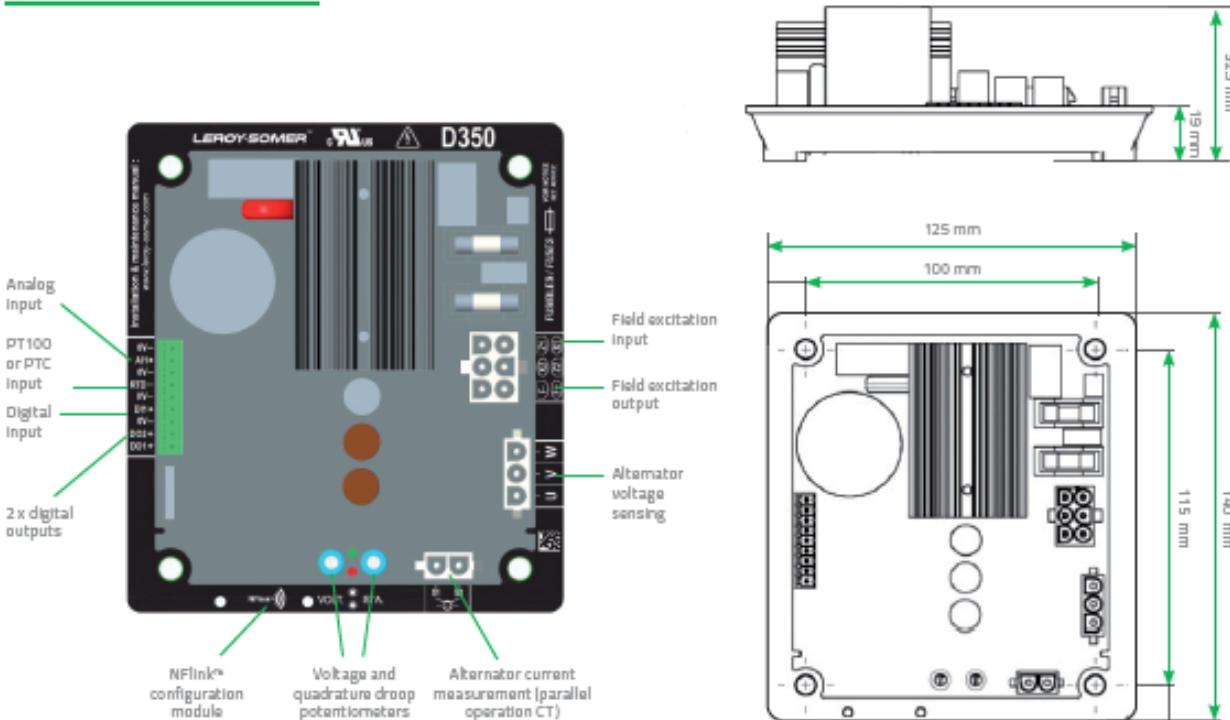
DIMENSIONAL DRAWING



	
	
B200E	
Contact	1NC
Model	Emergency
Product	Control Unit
Short Circuit Breaking Capacity	Ics 1 kA
Screw Torque	1,5 Nm
Dielectric Strength (Contact-Contact)	1.500V AC
Dielectric Strength (Body-Contact)	2.500V AC
Impulse Withstand Voltage	Uimp 2.5 kV
Insulation Voltage	Ui 300V
Operating Frequency	On-Off/Hour Mech. 1200 Elec. 1200
Electrical Life	Min Qty 100000
Mechanical Life	Min Qty 500000
Usage Category	AC 15
Current	Ie 4 A (250V AC)
Head Dia	40 mm
Dia	22 mm
Color	Red
Type	Turn to Release
Isolation Resistance	10 MΩ min. (500V DC)
Operating Temperature	-15 / + 80 °C
Pollution Degree	3
Protection Degree	IP50
Contact Material	AgNi
Cable Section	1.5-2.5 mm ²
Serial	B Series Plastic
Specifications	Non-flammable V0 PA6.6 contact blocks Various illumination contact blocks availability Variety of products for all areas of application
Standards / Certificates	IEC 60947-5-1 TS EN 60947-5-1 UL 508 VDE 0660
	

Description

Legacy Power Relays

389F
 SPST, 30 A; DPDT, 20–25 A;
 SPDT, 25–30 A; 3PDT, 20 A

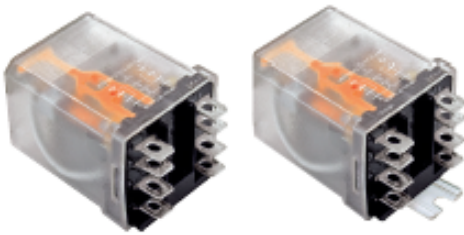

Plug-In (Socket) Cover

Side Flange Cover

Description

The 389F series power relays offer a broad range of contact ratings along with a variety of mounting options and accessories, making it the ideal solution for a variety of application requirements.

Feature	Benefit
High-power contacts	High contact ratings (up to 30 A, 1.5 hp) and long electrical endurance; suitable for high-power switching applications
Ballast load ratings	Ideal for lighting controls
Multiple contact configurations	Meets a wide variety of applications
Socket mountable (plug-in cover only)	Helps increase design and installation flexibility; allows the use of modules and other accessories
RoHS compliant	Environmentally friendly; complies with the European Restriction of Hazardous Substances directive

Rated Contact Current	Contact Configuration	Coil Voltage	Coil Resistance (Ω)	Cover Style	Standard Part Number	
20 A	3PDT	12 Vac	17.7	Side flange	389FXCXC1-12A	
		24 Vac	72	Side flange	389FXCXC1-24A	
				Plug-In (socket)	389FXCXC-24A	
		120 Vac	1700	Plug-In (socket)	389FXCXC-120A	
				Side flange	389FXCXC1-120A	
		240 Vac	7200	Plug-In (socket)	389FXCXC-240A	
				Side flange	389FXCXC1-240A	
		12 Vdc	100	Plug-In (socket)	389FXCXC-12D	
				Side flange	389FXCXC1-12D	
		24 Vdc	400	Plug-In (socket)	389FXCXC-24D	
				Side flange	389FXCXC1-24D	
		25 A	DPDT	24 Vac	72	Side flange
120 Vac	1700			Plug-In (socket)	389FBXC-120A	
				Side flange	389FBXC1-120A	
240 Vac	7200			Plug-In (socket)	389FBXC-240A	
				Side flange	389FBXC1-240A	
12 Vdc	100			Plug-In (socket)	389FBXC-12D	
			Side flange	389FBXC1-12D		
24 Vdc	400		Plug-In (socket)	389FBXC-24D		
			Side flange	389FBXC1-24D		
30 A	SPDT		24 Vac	72	Side flange	389FXXC1-24A
			120 Vac	1700	Side flange	389FXXC1-120A
			240 Vac	7200	Side flange	389FXXC1-240A
		12 Vdc	100	Side flange	389FXXC1-12D	
		24 Vdc	400	Side flange	389FXXC1-24D	
		SPDT-DM-DB	24 Vac	72	Side flange	389FXHC1-24A
	120 Vac		1700	Side flange	389FXHC1-120A	
	240 Vac		7200	Side flange	389FXHC1-240A	
	12 Vdc		100	Side flange	389FXHC1-12D	
	24 Vdc		400	Side flange	389FXHC1-24D	
	SPST-NO-DM		24 Vac	72	Side flange	389FHXC1-24A
		120 Vac	1700	Side flange	389FHXC1-120A	
240 Vac		7200	Side flange	389FHXC1-240A		
12 Vdc		100	Side flange	389FHXC1-12D		
24 Vdc		400	Side flange	389FHXC1-24D		

Specifications

Legacy Power Relays

389F

SPST, 30 A; DPDT, 20–25 A;

SPDT, 25–30 A; 3PDT, 20 A

Specifications

Part Number	389FXAX, XBX	389FXCX	389FXHX, HXX
Contact Characteristics			
Contact Configuration	SPDT, DPDT	3PDT	SPST-NO-DM; SPDT-DM-DB
Contact Material	Silver alloy		
Thermal (Carrying) Current	25 A	20 A	30 A
Maximum Switching Voltage	600 V	300 V	600 V
Rated Switching Current at Voltage (Conforming to IEC AC-1 and DC-1)	NO and NC: 25 A at 250 Vac NO and NC: 15 A at 28 Vdc	NO and NC: 20 A at 250 Vac NO and NC: 15 A at 28 Vdc	NO and NC: 30 A at 250 Vac NO and NC: 30 A at 28 Vdc
Current Ratings at Voltage (Conforming to UL)	Resistive: 25 A at 300 Vac 50/60 Hz; 5 A at 600 Vac 50/60 Hz; 13 A at 28 Vdc, 100,000 cycles Motor: 1.5 hp at 200–240 Vac 50/60 Hz; 1 hp at 120–200 and 480–600 Vac ² 50/60 Hz, 6,000 cycles Pilot Duty: B600, 6,000 cycles FLA/LRA: 22/98 A at 120 Vac, 6,000 cycles Ballast: 20 A, 277 Vac 50/60 Hz, 6,000 cycles	Resistive: 20 A at 150 Vac 50/60 Hz, 15 A at 250 Vac, 50/60 Hz 13 A at 28 Vdc, 50,000 cycles Motor: 0.5 hp at 120–240 Vac 50/60 Hz; 6,000 cycles Pilot Duty: B300, 6,000 cycles Ballast: 20 A, 150 Vac 50/60 Hz; 6.67 A at 277 Vac, 6,000 cycles	Resistive: 30 A at 300 Vac 50/60 Hz; 10 A at 600 Vac 50/60 Hz 30 A at 28 Vdc, 100,000 cycles Motor: 1.5 hp at 200–600 Vac 50/60 Hz; 1 hp at 120–200 Vac 50/60 Hz, 6,000 cycles Pilot Duty: A600, 6,000 cycles FLA/LRA: 22/98 A at 120 Vac, 6,000 cycles; 17/60 A at 300 Vac, 6,000 cycles ³ Ballast: 25 A, 277 Vac 50/60 Hz, 6,000 cycles
Minimum Switching Requirement	100 mA at 5 Vdc		
Coil Characteristics			
Coil Voltage Range ¹	12–240 Vac 50/60 Hz; 12–24 Vdc ¹		
Operating Range (% of Nominal)	85%–110% (AC); 80%–110% (DC)		
Average Consumption	2 VA (AC); 1.5 W (DC)		
Drop-out Voltage Threshold	10% minimum (AC/DC)		
General Characteristics			
Electrical Life at Rated Load ²	100,000 operations for IEC AC-1, 50,000 operations for IEC DC-1		
Mechanical Life at No Load (Unpowered)	5,000,000 operations		
Operate Time at Nominal Coil Voltage	20 ms (maximum)		
Dielectric Strength	Between coil and contact: 2200 Vac; between poles: 2200 Vac; between contacts: 1600 Vac		
Operating Temperature Range	-30 to +55 °C (-22 to +131 °F)		
Storage Temperature Range	-30 to +85 °C (-22 to +185 °F)		
Weight (Average)	84 g (3.0 oz)		
Agency Certifications	UL Listed (E164862), CSA (225619), CE (per IEC 60947-1), RoHS		

Note: Actual product performance may vary depending on application and environmental conditions.

¹ For available standard coil voltages, refer to the standard part number table on page 14.

² The NO and NC contacts were tested independently. ³ Break all lines for 1 hp at 600 Vac, 50/60 Hz.

³ For SPST-NO-DM version only.

Part Number Explanation

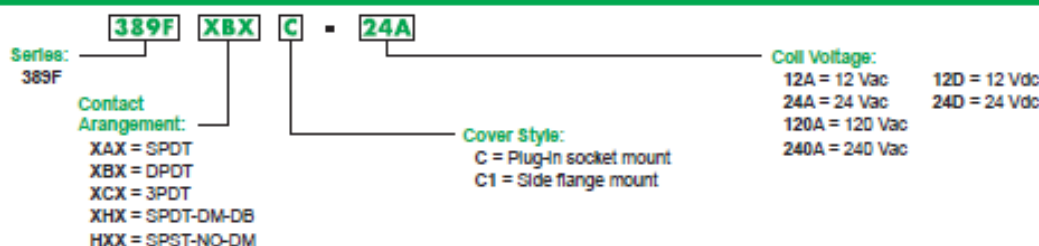

Dimensions,
Wiring Diagrams

Legacy Power Relays

389F
SPST, 30 A; DPDT, 20–25 A;
SPDT, 25–30 A; 3PDT, 20 A

Dimensions — inches (millimeters)

Plug-in Cover Style

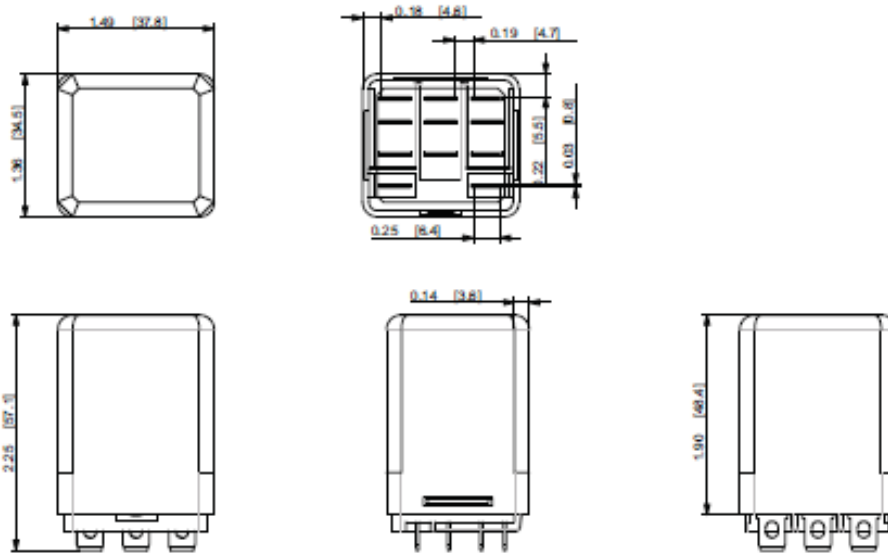

Side Flange Cover Style

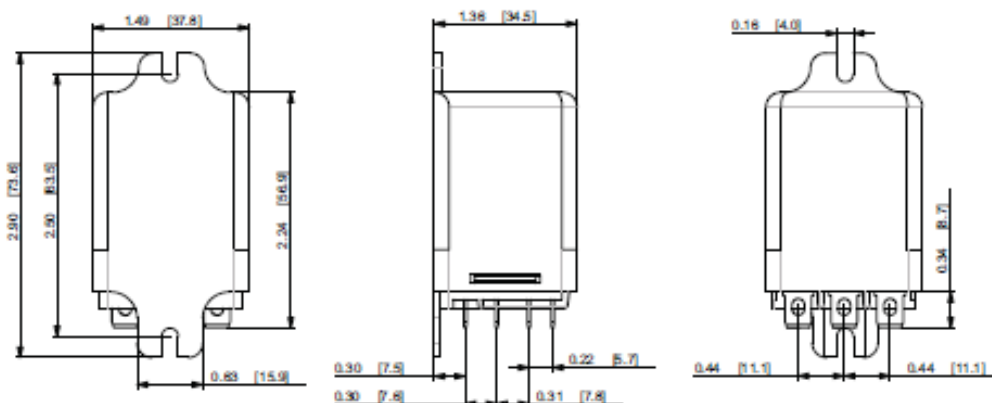

Wiring Diagrams

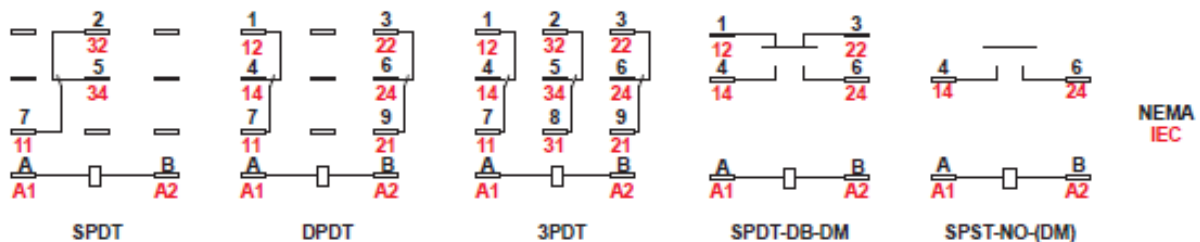

Accessories

Legacy Power Relays

389F
Socket, 70-788EL11-1



Description

The 389F accessories create a complete system solution for all your application needs.



Relay Accessories

Description	Function	For Use with Relays	Packaging Minimum	Standard Part Number
Socket	Offers an alternate installation option	389F relays with plug-in (socket) cover	10	70-788EL11-1

Socket Accessories

Description	Function	Coil Voltage	For Use with Sockets	Packaging Minimum	Standard Part Number
Socket Module*	LED Indicator	120/240 Vac/Vdc	70-788EL11-1	10	70-ASMLG-110/240
	MOV suppressor	24 Vac/Vdc	70-788EL11-1	10	70-ASMM-24
		120 Vac/Vdc	70-788EL11-1	10	70-ASMM-120
	Protection diode	240 Vac/Vdc	70-788EL11-1	10	70-ASMM-240
		RC circuit	6-250 Vdc	70-788EL11-1	10
ID Rail clip	Identification of circuits in multi-relay applications	240 Vac	70-788EL11-1	10	70-ASMR-240
Panel Mount Adapter	Mounting socket to a panel	N/A	70-788EL11-1	10	16-750/788FT-1
Meta DIN Rail	Quick installation and removal of sockets	N/A	70-788EL11-1	10	16-788C1
DIN Rail Clip	Holds sockets firmly in place on DIN rail	N/A	70-788EL11-1	20	16-700DIN
				10	16-DCLIP-1

* Use of LED or RC socket module may increase coil power draw by up to 10%. See page 30 for more information.

Socket Specifications (UL 508)

Part Number	70-788EL11-1
Number of Terminals	11
Nominal Voltage Rating	300 V
Nominal Current Rating	25 A
Dielectric Strength	Between adjacent output terminals: 3000 V(rms); Output to input terminals: 3000 V(rms); Terminals to rail/chassis: 3000 V(rms)
Temperature Range	Operation: -40 to +80 °C (-40 to +176 °F); Storage: -40 to +105 °C (-40 to +221 °F)
Protection Category (Fingersafe™)	IP20
Internal Metal Tracks	Copper alloy, Tin plated
Screw Terminals	Steel, Zinc plated combination head
Maximum Screw Torque	9.0 lb-in (1.0 N-m)
Mounting Style	35 mm DIN rail; mounts to panel with 16-788C1 adapter
Wire Connection Method	Elevator terminals
Wire Size	Solid Cu: two 10-12 AWG (4.0-6.0 mm ²) Stranded Cu: two 10-12 AWG (4.0-6.0 mm ²)
Flammability Rating	94V-0
Weight	3.39 oz (96 g)
Agency Certifications	UL Listed (E70550), CSA (40787), CE (per IEC 61984), RoHS



Relay Mounting Example

Dimensions

Legacy Power Relays

389F
Socket, 70-788EL11-1

Dimensions — inches (millimeters)

70-788EL11-1

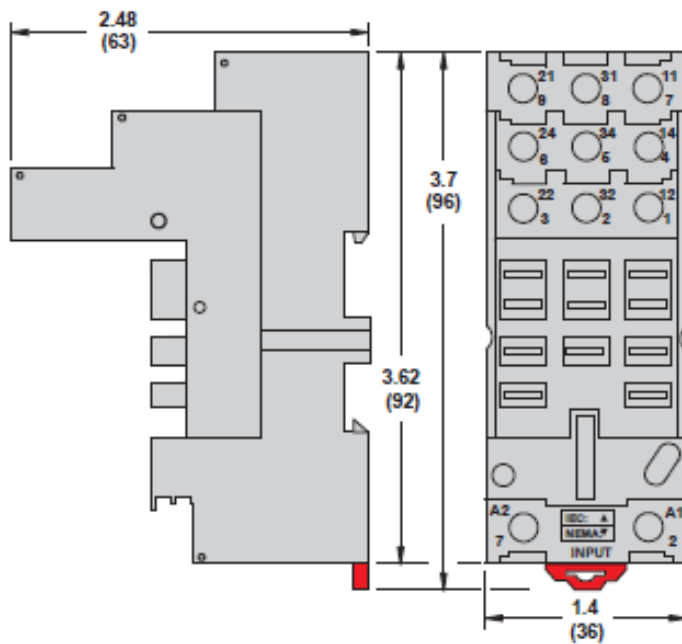

16-788C1 Panel Mount Adapter for 70-788EL11 socket

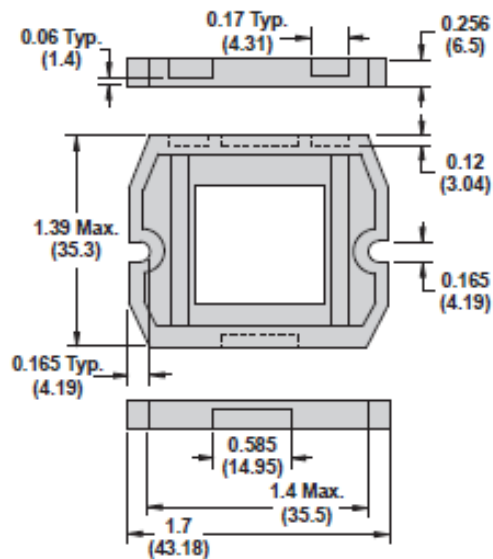

Wiring Diagram

70-788EL11-1

