

ALTERNATOR DATA

 **TEKSAN**

LEROY-SOMER™

Nidec
All for dreams

TAL 042 - Three-phase & Single-phase

The best of performance

Nidec Leroy-Somer TAL 042 alternator has been designed to offer you the best power generation performances. With its meticulous design and optimized architecture, the TAL 042 strikes the perfect balance between compactness, reliability, performance and longevity. Whatever your application, the TAL 042 will meet your needs and will adapt to all situations.

Standards

Nidec Leroy-Somer TAL 042 alternator meets all key international standards and regulations, including IEC 60034, NEMA MG 1.32-33, ISO 8528-3, CSA C22.2 n°100-14 and UL 1446 (UL 1004 on request). Also compliant with IEC 61000-6-2, IEC 61000-6-3, IEC 61000-6-4, VDE 0875G, VDE 0875N and EN 55011, group 1 class A for European zone. Nidec Leroy-Somer TAL 042 alternator can be integrated in EC marked generator set, and bears EC, EAC and CMIM markings. It is designed, manufactured and marketed in an ISO 9001 and ISO 14001 quality assurance environment.

Electrical characteristics and performances

- Class H insulation
- Shunt excitation
- Low voltage winding:
 - Three-phase 50 Hz: 220V - 240V and 380V - 415V (440V)
 - 60 Hz: 208V - 240V and 380V - 480V
 - Single-phase 50 Hz: 115V - 230V
 - 60 Hz: 120V - 240V
- 4-terminal plates in 8-wire version
- Optimized performance

Excitation and regulation system

	Excitation system				Regulation options	
	AVR	SHUNT	AREP+ (option)	PMG (option)	UL _{cus}	Remote voltage potentiometer
Three-phase 6-wire	R120	Standard				
	R150	Option				✓
	R180		Standard	Standard		✓
Three-phase 12-wire	D350	Option	Option	Option	✓	✓
	R120	Standard				
	R220	Option			✓	✓
	R180		Standard	Standard		✓
Single-phase	D350	Option	Option	Option	✓	✓
	R121	Standard				✓
	R221	Option			✓	✓

Protection system and options

- Degree of protection: IP 23
- Complete winding protection for non-harsh environment with relative humidity ≤ 95%
- Options:
 - Three-phase 12-wire with 8-terminal plates
 - AREP+ or PMG excitation
 - UL_{cus}
 - Customized painting (unpainted machine as standard)
 - Space heater
 - Flying leads
 - Dedicated single-phase
 - Winding 8 optimized for three-phase 380V / 416V - 60Hz
 - Reinforced winding protection for harsh environments and relative humidity greater than 95% (system 2 - 4): derating according to the following table

Type	50 Hz			60 Hz
	380V	400V	415V	All voltages
TAL 042	0.97	1 except 0.97 for TAL 042 G & H	1 except 0.97 for TAL 042 G & H	1 except 0.97 for TAL 042 G & H

Mechanical construction

- Compact and rugged assembly to withstand engine vibrations
- Steel frame
- Aluminum flanges and shields
- Single-bearing design compatible with most diesel engines
- Greased for life bearings
- Direction of rotation: clockwise and counterclockwise without derating

Terminal box design

- Easy access to AVR and terminals



TAL 042 - Three-phase 25 to 60 kVA - 50 Hz / 31.5 to 75 kVA - 60 Hz

General characteristics

Insulation class	H	Excitation system 6-wire	SHUNT	AREP+ / PMG
Winding pitch	2/3 (wind.6S - 6-wire / wind.6 - 12-wire)	AVR type	R120	R180
Number of wires	6 (12 option)	Excitation system 12-wire (option)	SHUNT	AREP+ / PMG
Protection	IP 23	AVR type	R120	R180
Altitude	≤ 1000 m	Voltage regulation (**)	± 1 %	± 0.5 %
Overspeed	2250 R.P.M.	Total Harmonic Distortion THD (***) in no-load		< 2 %
Air flow 50 Hz	0.10 m³/s	Total Harmonic Distortion THD (***) in linear load		< 5 %
Air flow 60 Hz	0.13 m³/s	Waveform: NEMA = TIF (***)		< 50
AREP+/PMG Short-circuit current = 2.7 In: 5 seconds (*)		Waveform: I.E.C. = FHT (***)		< 2%

(*) D350: 10 seconds (**) Steady state (***) Total harmonic distortion between phases, no-load or on-load (non-distorting)

Ratings 50 Hz - 1500 R.P.M.

kVA / kW - P.F. = 0.8																						
Duty / T° C	Continuous / 40 °C					Continuous / 40 °C					Stand-by / 40 °C					Stand-by / 27 °C						
Class / T° K	H / 125° K					F / 105° K					H / 150° K					H / 163° K						
Phase	3 ph.			1 ph.		3 ph.			1 ph.		3 ph.			1 ph.		3 ph.			1 ph.			
Y	380V	400V	415V	440V		380V	400V	415V	440V		380V	400V	415V	440V		380V	400V	415V	440V			
Δ	220V	230V	240V		230V	220V	230V	240V		230V	220V	230V	240V		230V	220V	230V	240V		230V		
YY (*)	200V		220V			200V		220V			200V		220V			200V		220V			200V	
ΔΔ (*)	230V					230V					230V					230V						
TAL 042 A	kVA	25	25	25	24.5	15	23	23	23	22.5	13.5	26.5	26.5	26.5	26	16	27.5	27.5	27.5	27	16.5	
	kW	20	20	20	19.5	12	18.5	18.5	18.5	18	11	21	21	21	21	13	22	22	22	21.5	13	
TAL 042 B	kVA	27	27	27	26	16	24.5	24.5	24.5	23.5	14.5	28.5	28.5	28.5	27.5	17	30	30	30	28.5	17.5	
	kW	21.5	21.5	21.5	21	13	19.5	19.5	19.5	19	11.5	23	23	23	22	13.5	24	24	24	23	14	
TAL 042 C	kVA	31	32	32	30	19	28	29	29	27.5	17.5	33	34	34	32	20	34	35	35	33	21	
	kW	25	25.5	25.5	24	15	22.5	23	23	22	14	26.5	27	27	25.5	16	27	28	28	26.5	17	
TAL 042 D	kVA	35	35	35	30.5	22	32	32	32	28	20	37	37	37	32.5	23.5	38.5	38.5	38.5	33.5	24	
	kW	28	28	28	24.5	17.5	25.5	25.5	25.5	22.5	16	29.5	29.5	29.5	26	19	31	31	31	27	19	
TAL 042 E	kVA	39.5	40	40	35	25	36	36.5	36.5	32	23	42	42.5	42.5	37	26.5	43.5	45	45	38.5	27.5	
	kW	31.5	32	32	28	20	29	29	29	25.5	18.5	33.5	34	34	29.5	21	35	36	36	31	22	
TAL 042 F	kVA	43	45	45	39	27	39	41	41	35.5	24.5	45.5	47.5	47.5	41.5	28.5	47.5	50	50	43	29.5	
	kW	34.5	36	36	31	21.5	31	33	33	28.5	19.5	36.5	38	38	33	23	38	40	40	34.5	23.5	
TAL 042 G	kVA	47.5	50	50	43	30	43	45.5	45.5	39	27.5	50	53	53	45.5	32	52	55	55	47.5	33	
	kW	38	40	40	34.5	24	34.5	36.5	36.5	31	22	40	42	42	36.5	25.5	42	44	44	38	26.5	
TAL 042 H	kVA	58	60	60	52	36	53	55	55	47	33	61	64	64	55	38	64	66	66	57	39.5	
	kW	45	48	48	42	29	42	44	44	37.5	26.5	49	51	51	44	30.5	51	53	53	45	31.5	

(*) 12-wire option

Ratings 60 Hz - 1800 R.P.M.

kVA / kW - P.F. = 0.8																						
Duty / T° C	Continuous / 40 °C					Continuous / 40 °C					Stand-by / 40 °C					Stand-by / 27 °C						
Class / T° K	H / 125° K					F / 105° K					H / 150° K					H / 163° K						
Phase	3 ph.			1 ph.		3 ph.			1 ph.		3 ph.			1 ph.		3 ph.			1 ph.			
Y	380V	416V	440V	480V		380V	416V	440V	480V		380V	416V	440V	480V		380V	416V	440V	480V			
Δ	220V	240V		240V		220V	240V		240V		220V	240V		240V		220V	240V		240V			
YY (*)	208V		220V			208V		220V			208V		220V			208V		220V			208V	
ΔΔ (*)	240V					240V					240V					240V						
TAL 042 A	kVA	29	31.5	31.5	31.5	18.9	26.5	28.5	28.5	28.5	17	30.5	33.5	33.5	33.5	20	32	34.5	34.5	34.5	20.8	
	kW	23	25	25	25	15	21	23	23	23	13.5	24.5	27	27	27	16	25.5	27.5	27.5	27.5	16.5	
TAL 042 B	kVA	30	32	34	34	19.2	27.5	29	31	31	17.5	32	34	36	36	20.5	33	35	37.5	37.5	21.1	
	kW	24	25.5	27	27	15.5	22	23	25	25	14	25.5	27	29	29	16.5	26.5	28	30	30	17	
TAL 042 C	kVA	33.5	37	39	40	23	30.5	33.5	35.5	36.5	21	35.5	39	41.5	42.5	24.5	37	40.5	43	44	25.5	
	kW	27	29.5	31	32	18.5	24.5	27	28.5	29	17	28.5	31	33	34	19.5	29.5	32.5	34.5	35	20.5	
TAL 042 D	kVA	37.5	40.5	43	44	24	34	37	39	40	22	40	43	45.5	46.5	25.5	41.5	44.5	47.5	48.5	26.5	
	kW	30	32.5	34.5	35	19	27	29.5	31	32	17.5	32	34.5	36.5	37	20.5	33	35.5	38	39	21	
TAL 042 E	kVA	41.5	45.5	48.5	50	27.5	38	41.5	44	45.5	25	44	48	51	53	29	45.5	50	53.5	55	30.5	
	kW	33	36.5	39	40	22	30.5	33	35	36.5	20	35	38.5	41	42	23	36.5	40	43	44	24.5	
TAL 042 F	kVA	44	48	51	56.5	30	40	43.5	46.5	51	27.5	46.5	51	54	60	32	48.5	53	56	62	33	
	kW	35	38.5	41	45	24	32	35	37	41	22	37	41	43	48	25.5	39	42	45	50	26.5	
TAL 042 G	kVA	49	53.5	56.5	62.5	34	44.5	48.5	51	57	31	52	57	60	66.5	36	54	59	62	69	37.5	
	kW	39	43	45	50	27	35.5	39	41	48	25	42	46	48	53	29	43	47	50	55	30	
TAL 042 H	kVA	57	65	66.5	75	39	52	59	61	68	35.5	60	69	70	80	41.5	62.5	72	73	82.5	43	
	kW	45	52	53	60	31	42	47	49	54	28.5	48	55	56	64	33	50	58	58	68	34.5	

(*) 12-wire option

TAL 042 - Three-phase 25 to 60 kVA - 50 Hz / 31.5 to 75 kVA - 60 Hz

Efficiencies 480 V - 60 Hz (— P.F.: 0.8) (..... P.F.: 1)

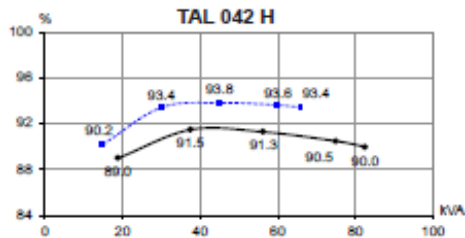
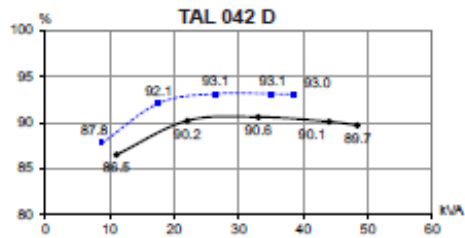
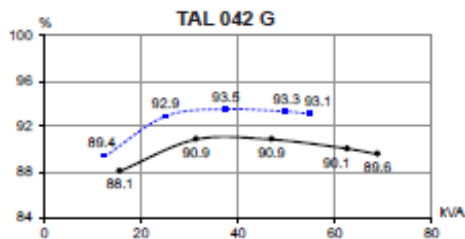
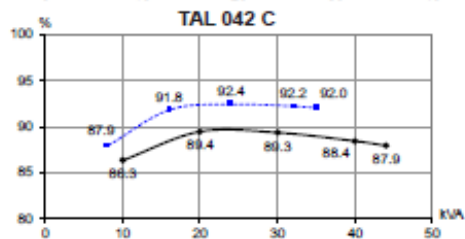
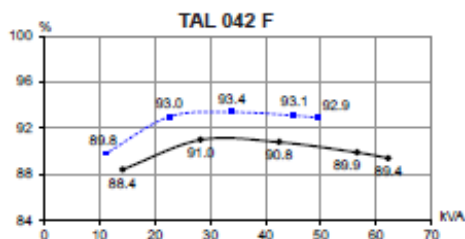
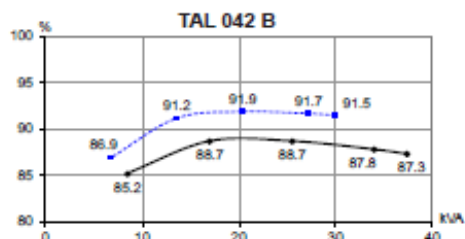
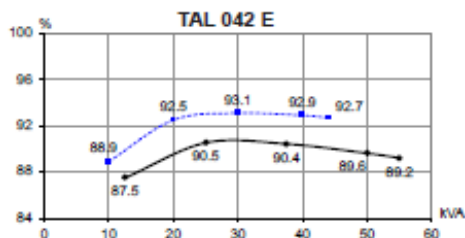
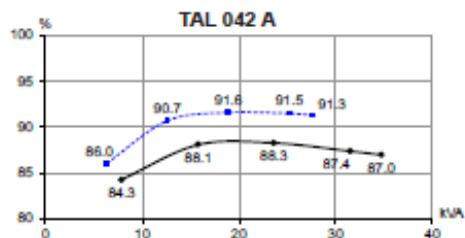

Reactances (%). Time constants (ms) - Class H / 480 V

	A	B	C	D	E	F	G	H
Kcc	0.47	0.44	0.42	0.46	0.41	0.38	0.41	0.38
Xd	270	280	292	257	292	308	295	316
Xq	138	143	148	131	149	157	150	161
T'do	786	813	861	944	944	980	998	1031
X'd	17.2	17.2	16.9	13.6	15.5	15.7	14.7	15.3
T'd	50	50	50	50	50	50	50	50
X''d	8.6	8.6	8.4	6.8	7.7	7.8	7.3	7.6
T''d	5	5	5	5	5	5	5	5
X''q	12.1	12.1	12	9.7	11	11.2	10.5	10.9
Xo	0.71	0.71	0.7	0.56	0.64	0.65	0.61	0.63
X2	10.37	10.4	10.24	8.27	9.39	9.55	8.97	9.3
Ta	8	8	8	8	8	8	8	8

Other class H / 480 V data

Io (A)	0.63	0.60	0.59	0.56	0.56	0.54	0.58	0.48 / 0.74
Ic (A)	2.16	2.15	2.21	1.92	2.17	2.21	2.32	2.04 / 3.13
uc (V)	32.8	32.6	33.3	29	32.4	32.7	34.1	33.6 / 21.5
ms	500	500	500	500	500	500	500	500
kVA Start (ΔU = 20% cont. or ΔU = 30% trans.) SHUNT*	45	48	58	79	79	88	104	119
kVA Start (ΔU = 20% cont. or ΔU = 30% trans.) AREP+*	70	75	90	124	124	137	161	171
% Transient ΔU (on-load 4/4) SHUNT - P.F.: 0.8 _{min}	20.7	20.7	20.5	18	19.4	19.6	18.9	19.3
% Transient ΔU (on-load 4/4) AREP+ - P.F.: 0.8 _{min}	15.9	15.9	15.7	14	15	15.1	14.6	15.6
W No-load losses	1051	1047	1121	1270	1270	1300	1513	1642
W Heat dissipation	3603	3764	4184	3867	4620	5061	5489	6275

* P.F. = 0.6 - ** H: SHUNT / AREP+

TAL 042 - Three-phase 25 to 60 kVA - 50 Hz / 31.5 to 75 kVA - 60 Hz

Transient voltage variation 480V - 60 Hz

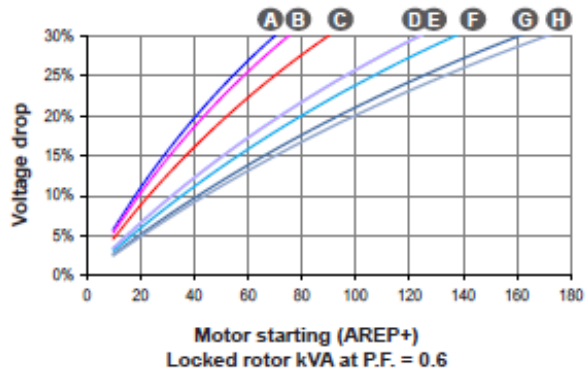
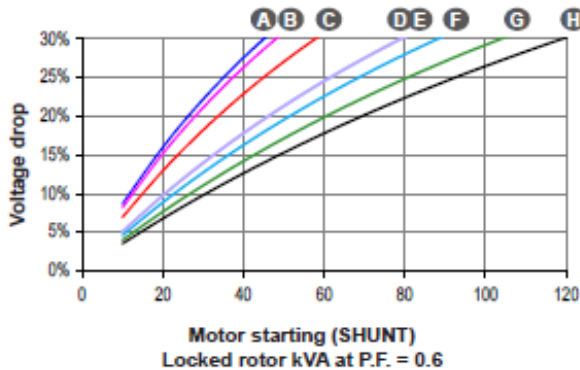
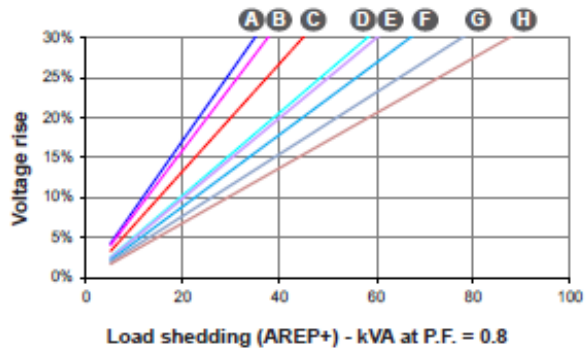
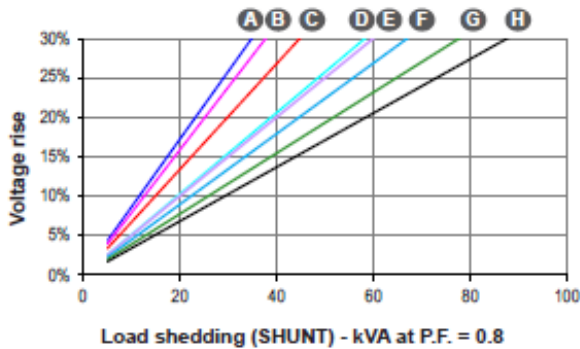
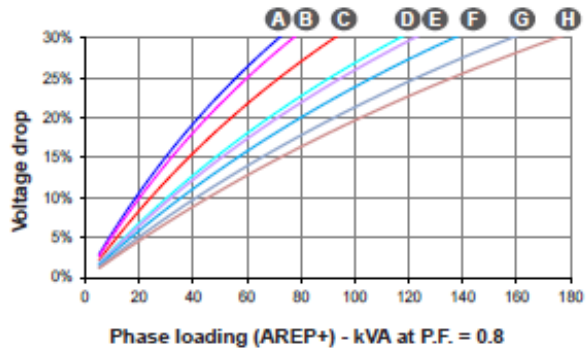
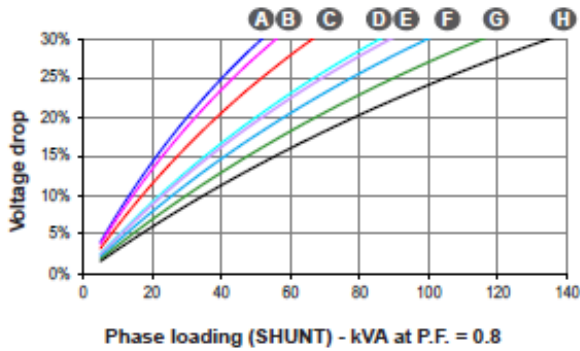

- For a starting P.F. other than 0.6, the starting kVA must be multiplied by $K = \text{Sine P.F.} / 0.6$
- For voltages other than 480V (Y), 277V (Δ), 240V (YY) at 60 Hz, then kVA must be multiplied by $(480/U)^2$ or $(277/U)^2$ or $(240/U)^2$.
- Transient performance of the PMG option, consult us.

TAL 042 - Three-phase 25 to 60 kVA - 50 Hz / 31.5 to 75 kVA - 60 Hz

3-phase short-circuit curves at no load and rated speed (star connection Y)

TAL 042 A

Symmetrical —
Asymmetrical - - -

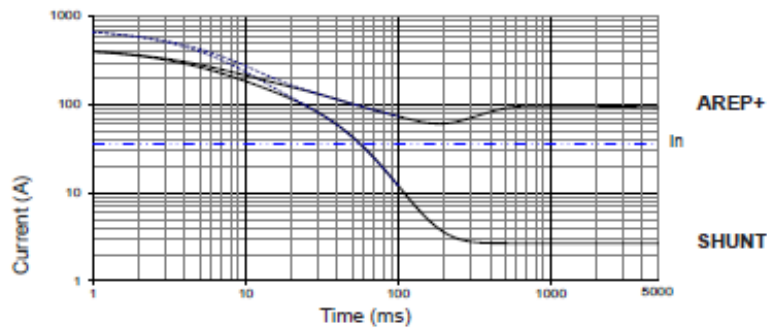

TAL 042 B

Symmetrical —
Asymmetrical - - -

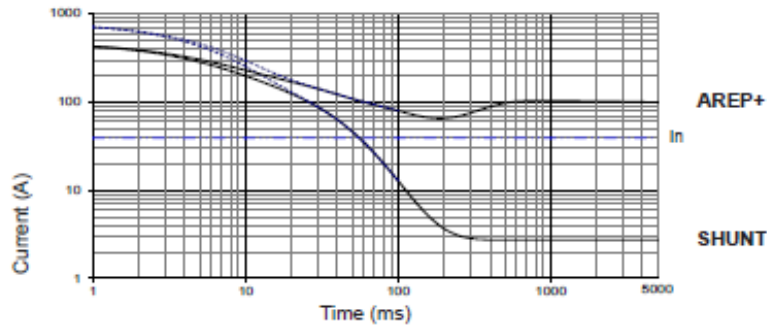

TAL 042 C

Symmetrical —
Asymmetrical - - -

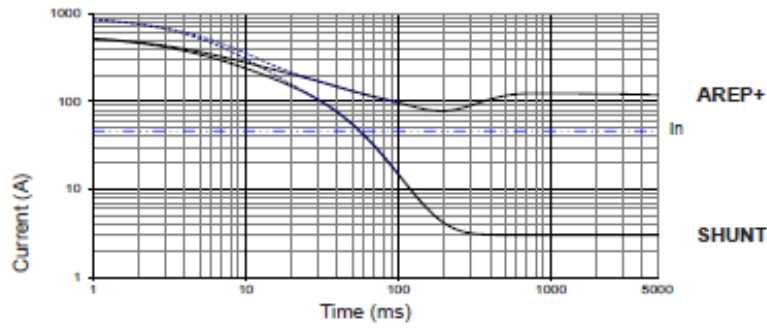

TAL 042 D

Symmetrical —
Asymmetrical - - -

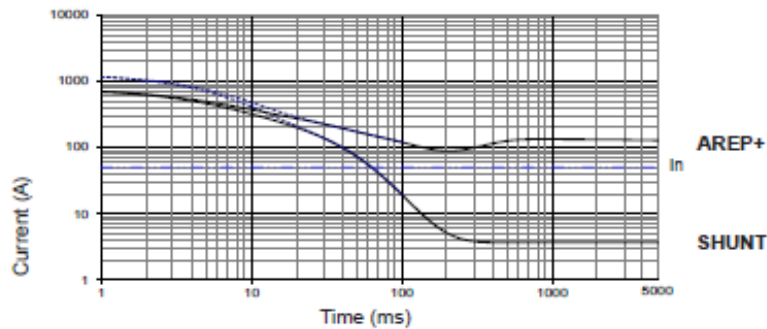

Influence due to connection
For (Δ) connection, use the following multiplication factor:
- Current value x 1.732.

TAL 042 - Three-phase 25 to 60 kVA - 50 Hz / 31.5 to 75 kVA - 60 Hz

3-phase short-circuit curves at no load and rated speed (star connection Y)

TAL 042 E

Symmetrical —
Asymmetrical - - -

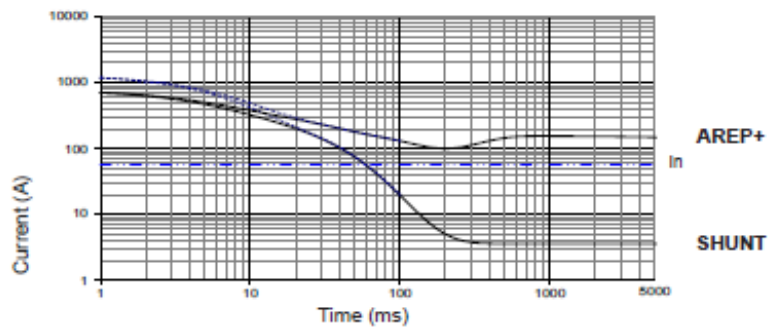

TAL 042 F

Symmetrical —
Asymmetrical - - -

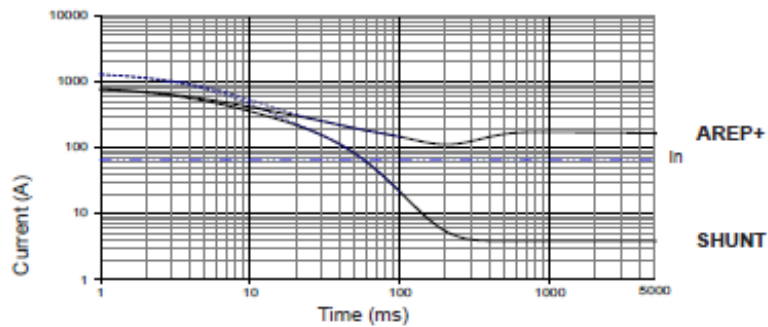

TAL 042 G

Symmetrical —
Asymmetrical - - -

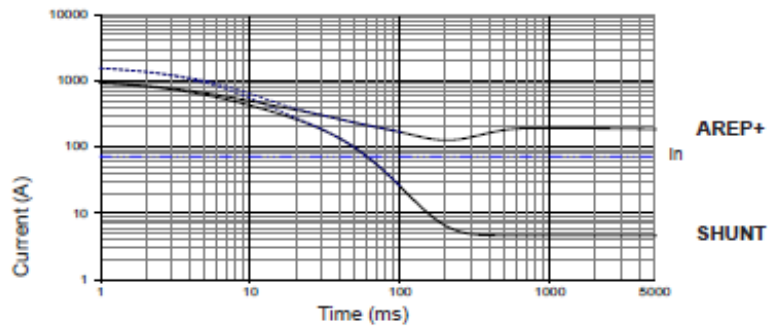

TAL 042 H

Symmetrical —
Asymmetrical - - -

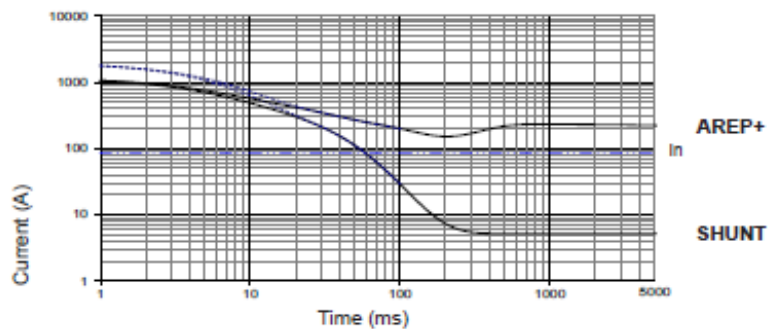

Influence due to short-circuit
Curves are based on a three-phase short-circuit.
For other types of short-circuit,
use the following multiplication factors.

	3 - phase	2 - phase L / L	1 - phase L / N
Instantaneous (max.)	1	0.87	1.3
Continuous	1	1.5	2.2
Maximum duration (AREP+PMG)	1	1.5	

TAL 042 - Dedicated single-phase 18 to 42 kVA - 50 Hz / 23 to 53 kVA - 60 Hz

General characteristics

Insulation class	H	Excitation system	SHUNT
Winding pitch	2/3 (wind. M 50 Hz, M1 60 Hz)	AVR type	R121
Number of wires	4	Voltage regulation (*)	± 1 %
Protection	IP 23	Total Harmonic Distortion THD (**) in no-load	< 3.5 %
Altitude	≤ 1000 m	Total Harmonic Distortion THD (**) in linear load	< 5 %
Overspeed	2250 R.P.M.	Waveform: NEMA = TIF (**)	< 100
Air flow	0.10 m³/s (50 Hz) / 0.13 m³/s (60 Hz)	Waveform: I.E.C. = FHT (**)	< 2 %

(*) Steady state (**) Total harmonic distortion between phases, no-load or on-load (non-distorting)

Ratings / Efficiencies 50 Hz - 1500 R.P.M. - Winding M

kVA / kW - P.F. = 1(*)						
Duty / T° C	Continuous / 40 °C			Stand-by / 40 °C	Stand-by / 27 °C	
Class / T° K	H / 125° K	F / 105° K	H / 150° K	H / 163° K		
Serie (SE)	230 V	η %	230 V	230 V	230V	η %
Parallel (PA)	115 V	η %	115 V	115 V	115 V	η %
TAL 042 A	18	88.1	16.5	19	20	87.4
TAL 042 B	20.5	88.1	18.5	21.5	22.5	87.4
TAL 042 C	22.5	89	20.5	24	25	88.4
TAL 042 D	25	90.6	23	26.5	27.5	90.2
TAL 042 E	28	90.1	25.5	29.5	31	89.6
TAL 042 F	31.5	90.3	28.5	33.5	34.5	89.8
TAL 042 G	35	90.4	32	37	38.5	89.9
TAL 042 H	42	90.5	38	44.5	46	90

(*) For P.F. 0.8: derating 15%

Ratings / Efficiencies 60 Hz - 1800 R.P.M. - Winding M1

kVA / kW - P.F. = 1(*)						
Duty / T° C	Continuous / 40 °C			Stand-by / 40 °C	Stand-by / 27 °C	
Class / T° K	H / 125° K	F / 105° K	H / 150° K	H / 163° K		
Serie (SE)	240 V	η %	240 V	240 V	240V	η %
Parallel (PA)	120 V	η %	120 V	120 V	120 V	η %
TAL 042 A	23	88.3	21	24.5	25.5	87.7
TAL 042 B	26	88.3	23.5	27.5	28.5	87.6
TAL 042 C	29	89	26	30.5	32	88.5
TAL 042 D	31.5	90.4	28.5	33.5	34.5	90
TAL 042 E	36	89.8	33	38	39.5	89.2
TAL 042 F	40	90	36.5	42.5	44	89.5
TAL 042 G	47	90	43	50	51	89.5
TAL 042 H	53	90.5	48	56	58	90

(*) For P.F. 0.8: derating 15%

Starting motor 230V - 50Hz

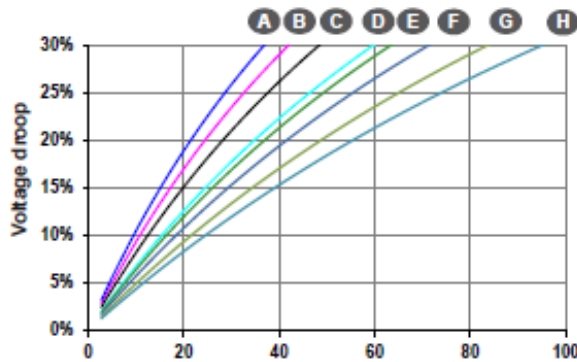

Starting motor 240V - 60Hz

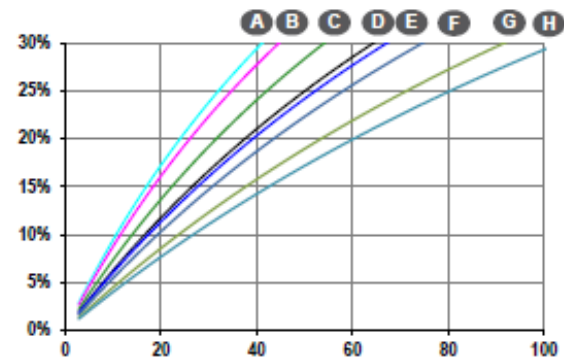

Locked rotor kVA at PF : 0.9

TAL 042 - Three-phase & Single-phase

Single-bearing dimensions

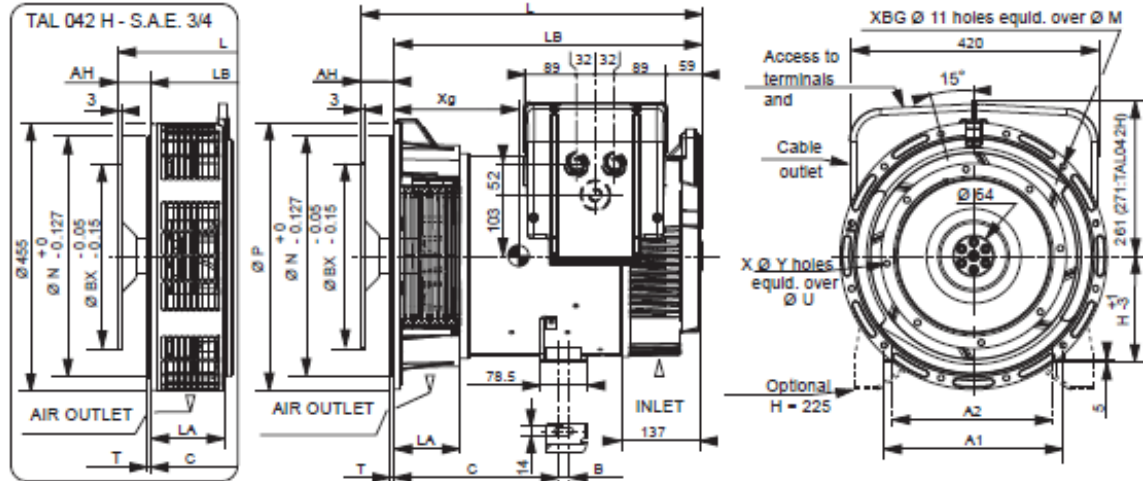

Dimensions (mm) and weight					H = 180 (Standard)				H = 225 (Option)				Coupling		
Type	L maxi*	LB	Xg	Weight (kg)	C	B	A1	A2	C	B	A1	A2	Flange	3	4
TAL 042 A	565	503	237	117	260	18	307	279	209	23	400	350	11 1/2	x	-
TAL 042 B	565	503	242	122	260	18	307	279	209	23	400	350	10	x	x
TAL 042 C	565	503	252	133	260	18	307	279	209	23	400	350	8	-	x
TAL 042 D	610	548	275	165	260	18	307	279	312.5	23	400	350	7 1/2	-	x
TAL 042 E	610	548	275	165	260	18	307	279	312.5	23	400	350			
TAL 042 F	650	588	287	181	260	18	307	279	312.5	23	400	350			
TAL 042 G	650	588	295	186	260	18	307	279	312.5	23	400	350			
TAL 042 H**	680	618	310	187	260	18	307	279	312.5	23	400	350			
TAL 042 H***	703	641	300	195	283	18	307	279	335.5	23	400	350			

* L maxi = LB + AH maxi ** S.A.E. 3 *** S.A.E. 4

Flange (mm)							Flex plate (mm)					
S.A.E.	P	N	M	XBG	T	LA	S.A.E.	BX	U	X	Y	AH
4	406	361.95	381	12	6	122	11 1/2	352.42	333.38	8	11	39.6
3	452	409.58	428.62	12	5	112.5*	10	314.32	295.28	8	11	53.8
-	-	-	-	-	-	-	8	263.52	244.48	6	11	62
-	-	-	-	-	-	-	7 1/2	241.3	222.25	8	9	30.2

* TAL 042 H: 105.3

Torsional analysis data

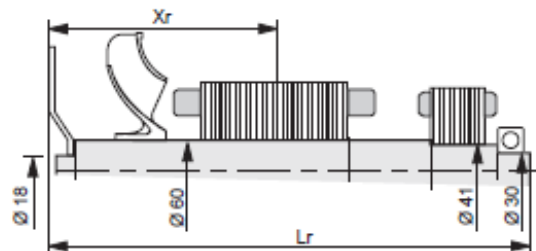

Centre of gravity: Xr (mm), Rotor length: Lr (mm), Weight: M (kg), Moment of inertia: J (kgm²): (4J = MD²)																
Flex plate	S.A.E. 7 1/2				S.A.E. 8				S.A.E. 10				S.A.E. 11 1/2			
	Type	Xr	Lr	M	J	Xr	Lr	M	J	Xr	Lr	M	J	Xr	Lr	M
TAL 042 A	279	526.2	44.1	0.216	277	558	44.4	0.220	274	549.8	44.9	0.211	272	535.6	45.4	0.244
TAL 042 B	282	526.2	46.1	0.229	280	558	46.4	0.233	277	549.8	46.9	0.224	274	535.6	47.4	0.257
TAL 042 C	287	526.2	50.1	0.255	286	558	50.5	0.258	283	549.8	50.9	0.249	281	535.6	51.4	0.282
TAL 042 D	310	571.2	60.2	0.312	308	603	60.6	0.316	306	594.8	61	0.307	304	580.6	61.5	0.340
TAL 042 E	310	571.2	60.2	0.312	308	603	60.6	0.316	306	594.8	61	0.307	304	580.6	61.5	0.340
TAL 042 F	325	611.2	66.2	0.344	323	643	66.5	0.348	321	634.8	66.9	0.339	319	620.6	67.4	0.372
TAL 042 G	330	611.2	69.2	0.364	328	643	69.5	0.367	326	634.8	69.9	0.358	324	620.6	70.4	0.391
TAL 042 H	344	641.2	77.5	0.414	342	673	77.8	0.418	340	664.8	78.2	0.430	338	650.6	78.8	0.442

NOTE : Dimensions are for information only and may be subject to modifications. The torsional analysis of the transmission is imperative. All values are available upon request.